

Power distribution system quadro evo

System Handbook

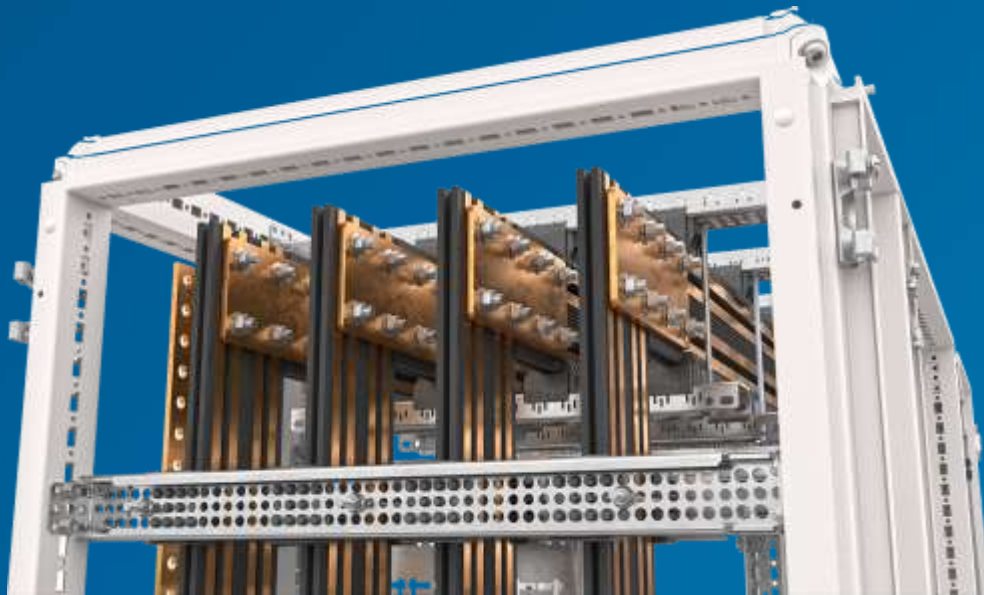

:hager

Table of contents

1	About this manual	6
1.1	Purpose of the manual	7
1.2	Observe related documents	8
1.3	Imprint	9
1.4	Used symbols and trademarks	11
1.5	Abbreviations	12
1.6	General terms	13
1.6.1	Authorised persons	15
1.6.2	Cabinet system for PSC	17
1.6.3	Design and construction of a distribution assembly	18
2	Safety	19
2.1	Intended use	20
2.2	Misuse	21
2.3	General safety instructions	22
2.4	Safety precautions	25
3	quadro evo system presentation and overview	28
3.1	quadro evo overview	29
3.2	General Specifications	32
3.3	Enclosures	33
3.3.1	Cabinet characteristics	33
3.3.2	Component overviews	35
3.3.3	IP30 protection rating	37
3.3.4	IP31 protection rating	41
3.3.5	IP43 protection rating	43
3.3.6	IP55 protection rating	46
3.3.7	Lateral interconnection of cells	49
3.3.8	Side and rear panels	52
3.3.9	Front covers	54
3.3.10	Functional uprights	55
3.3.11	Fixation on horizontal uprights	57
3.3.12	Fixing to the ground	58
3.3.13	Permissible weights	60
3.3.14	Lifting and handling	64
3.3.15	Accessory for enclosure	65
3.4	Busbar and busbar supports	66
3.4.1	Copper manufacturing	66
3.4.2	Mounting and fixation	76
3.4.3	Copper busbar	81
3.4.3.1	Copper busbars, enclosure depth 400 mm - Technical data	83
3.4.3.2	Copper busbars, enclosure depth 600 mm - Technical data	93
3.4.3.3	Copper busbars, enclosure depth 800 mm - Technical data	105
3.4.3.4	Copper busbars and Service Index 223 & 233 - Technical data	129
3.4.4	Aluminium extruded busbar	141
3.4.4.1	Aluminium busbars, enclosure depth 400 mm - Technical data	143
3.4.4.2	Aluminium busbars, enclosure depth 600 mm - Technical data	145
3.4.4.3	Aluminium busbar and Service Index 223 & 233 - Technical data	147
3.4.5	Aluminium busbar accessories	148

3.5	Forms of internal separation	155
3.5.1	Separation parts	155
3.6	Types of functional units	169
3.6.1	Mobility index	169
3.6.2	Service index	170
3.6.3	Service index ratings	171
3.6.4	Service Index ratings of internal system	173
3.6.5	Dedicated parts for Service Index 223 / 233	174
3.7	Functional units	179
3.7.1	Circuit breaker kit product codes	179
3.7.2	MCCB (Moulded Case Circuit Breaker)	180
3.7.2.1	System kits references for fixation of MCCBs in the enclosure.	181
3.7.3	ACB air circuit breaker	215
3.7.4	SWITCH + ATS	217
3.7.5	Fuse LT	225
3.7.6	MCB	226
3.7.7	Mounting plate	227
3.7.8	Cable trunking	228
4	Planning and installation	230
4.1	Standards, verifications and certificates	231
4.1.1	Original manufacturer & SCA manufacturer	233
4.1.2	Design verification according to IEC / EN IEC 61439	234
4.1.3	Routine verification according to IEC / EN IEC 61439	237
4.2	Protection classes for covers	240
4.2.1	Protection classes	241
4.3	Air clearances and creepage distances	243
4.4	Labelling and label panels	246
4.5	Protection against electric shock & continuity of protective conductor circuits	248
4.5.1	Basic definitions	248
4.5.2	Protection classes	250
4.5.3	Network types	251
4.6	Implementing protective conductor and earthing connections in switchgear and controlgear assemblies	256
4.6.1	General information	256
4.6.2	Earthing connection in quadro evo modular stand-alone distributors for rated currents ≤ 250 A	258
4.6.3	Protective conductor measures for rated currents ≤ 630 A	259
4.6.4	Earthing connection in quadro evo modular stand-alone distributors for rated currents ≤ 630 A	260
4.6.5	Protective conductor measures for rated currents > 630 A	261
4.6.6	Earthing connection in quadro evo modular stand-alone distributors for rated currents > 630 A	262
4.6.7	Assignment of minimum cross-sections	263
4.6.8	Protective conductor (PE)	264
4.6.9	Using top-hat rails as protective conductor busbars	265

4.7	Installation of equipment	266
4.7.1	Inserts	266
4.7.2	Removable parts	266
4.7.3	Selecting the equipment	266
4.7.4	Installation of equipment	267
4.7.5	Accessibility	267
4.7.6	Barriers	268
4.7.7	Direction of actuation and indicating switch positions	268
4.7.8	Indicator lights and push buttons	268
4.8	Internal electrical circuits and connections	269
4.9	Connections for conductors inserted from the outside	270
4.10	Insulation properties	272
4.11	Verification of short-circuit resistance	275
4.12	Verification of short-circuit resistance by applying the design rules	280
4.13	Short-circuit resistance of the protective conductor	281
4.14	Electromagnetic compatibility (EMC)	282
4.15	Mechanical function	284
4.16	Maintenance and assembly	285
5	quadro evo technical information and characteristics	286
5.1	Design verification	287
5.2	Verification of temperature rise in low-voltage switchgear and controlgear assemblies	293
5.2.1	Type of enclosure, enclosure materials	293
5.2.2	Conductors and busbars	293
5.2.3	Notes on reducing power loss in enclosures	294
5.2.3.1	Field of application	294
5.2.3.2	Conclusion	295
5.2.4	Verification of temperature rise with the quadro evo system	296
5.2.4.1	Bundling of equipment	297
5.2.4.2	Method 1: Adjusting the power loss (P _v) of built-in equipment with the permissible power loss (P _{perm}) of the enclosures	301
5.2.4.3	Method 2: Determining heating inside the switchgear and controlgear assembly	305
5.2.5	Permissible power loss of enclosures	318
5.2.6	Power loss of busbar systems	326
5.3	Verification by tests of the original manufacturer	328
5.3.1	Incoming enclosures configurations	329
5.3.1.1	Distribution ≤ 630 A 'standard'	330
5.3.1.2	Distribution > 630 A 'transfer'	331
5.3.1.3	Neutral point treatment	332
5.3.1.4	Single incoming	334
5.3.1.4.1	Single ACB incoming compartment	334
5.3.1.4.2	MCCB 800 A ≤ 1600 A incoming	336
5.3.1.4.3	Switch 630 A ≤ 1600 A incoming	337
5.3.1.5	Multiple incoming sources on common busbar	338
5.3.1.5.1	Incoming on multiple MCCB / Switch ≤ 630 A	340
5.3.1.6	Multiple incoming with switch between two busbar systems	342
5.3.1.6.1	Main incoming devices > 630 A	342
5.3.1.6.2	Main incoming devices ≤ 630 A	344

5.3.1.7	Multiple incoming with switch over	345
5.3.1.7.1	Main incoming \leq 630 A from transformer and ATS backup supply	345
5.3.1.7.2	Main incoming $>$ 630 A from transformer and ATS backup supply	346
5.3.1.7.3	Main incoming $>$ 630 A from transformer and ACB backup supply	348
5.3.1.7.4	Main incoming \leq 630 A from transformer and MCCB backup supply	350
5.3.1.8	Multiple incoming with change over	351
5.3.1.8.1	Main incoming $>$ 630 A and ATS to secondary distribution busbar system	351
5.3.1.8.2	Main incoming \leq 630 A and ATS to secondary distribution busbar system	352
5.3.1.8.3	Multiple main incoming $>$ 630 A + coupling + ATS on 3 busbars	353
5.3.1.8.4	Multiple main incoming \leq 630 A + coupling + ATS on 3 busbars	354
5.3.1.8.5	Multiple main incoming $>$ 630 A and ACB backup supply on 2 busbars	355
5.3.1.8.6	Multiple main incoming \leq 630 A and MCCB backup supply on 2 busbars	355
5.3.2	Outgoing enclosures configurations	356
5.3.2.1	Principle of outgoing enclosures configurations	358
5.3.2.2	Outgoing enclosure horizontal orientation of MCCBs	359
5.3.2.2.1	Neutral point treatment	360
5.3.2.3	BS version	365
5.3.2.3.1	Compartmentalized MCCBs	365
5.3.2.3.2	Group mounted version	368
5.3.2.4	Outgoing enclosure vertical orientation of MCCBs	370
5.3.2.5	Outgoing enclosure, modular devices	371
5.3.2.6	Connection and output terminals	373
5.3.2.7	SX compartment	374
5.4	Routine verification	376
5.4.1	Supporting document	378
5.5	Installing	382
5.6	Connections	382
5.7	Commissioning	383
5.8	Maintenance	384
6	Index	385

1 About this manual

Inclosure system component

This manual is part of the quadro evo, Form 4b power distribution system.

Chapter index

Purpose of the manual	7
Observe related documents	8
Imprint	9
Used symbols and trademarks	11
Abbreviations	12
General terms	13

1.1 Purpose of the manual

Users

The manual is intended solely for professionals qualified in electrical installation involved in a project, in particular when they are called in on behalf of a customer, a design department, a system panel builder or an installer.

Objective

This manual applies to the quadro evo, Form 4b power distribution system, containing the following products sold by HAGER:

- quadro evo enclosures,
- Busbar sets,
- Protection, cut-off and control equipment,
- Lighting and power control devices,

(Hereafter called 'the products'.)

It is intended to present the various tested and certified solutions complying with standard IEC / EN IEC 61439-1 / -2 that the quadro evo system can offer in terms of safety, design and operation.

This manual alone is not sufficient for designing and building a project, and other sources of information are required.

1.2 Observe related documents

Accompanying documents

The following documents are applicable components and must always be read in conjunction with this manual. The instructions and notices contained in these documents supplement this system manual and must be observed.

Operator / user

- Installation guides for all components that form part of the system.

Planner

- All the HAGER catalogues containing the technical information on the system.
- Choice, list of distribution components and diagrams defined with the aid of the HagerCad application.

Switchgear manufacturers / electrical engineers

- Installation guides for all components that form part of the system.
- Choice, list of distribution components and diagrams defined and drawings of copper parts defined with the aid of the HagerCad application.
- Power Switchgear and Controlgear Assembly (PSC) checklist.
- PSC Statement of compliance.
- The technical documents for operating the PSC.
- Network calculations
- Distribution diagrams with thermal and magnetic settings of the moulded case circuit breakers.
- Installation guides for all components that form part of the System.

Storing the documents

The manual is an integral part of the system.

- You must read this manual carefully before operating or working on the system and apply the instructions.
- You must pay close attention to and apply clause "safety" and all the safety measures in the other chapters.
- Keep this manual in the immediate vicinity of the System. This manual must be accessible at all times to personnel working on the system.

The owner / operator of the system is responsible for keeping the manual and documents.

1.3 Imprint

Copyright

The content of this manual is protected by copyright. Reprinting, translations and copies of the manual in any form, even in part, require the written consent of the publisher.

Product names, company names, trademarks or registered trademarks are the property of their respective owners and must be treated as such.

The manual does not extend the Sales and Delivery Conditions of Hager. No new claims concerning the warranty and guarantee, which extend beyond the Sales and Delivery Conditions, can be derived from this manual.

Liability note

Hager reserves the right to modify or supplement the product or the documentation at any time without prior notice. Hager assumes no liability for typographical errors and any damage which may arise from them.

Guarantees and responsibilities

The guarantees in force are those of HAGER's general sales and delivery terms

Apart from the guarantee exclusions mentioned there, guarantee rights are also invalidated in the case of:

- damage resulting from defective, unsuitable or non-compliant implementation or use,
- repairs or manipulation by unqualified, unauthorised and / or untrained persons,
- accessories or spare parts not authorised by HAGER being used and resulting in damage.

No new guarantee rights (legal or contractual) or responsibility beyond the general terms of business or delivery of HAGER shall ensue from this manual.

Non-responsibility

HAGER reserves the right to modify the products and / or the documents at any time without notice. HAGER shall not be held responsible for any printing errors and / or consequent damage.

Revisions

Power distribution system quadro evo - System manual

Revision number	Date	Name	Document no.
V2.2	11/2021	M. Zimpfer H. Müller J. Berg	6LE007000B

Contact information

Hager Electro GmbH & Co. KG

Zum Gunterstal

D-66440 Blieskastel

Tel. +49 06842 945 0

Fax +49 6842 945 4625

Email info@hager.de

hager.com

1.4 Used symbols and trademarks

Structure of warning messages

 Signal word
Type and source of the danger! Consequences if the danger is ignored <ul style="list-style-type: none"> ➤ Measures for averting the danger



Danger levels in warning messages

Colour	Signal word	Consequences of non-compliance
	DANGER	Death, serious personal injury
	WARNING	Death or serious personal injury possible
	CAUTION	Personal injury
	ATTENTION	Property damage

Procedural instructions with a fixed order:

Step	Action
1	Procedural instruction step 1
2	Procedural instruction step 2

Additional symbols and their meaning

Symbol	Meaning
	The work must only be performed by an electrically skilled person.
	The product is intended for indoor installation or indoor use.

Lists and instructions

Visual representation	Meaning
1., 2., 3., etc.	Numbered lists with a fixed order
-	Lists and procedural instructions without a fixed order
➤	Measure / procedural instruction for averting danger

1.5 Abbreviations

Abbreviations used in this manual

Abbreviation	Description
UPS	Uninterruptible Power Supply
PSC	Power Switchgear and Controlgear Assembly
IP	Ingress Protection rating
IK	Resistance to external mechanical impacts
SR	Service Rating
DB	Distribution Board
LVMDP	Low Voltage Main Distribution Panel
ZVT	Zero Voltage Test

Abbreviations used in standard IEC / EN IEC 61439-1 / -2

Abbreviation	Description
EMC	Electromagnetic compatibility
SCPD	Short circuit protection device
CTI	Comparative tracking index
VLV	Very low voltage
f_n	Rated frequency
I_c	Short - circuit current
I_{cc}	Rated conditional short - circuit current
I_{cp}	Prospective short - circuit current
I_{cw}	Rated short - time withstand current
I_{nA}	Assembly rated current
I_{nc}	Current rating of a circuit
I_{ng}	Group rated current of a main circuit
I_{pk}	Admissible peak current rating
N	Neutral conductor
PE	Protective earth
PEN	Protective earth and neutral
RDF	Rated diversity factor
SPD	Surge protection device
U_e	Rated operational voltage
U_i	Rated insulation voltage
U_{imp}	Rated impulse withstand voltage
U_n	Rated voltage

1.6 General terms

User group

The quadro evo system is designed for constructing power distribution assemblies according to standards IEC / EN IEC 61439-1 / -2.

The respective responsibilities of each party are stated in standard IEC / EN IEC 61439-1:

Project	Responsibility according to IEC / EN IEC 61439-1
Design office, engineering	Establishes the functional requirements of a distribution assembly according to the black box principle: <ul style="list-style-type: none"> - type of connection to the electricity mains - number of circuits and consumption points - installation or environmental conditions - operation, servicing and maintenance
Original manufacturer	Responsible for the original design and associated verification of an assembly complying with standards IEC / EN IEC 61439-1 / -2.
Assembly manufacturer	Builds the assembly and is responsible for supplying the assembly documentation and supporting documentation.
User	Accepts an assembly according to standard IEC / EN IEC 61439-1 / -2, appoints an operation manager <ul style="list-style-type: none"> - arranges training for the operating personnel - assesses the risks - takes the necessary steps to ensure the safety of persons

Original manufacturer

The original manufacturer builds the system and is responsible for its design. He is obliged to comply with the requirements of standard IEC / EN IEC 61439-1 / -2 and with all the design verifications listed under the PSC standard.

Heating limit verifications can be by test or calculation or by deduction in comparison to a similar variant already tested.

N.B.: For installations of over 1600 A, heating limit verifications must be carried out by tests.

The manufacture or assembling of the power assembly can be carried out by persons other than the original manufacturer.

Assembly manufacturer

The assembly manufacturer (generally the panel builder) builds the assemblies in conformity with the specifications and rules of the original manufacturer.

The assembly manufacturer has to carry out individual series tests on each assembly to detect any material defects and to ensure that the assembly functions properly.

The identification and documentation of the system form an integral part of the supply of the assembly, together with the declaration of conformity and the routine verification test report.

NOTICE

If an assembly manufacturer modifies or does not observe the original manufacturer's instructions, then the assembly manufacturer is considered as the original manufacturer and must carry out all the tests.

This constraint also applies when the assembly manufacturer substitutes equipment or components by third party equipment.

User

Party who specifies, purchases, uses and / or operates the assembly, or any person acting on their behalf.

Design office

As the representative of the user, the design office establishes the functional requirements of the distribution assembly on the black box principle in terms of its supply and outgoing circuits, without any knowledge of its internal design.

1.6.1 Authorised persons

Authorised person

Skilled or instructed person who has been granted the authorisation to carry out the defined work.

Skilled person

A skilled electrician possesses knowledge and experience on electrical equipment arising from specialist training and, with knowledge of the applicable standards and regulations, is able to assess the work with which he is entrusted and detect and avoid possible risks.

Instructed person

Person sufficiently informed or supervised by electrically skilled persons to enable him to appreciate the risks and avoid electrical hazards.

Supplementary training for instructed persons

For the following jobs, the initial knowledge is often insufficient and the persons need to be specifically trained in this work.

- Cleaning electrical equipment (when the assembly is switched off).
- Working near live parts.
- Checking for zero voltage.
- Working on equipment near active parts.
- Testing equipment with the appropriate test equipment.

Precautions and restrictions for instructed persons

Instructed persons may only carry out a job when a qualified electrician has first validated the work and authorised access to the assembly.

When working near live parts, it is obligatory to wear personal protection and to use appropriate tools.

Modifications and servicing are out of scope of instructed persons.

Modifications and servicing are carried out only by a skilled person.

Ordinary person

Person who is neither a skilled person nor an instructed person.

Electrical operations manager

Person responsible for operating (running, using, servicing, maintenance, troubleshooting, surveillance, access, etc.) of a construction or electrical installation.

Work must be planned



All work on the assembly must be planned. After analysing the jobs and assessing the risks, one of the following three working methods can be chosen:

- Working offline
- Working near live parts
- Working live

Working offline is basically the safest and most efficient way of working on electrical installations.

- Clearly identify and signal the working zone and the electrical supply.
- Before working on the equipment, observe the following 5 safety rules.

Electrical hazards

 DANGER	
	<p>An electric shock results in serious burns and life-threatening injuries and even death.</p> <ul style="list-style-type: none">➤ Prior to starting work on the system, observe the following 5 safety rules: <ol style="list-style-type: none">1. Disconnect completely (all poles and all sides).2. Secure against reconnection.3. Verify the absence of voltage.4. First earth and then short-circuit.*5. Cover or shield any adjacent live parts.

* When working on low-voltage systems, the step for earthing and short-circuiting the system may only be omitted if there is no danger of voltage transmission or feedback.

1.6.2 Cabinet system for PSC

Empty enclosure

Planned self-supporting structure:

- For the support and installation of electrical and electronic equipment,
- To protect this equipment from external influences (shocks, weather, corrosion, etc.),
- To protect persons from electrical shocks.

Cabinet / electrical distribution system

quadro evo enclosures are used to build power switchgear.

A cabinet system is a set of adjacent cabinets carrying the electrical and electronic equipment installation.

Hager is the original manufacturer and offers a range of mechanical and electrical combinations for building power switchgear systems for power distribution.

If the original manufacturer's instructions and assembly guides are scrupulously followed and these assemblies comply with IEC / EN IEC 61439-1 / -2.

System components

A complete range of electrical and mechanical components, enclosures, busbars, functional units etc. as defined by the original manufacturer and that can be assembled by following the original manufacturer's instructions to build various assemblies.

Assembly of power switchgear systems for power distribution

Assemblies of power switchgear systems for power distribution are developed, manufactured and certified according to the requirements of standard IEC / EN IEC 61439-1 / -2. Switchgear assemblies are also called power distribution systems. Power distribution assemblies are intended for low voltage industrial, commercial and similar applications. The standard IEC / EN IEC 61439-2 does not provide for the use of the system by ordinary persons.

Switchgear assemblies are used to distribute electrical power for all types of load and control. The nominal voltage does not exceed 1000 VAC or 1500 VDC. They are at the centre of the main distribution and are crucially important to the functional safety of the electrical installation.

1.6.3 Design and construction of a distribution assembly

IEC / EN IEC 61439-1 / -2

The design, assembly and installation, tests and documentation of a PSC must comply with the applicable provisions of standard IEC / EN IEC 61439-1 / -2.

There are generally five main steps in the design and construction of a power switchgear assembly.

Step	Action
1	<p>Statement of the need</p> <p>The customer must precisely specify the main characteristics of the assembly in its environment.</p> <p>He must state:</p> <ul style="list-style-type: none"> - the context of use of the equipment, - the external constraints related to its environment, - The storage and transport conditions.
2	<p>Design phase</p> <p>The manufacturer of the assembly interprets the need and provides a suitable technical solution. The manufacturer of the assembly must respect the instructions for use of the original manufacturer. If the assembly manufacturer does not use original manufacturer's certified tested parts, the switchgear assembly manufacturer must arrange and provide complete testing of the design.</p>
3	<p>Construction phase</p> <p>The switchgear assembly is assembled in accordance with the equipment manufacturer's instructions and documentation. Hager is the original manufacturer of the quadro evo power distribution system.</p>
4	<p>Testing phase</p> <p>The assembly manufacturer carries out routine tests on each manufactured assembly.</p>
5	<p>Documentary phase</p> <p>The assembly manufacturer draws up the EC declaration of conformity documentation, referring to the test certificates and ensures documentary traceability.</p>

System

Rated voltage U_n	up to 415 V
Rated operational voltage U_e	up to 415 V
Rated insulation voltage U_i	up to 1000 V
Rated impulse withstand voltage U_{imp}	up to 12 kV
Rated frequency f_n	50 / 60 Hz
Rated short-time withstand current I_{cw}	up to 85 kA / 1 s
Rated peak withstand current I_{pk}	up to 187 kA
Mechanical impact protection	IK08 without door / IK10 full door or transparent door
Internal form of separation	1 / 2b / 3b / 4b
Compliant with	IEC / EN IEC 61439-1 / -2
Degree of protection of enclosure	IP30 / IP31 / IP43 / IP55
Depth of the enclosure (outer dimensions)	400 / 600 / 800 mm
Width of the enclosure (outer dimensions)	450 / 700 / 900 / 1000 mm
Height of the enclosure (outer dimensions)	1900 / 2100 mm

2 Safety

Read carefully

- Observe the safety information in the operating instructions of the components used.
- The information about intended use as provided in this chapter should also be taken into account.

The safety-related information is provided to help you identify and avoid risks in good time. It is the prerequisite for safe assembly and use of the quadro evo, Form 4b power distribution system.

Chapter index

Intended use	20
Misuse	21
General safety instructions	22
Safety precautions	25

2.1 Intended use

quadro evo distribution system

The quadro evo distribution system is a design-verified low-voltage switchgear and controlgear assembly in accordance with the standard IEC / EN IEC 61439-1 / -2.

The system can be used to construct low voltage distribution systems supplying up to 4000 A.

Fixed indoor installation

The quadro evo enclosures are intended for fixed indoor installation. They are permanently installed and operated in a closed electrical operating compartment according to clause 7.1 of standard IEC / EN IEC 61439-1 at the installation site.

Preventing operation by unauthorised persons

If the enclosure is not operated in a closed electrical operating site, switching operations and access to the open switching enclosure by unauthorised personnel must be prevented. The enclosure must then be lockable using a lock or tools must be required to open it.

No operation by laypersons

Unqualified persons may not service or operate the units.

Intended use also includes:

- Reading and observing this manual along with any instructions provided with the system components (where available).
- Complying with the safety regulations.

2.2 Misuse

Use only in accordance with these instructions

Any use not in strict accordance with the instructions in this manual or document, or any prolonged use under overload constitutes non-compliant use.

Hager does not assume any liability for damages resulting non-compliant use.

Danger due to electric shock or arc faults in case of non-compliant use

Non-compliant use can result in high voltages and high currents, which can lead to dangerous situations. This may result in serious injuries and even death.

- The product must not be used in areas for which the product is not designed.
- Never operate the product outside the specifications as provided in the Technical Data.
- Observe the instructions for extension and the upscaling regulations.
- Always observe the requirements for personnel qualifications.

2.3 General safety instructions

Electrical hazards

⚠ DANGER	
	<p>An electric shock results in serious burns and life-threatening injuries and even death.</p> <ul style="list-style-type: none"> ➤ Prior to starting work on the system, observe the following 5 safety rules: <ol style="list-style-type: none"> 1. Disconnect completely (all poles and all sides). 2. Secure against reconnection. 3. Verify the absence of voltage. 4. First earth and then short-circuit.* 5. Cover or shield any adjacent live parts.

* When working on low-voltage systems, the step for earthing and short-circuiting the system may only be omitted if there is no danger of voltage transmission or feedback.

Minimum qualifications of specialist personnel: electrician / electrically skilled person with appropriate testing experience

Only qualified electricians may select, assemble, install, operate, test, maintain, dismantle, and dispose of components of the enclosure system.

Personnel qualification requirements

Project steps and phases	Training, qualification or experience
Design	Draughtsman, electrician supervisor, panel builder, qualified electrician
Assembly, wiring	Panel builder, qualified electrician
Transport	Carrier
Handling	Handler
Assembly, connection	Qualified electrician and informed person
Commissioning	Authorised electrician with experience in inspection and commissioning
Operation	Authorised electrician and authorised competent person
Cleaning	Authorised electrician and authorised competent person if the installation is switched off
Modification, extension	Draughtsman, qualified electrician
Troubleshooting	Authorised electrician
Servicing and maintenance	Authorised electrician with experience in inspection and commissioning
Switching off	Authorised electrician
Dismantling	Authorised electrician and authorised competent person
Recycling	Qualified electrician and competent person

Personal protective equipment

When working on the system, appropriate personal protective equipment should be worn.

This equipment according to employment law must be in perfect condition and comply with the regulations in force.

Below is the minimum equipment that must be available to each person working on the system:

- Helmet with integral visor
- Insulating gloves
- Work clothes
- Safety shoes
- Floor mat

The protective equipment must be inspected before and after each job; in addition, it must be periodically checked by qualified persons.

Obligations of the operator / user

The user responsible for the PSC must ensure that:

- The system is used in accordance with the characteristics provided and operated in perfect working condition.
- The safety devices are regularly inspected and functional.
- The personal protective equipment required for the accredited personnel is available and is used during jobs.
- The manual and the other guides must always be accessible to personnel working on the system, in perfect condition and kept updated.
- All the phases, installation, connection, commissioning, operation, shut down, maintenance, dismantling, recycling are carried out by qualified personnel.
- The safety instructions or warnings are in place and in perfect condition.

Concept of safety / risk assessment

The responsible operator of the PSC must draw up a training and safety plan. The purpose of this plan is to train and instruct the persons in charge of operating the system.

Training sessions for persons with access to the operating zone must be held regularly. The time between two training sessions depends:

- On the level of training of the persons concerned.
- The work to be done.
- The cabinet configuration.

The training must cover at least the following subjects:

- The hazards incurred when approaching live parts and the protective measures against accidental contact, with devices such as cover, barrier, safety distance.
- Emergency measures and assistance protocol in case of accident.
- Evacuation and access zones for emergency services, signing of emergency exits.
- The operating method for the system.
- The procedure in case of fire.
- The procedure in case of excessive humidity or water damage.

The responsible user of the PSC can appoint a work supervisor before the work to carry out preparatory work:

- Job analysis
- Risk assessment
- Introducing safety measures and protective and work equipment necessary
- Checking the qualification and authorisation of personnel for the work to be done.

Observe residual energies and static discharge

Prior to starting activities during installation work, disconnect the system and make sure it is statically discharged before touching the devices. Static voltages can result in personal injuries.

Notes about connections, devices and functional earth

- The functional earth (FE) must be connected to the protective earth (PE) or the potential equalisation. The installer is responsible for establishing this connection.
- Connection and signal lines must be installed so that inductive and capacitive interference do not adversely affect the automation functions.
- The automation technology devices and their controls must be installed so that they are protected against unintentional operation.
- Ensure that the low voltage for the 24 volt supply features safe electrical isolation. Only power supply units that fulfil the requirements of the IEC 60364-4-41 HD 60364-4-41 (DIN VDE 0100-410) may be used.

2.4 Safety precautions

Safety precautions

Electrical hazards are often under-estimated, even by qualified electricians. To avoid accidents that may cause serious injuries or death, the safety instructions must be observed.

It is essential to observe the following safety rules:

- Protect yourself against the effects of a current passing through the body (risk of electric shock, internal burns, ventricular fibrillation)
 - Protect yourself against the effects of electric arcs (dazzling, projection of material, intoxication by gas or dust).
 - Observe the installation instructions provided with the various products.
- These give information for completely safe assembly.
 - Observe the assembly and installation instructions in this manual.
 - Observe the characteristics and conditions of use given for the configuration and design of the system. Inappropriate use, outside or beyond the stated characteristics can cause malfunctioning and major risks to the installation and to persons.

Residual energy, backup source and electrostatic discharges

- Some equipment (AC/DC or other) is equipped with a reserve energy system, and similarly there may be autonomous (UPS, electricity generator) or photovoltaic sources in the assembly.
- Before carrying out any work, it is essential to make safe the working zone.
- Before working on equipment, prepare for risks related to electrostatic discharges from certain equipment.

Remarks concerning connections of the assembly

- The equipotential bonding busbar must be connected through a protection conductor to the main earth terminal or busbar of the installation. This must be carried out by the installer.
- Route and separate the signal or data transmission cables from the power cables. Install the communication cables as close as possible to the mounting plates.

Main network tolerances

- Note the operating tolerances of the assembly.
- Differences in voltage from the nominal value must not exceed the admissible limits stated in the technical data. Exceeding these nominal values may cause malfunction or even dangerous operation.

Risk of electric shock close to live parts!

The dangerous proximity of live parts is often underestimated.

Electric shocks can result in burns and serious or fatal injuries.

- Take care when approaching live parts.
- Signal the working zone with protection to keep away persons.
- Protect yourself by covering live parts with insulating mats or covers for the entire duration of the work.
- Use insulated tools suitable for the job to protect you from any accidental contact.
- Before working, make sure that live parts have been made safe and that they cannot be touched accidentally.

Operation of the system solely by authorised persons

The PSC shall only be operated by qualified persons accredited for working in proximity to live parts, trained in safety measures and acquainted with the manual and knowing how to work accordingly.

Each time, before the system is switched on, ensure that:

- The conditions and authorisations for access to the room are clearly defined.
- There are only authorised persons in the vicinity of the assembly.
- Nobody can be injured by starting up the system.

Each time, before switching on:

- Check that the system has not been damaged.
- Make sure the switchgear is in good condition and suitable for use.
- Report any faults immediately to your management.
- Remove any materials or objects from the working zone if they are not needed for operation.

Risk of electric shock of capacitors

In reactive energy compensation systems, you should be careful in case there is residual energy in capacitors, even after switching off.

Electric shocks can result in burns and serious or fatal injuries.

- Wait at least 5 minutes after disconnecting capacitors. After this time, carry out a ZVT.
- Only then can service and maintenance work be carried out.

One month after the reactive energy compensation system has entered into service, all the connections should be inspected and tightened to the stated torques.

To ensure the long life and efficiency of the compensation system, we recommend annual maintenance inspections. Refer to and observe the instructions for inspection and maintenance.

Risk of accident while working in the area around the system

While working on fitting or connecting cables at the cabinets there may be a risk of accidents.

- Before carrying out any work carry out a risk analysis.
- Before working, draw up a lockout form: there is no room for improvisation.
- Observe the 5 safety rules.
- Only qualified and accredited personnel may work in the vicinity of cabinets.
- When working at height, it is forbidden to climb on cabinets; use ladders, scaffolding or any other suitable means, but under no circumstances use the cabinets as a support. The structure and trim are not designed to support the weight of a human body. If the panels are deformed, this may cause arcs or short circuits.
- Protect yourself against the risk of falling.
- Protect the cabinets from risks of liquid or material projections and switch off equipment before working, observing the 5 security rules.

Periodic inspection and maintenance

Regular inspection and maintenance of the PSC are important for the safety of persons and continuity of service.

Observe the inspection and maintenance intervals mentioned in this manual together with the guides and documents for components of the system.

The interval can be shortened according to the operating or environmental conditions if necessary.

Take the necessary measures to avoid humidity, condensation, liquid and dirt penetration, or shocks that may interfere with the operation of the assembly.

Inspect to check that there is no possibility of switching on the PSC without authorisation.

Close off access to the working zone for unauthorised personnel before carrying out maintenance on the system.

Replacing equipment or extensions to the cabinet

Before replacing electrical equipment by other types or before any extension of the assembly, a survey and verification of the assembly should be carried out in conformity with standard IEC / EN IEC 61439.

In the case of modification or replacement of the assembly by configurations not provided for by the original manufacturer "Hager", the constructor of the assembly then becomes the original manufacturer and must carry out all the design checks, routine checks no longer being sufficient.

Extension or re-equipping of a cabinet

All extensions or upgrades must be subject to a survey and take into account the information in the manual or other guides.

The extension or modification of an existing installation must not degrade and affect the safety of the existing system.

3 quadro evo system presentation and overview

Presentation and overview of the power distribution system quadro evo.

Chapter index

quadro evo overview	29
General Specifications	32
Enclosures	33
Busbar and busbar supports	66
Forms of internal separation	155
Types of functional units	169
Functional units	179

3.1 quadro evo overview

The switchboard as the focal point of any electrical installation

The LV switchboard is what makes the system smart. As it is the place where energy arrives and the hub for distributing the energy to the site applications, the switchboard is an essential component of any electric installation.

The switchboard is vital for power availability and provides the additional benefit of protection against personal injuries and property damage. Certain rules must be followed in the construction, design and assembly of a switchboard, which are stipulated in the IEC / EN IEC 61439 standard. The standard's purpose is to harmonise the definition of low-voltage switchgear and controlgear assemblies and, thus, to make sure that all switchboard equipment reaches the necessary performance levels. For example, the standard defines:

- the distinct responsibilities of OEM (original equipment manufacturer), the company that designed and verified the equipment, and the assembly manufacturer who is responsible for the finished assembly;
- a benchmark for product certification by determining rules for design and verification.

The IEC / EN IEC 61439 standard applies to all components of an electrical switchboard. When a device is manufactured in compliance with this standard, it offers maximum safety and reliability of the system in which it is installed.

quadro evo - reliable switchboards

We carry out a series of tests to ensure the quadro evo switchboard has the following characteristics:

- all components are Hager low-voltage equipment compliant with the relevant standards,
- compliant with catalogue configurations,
- all mechanical and electrical components from the quadro evo product line have been verified by the OEM,
- has been tested according to individual requirements.

Hager provides the panel manufacturer with all that is needed to create verified quadro evo switchboards, e.g. a catalogue with basic configurations for low-voltage distribution, complete documentation of switchboard design and mounting as well as software for calculating and design.

It is the Hager responsibility to ensure conformity with the IEC / EN IEC 61439-2 standard and Hager also ensures the quality by independent laboratories that carry out design verification on equipment supplied by Hager. The resulting certificates of conformity serve as proof for the equipment's compliance. Hager must ensure the equipment is subjected to specific routine verification and must provide the resulting declarations of conformity.

The safety benefits of quadro evo

- Compliance with IEC / EN IEC 61439-2 standard,
- Tested safety guaranteed during the switchboard's entire lifecycle,
- Easy, standard-compliant upgrading for a sustainable investment,
- Guaranteed compliance with the technical specifications.

quadro evo ensures creating safe, optimized switchboards that consist entirely of Hager components:

- Optimized ratings of all components (e.g. switchgear, distribution blocks, pre-assembled connectors),
- Inter-compatibility of all components,
- Seamless testing of all switchboard configurations.



Straightforward switchboard design

The quadro evo functional system is suitable for any kind of low-voltage distribution switchboard up to 4000 A and can be used in both commercial and industrial environments.

- Metal framework:
The switchboard consists of either one or several frameworks that are arranged next to each other or back-to-back. These frameworks serve as the basis for mounting cover panels and doors.
- Distribution system:
Electricity is distributed throughout the switchboard by means of horizontal or vertical busbars that are located at the side, top or bottom of the enclosure.
- Functional units:
Complete functional units comprise a plate specifically intended for device installation and a front cover that provides additional safety and aesthetic by preventing live parts from being touched. Furthermore, there are prefabricated kits to realize different busbar configurations, as well as devices for connections on site.

Each functional unit provides the switchboard with an additional functionality.

The functional units are designed according to a modular approach and are positioned in a sensible manner. All elements needed for mounting functional units are included.

All quadro evo components and, particularly, all parts of the functional units have been tailored to the device characteristics and have been tested accordingly.

To build segregation forms 2, 3 or 4, additional accessories are available to create internal partitions or barriers that prevent touching of live parts.

3.2 General Specifications

Electrical specifications

Compliant with standards	IEC / EN IEC 61439
Rated insulation level (main busbars)	1000 V
Rated current (I_{nA})	4000 A
Rated peak withstand current (I_{pk})	187 kA
Rated short-time withstand current (I_{cw})	85 kA / 1 s
Frequency	50 / 60 Hz
Rated operating voltage (U_n)	415 V

For further information, see instruction leaflet.

Electrical switchboards that are based on the quadro evo system and recommendations by Hager fulfil all requirements of the international IEC / EN IEC 61439-1 / -2 standards.

Mechanical specifications

Material	Sheet metal (steel) Cataphoresis-painted surface and hot-polymerized polyester (epoxy powder coating) Non-painted parts, such as mounting plates: galvanized sheets
Colour	RAL 9010 (white) RAL 7035 (light grey)
Application	Enclosures for indoor use
Degree of protection	IP30 with corresponding cover panel IP31 with front door and ventilation IP43 with modular doors IP55 with corresponding cover panel, including a door
Impact resistance rating	IK08 with covering frame IK10 with IP55 door
Framework widths (internal / external)	300 mm (cable compartment) 350 mm / 450 mm 600 mm / 700 mm 800 mm / 900 mm 600 mm + 300 mm / 1000 mm
Framework heights (internal / external)	2000 mm / 2100 mm 1800 mm / 1900 mm
Framework depths (internal / external)	350 / 400 mm 550 / 600 mm 750 / 800 mm
Cabinet	Flatpack delivery
Possible configurations	Side by side, back to back, corner

3.3 Enclosures

3.3.1 Cabinet characteristics

External dimensions

These are steel panel enclosures for indoor use with external dimensions:

Width [mm]	Height [mm]	Depth [mm]
450	1900 or 2100	400 / 600 / 800
700	1900 or 2100	400 / 600 / 800
900	1900 or 2100	400 / 600 / 800
1000	1900 or 2100	400 / 600 / 800

Further specifications

- The enclosures can be installed with IP30, IP31, IP43 or IP55 rated protection.
- The door opens to 120°.
- Colour RAL 9010 for the body, RAL 7042 for the plinths.
- Paintwork: Cataphoresis treatment followed by hot polymerised polyester epoxy powder coating, smooth finish.
- Polyurethane seal on doors, rear and side panels.
- Storage temperature -40 °C to +80 °C.
- Operating temperature -5 °C to +40 °C.

Material thickness of the cover

	Thickness [mm]
Cabinet structure (upright), lower and upper parts, door	15 / 10
Side panel depth 400 / 600 mm	12 / 10
Side panel depth 800 mm	15 / 10
Rear panel length 300 / 450 mm	12 / 10
Rear panel length 700 / 900 / 1000 mm	15 / 10
Plinth	20 / 10

Frame reference codes

Width [mm]	Height [mm]	Depth [mm]	Top / bottom frame	Uprights	Plain plate	Sliding plate	Plinth H100	Vertical spars for subdivision	Horizontal spars for subdivision	Functional Uprights
450	x	400	FN018EW*	x	FN078E	FN098E	FN438E	x	FX289	x
700	x	400	FN021EW*	x	FN081E	FN101E	FN441E	x	FX289	x
900	x	400	FN023EW*	x	FN083E	FN103E	FN443E	x	FX289	x
1000	x	400	FN024EW*	x	FN084E	FN104E	FN444E	x	FX289	x
450	x	600	FN020EW*	x	FN080E	FN100E	FN440E	x	FX291	x
700	x	600	FN029EW*	x	FN089E	FN109E	FN451E	x	FX291	x
900	x	600	FN031EW*	x	FN091E	FN111E	FN453E	x	FX291	x
1000	x	600	FN032EW*	x	FN092E	FN112E	FN454E	x	FX291	x
450	x	800	FN022EW*	x	FN082E	FN102E	FN442E	x	FX292	x
700	x	800	FN013EW*	x	FN073E	FN093E	FN433E	x	FX292	x
900	x	800	FN017EW*	x	FN077E	FN097E	FN437E	x	FX292	x
1000	x	800	FN037EW*	x	FN121E	FN117E	FN459E	x	FX292	x
x	1900	x	x	FN046EW*	x	x	x	FN286EW	x	UC1800FB
x	2100	x	x	FN047EW*	x	x	x	FN287EW	x	UC2000FB

* W for RAL 9010 (white), G for RAL 7035 (light grey)

3.3.2 Component overviews

450 mm wide cell



The **450 mm wide cell** can be used to incorporate components for electrical distribution, busbars, or as a cable compartment. This cabinet width enables 10 modular units to be fitted per row.

Height [mm]	Depth [mm]		
	400	600	800
1900 or 2100			
1	Uprights		
2	Side panel		
3	Top / bottom frame		
4	Rear panel		
5	Plain / sliding cover plate		
6	Door		
7	Plinth		

700 or 900 mm wide cells



700 or 900 mm wide cells can be used to incorporate components for electrical distribution. These cabinet widths enable 24 (700) and 36 (900) modular units to be fitted per row.

Height [mm]	Depth [mm]		
	400	600	800
1900 or 2100			
1	Uprights		
2	Side panel		
3	Top / bottom frame		
4	Rear panel		
5	Plain / sliding cover plate		
6	Door		
7	Plinth		

900 or 1000 mm wide cells



900 or 1000 mm wide cells can be used to incorporate components for electrical distribution (width 700 mm) and busbars or for cable compartments of width 200 or 300 mm.

This cabinet width enables 24 modular units to be fitted per row.

Height [mm]	Depth [mm]		
	400	600	800
1900 or 2100			
1	Uprights		
2	Side panel		
3	Top / bottom frame		
4	Rear panel		
5	Plain / sliding cover plate		
6	Door		
7	Plinth		

3.3.3 IP30 protection rating

General information

In the IP30 version, quadro evo cabinets are supplied without a door.

Impact resistance is IK08. To achieve the thermal dissipation values given in the charts for IP30, additionally natural ventilation panels must be used to achieve the desired thermal ratings.

To achieve the needed ventilation, follow the instructions below, louvred panels can be placed in the lower part of the cabinet to admit fresh air, and a louvred top on the upper part to ensure good air circulation.

IP30 without front door and with top supply

To enable the cabinet to be supplied from the top, plates with cable entries are installed on top of the cabinet.

To ensure sufficient cooling, ventilated covers are installed in the upper and lower areas of the cabinet.

NOTE:

Also add the frame FN4xxE to cover gaps in the vertical front structure profiles.

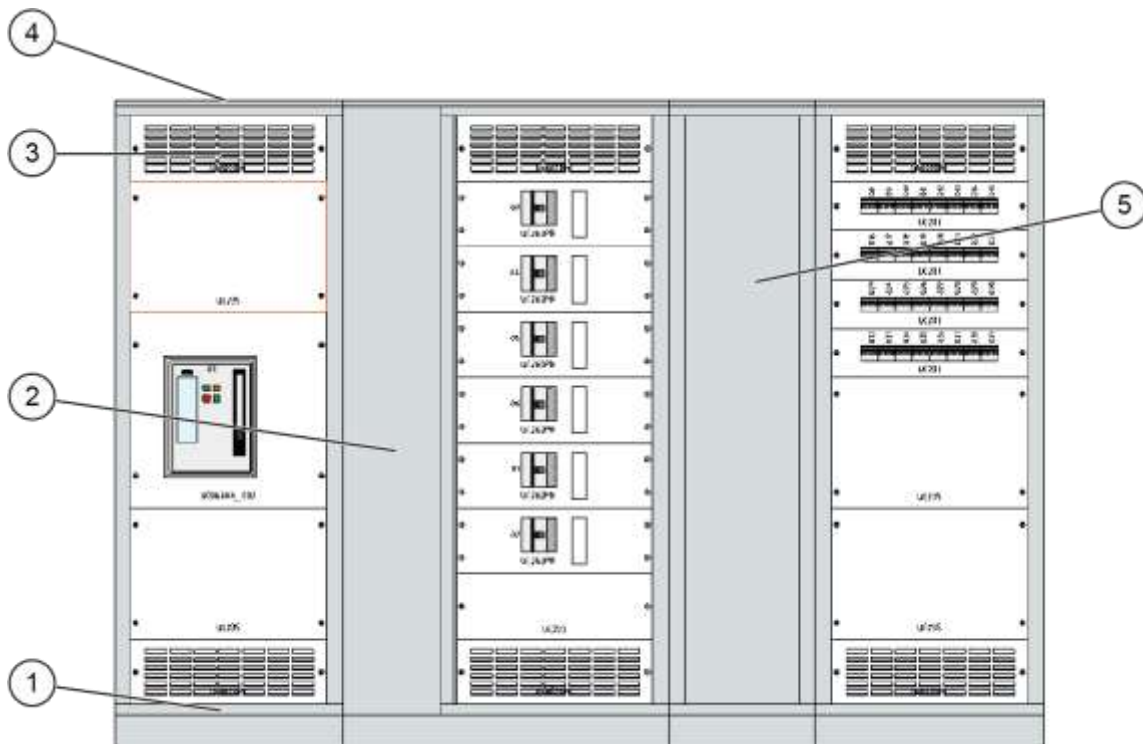

1	Plain Plate
2	Front / rear panel W200 / 300
3	Ventilated cover h = 200 mm
4	Top with cable entry plate
5	Front / rear panel or door W450

The back of the cabinet is built with ventilated rear panels (W700, W900, W1000) and one full rear panel (W450).

IP30 without front door and with bottom supply

To enable the cabinet to be supplied from the bottom, plates with cable entries are installed at the cabinet plinth.

To ensure sufficient cooling, ventilated covers are installed at the bottom and ventilated roof panels on top.

NOTE

Also add the frame FN4xxE to cover gaps in the vertical front structure profiles.

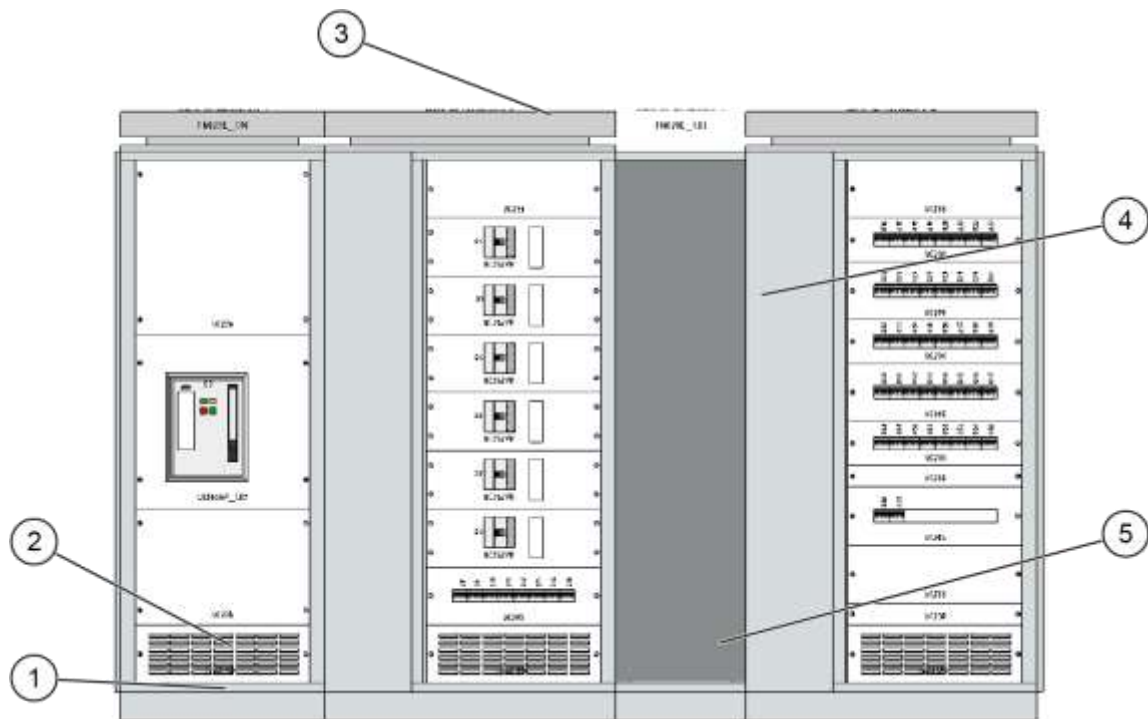

- | | |
|---|-------------------------------|
| 1 | Plate with cable entry plate |
| 2 | Ventilated cover h = 200 mm |
| 3 | Ventilated roof |
| 4 | Front / rear panel W200 / 300 |
| 5 | Door / rear panel W450 |

The back of the cabinet is built with ventilated rear panels (W700, W900, W1000) and one full rear panel (W450).

Reference table for roofs

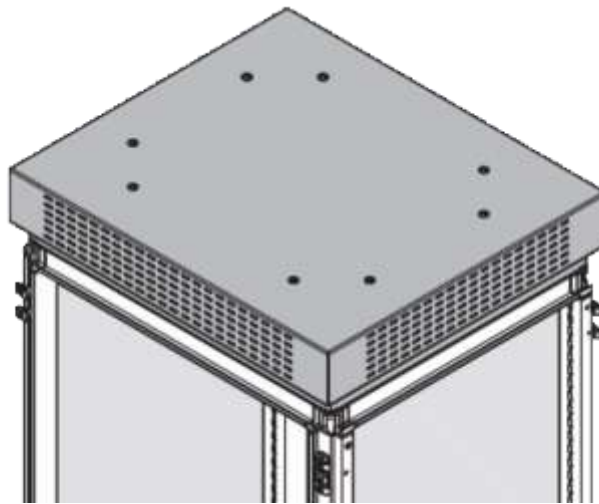

The roof is fitted to the cabinet structure using the 4 screws supplied.

Depth [mm]	Width [mm]			
	450	700	900	1000
400				
600				
800				
		FN7060R	FN9060R	FN10060R
		FN7080R	FN9080R	FN10080R

Reference table for louvred panels

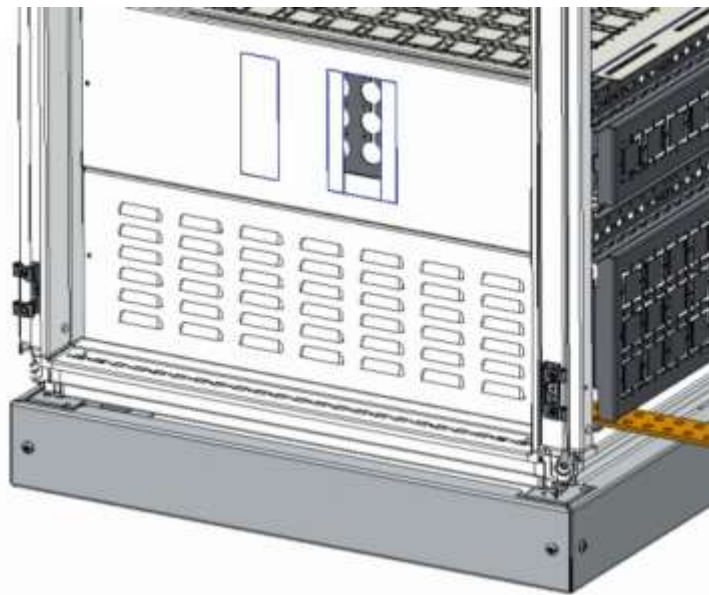

Depth [mm]	Width [mm]	
	600	800
100	UC6010PL	UC8010PL
200	UC6020PL	UC8020PL

To ensure air circulation in the enclosure for better heat dissipation, it is recommended to fit a louvred panel of 200 mm at the bottom of the cell, associated with a louvred top.

Reference tables for back panel with louvers



Depth [mm]	Width [mm]		
	700	900	1000
1900	FN276EWD *	FN296EWD *	FN246EWD *
2100	FN277EWD *	FN297EWD *	FN247EWD *

* W for RAL 9010 (white), G for RAL 7035 (light grey)

3.3.4 IP31 protection rating

General information

In the IP31 version, quadro evo cabinets are supplied with a door.

IP31 with front door and with top supply

To enable the cabinet to be supplied from the top, plates with cable entries are installed on top of the cabinet.

To ensure sufficient cooling, ventilated covers are installed in the upper and lower areas of the cabinet.

NOTE

Add plain or transparent doors on every single enclosure not equipped with a panel.

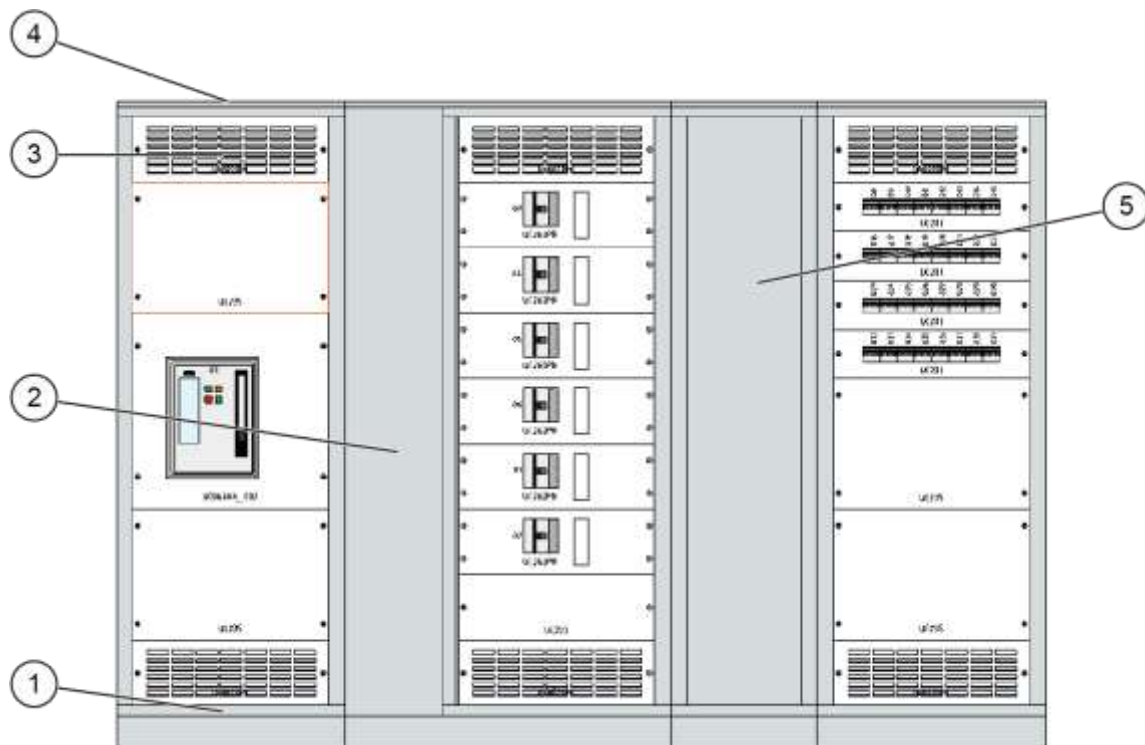

1	Plain Plate
2	Front / rear panel W200 / 300
3	Ventilated cover h = 200 mm
4	Top with cable entry plate
5	Front / rear panel or door W450

The back of the cabinet is built with ventilated rear panels (W700, W900, W1000) and one full rear panel (W450).

IP31 with front door and with bottom supply

To enable the cabinet to be supplied from the bottom, plates with cable entries are installed at the cabinet plinth.

To ensure sufficient cooling, ventilated covers are installed at the bottom and ventilated roof panels on top.

NOTE:

Add plain or transparent doors on every single enclosure not equipped with a panel.

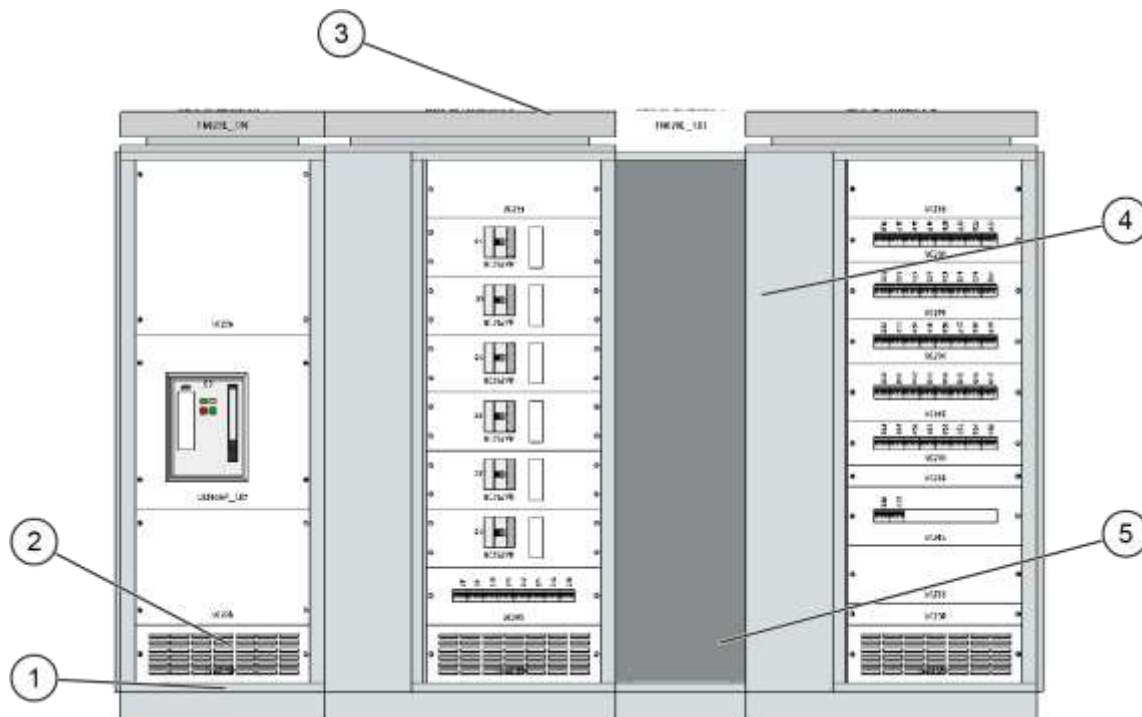

1	Plate with cable entry
2	Ventilated cover h = 200 mm
3	Ventilated roof
4	Front / rear panel W200 / 300
5	Door / rear panel W450

The back of the cabinet is built with ventilated rear panels (W700, W900, W1000) and one full rear panel (W450).

3.3.5 IP43 protection rating

General information



If the enclosure is equipped with modular doors, IP43 can be achieved.

Side panels and a door fitted with seals must be fixed to the cell structure. In the IP43 version, quadro evo cabinets have an impact resistance of IK10 and the locks are triangle inserts that can be changed for other inserts from the accessory options.

The pre - fitted hinges on either side of the uprights allow reversing the opening of the door.

IP43 configuration - modular door

Height [mm]	Vertical upright
1900	FN1900PD
2100	FN2100PD
Width [mm]	Top and bottom panel
700	FN60TBPW
900	FN80TBPW

External modular height	External cabinet width		Type	
	W700	W900		
H200	FN6020FDW ¹	FN8020FDW ¹	Fixed	
H200	FN6020MDW ¹	FN8020MDW ¹	DIN ²	
H200	FN6020PDW ¹	FN8020PDW ¹	Plain hinged	
H300	FN6030PDW ¹	FN8030PDW ¹	Plain hinged	
H400	FN6040PDW ¹	FN8040PDW ¹	Plain hinged	
H600	FN6060PDW ¹	FN8060PDW ¹	Plain hinged	
H600	UC766PDH	UC886PDH	ACB HW hinged ³	
H600	UC766PDT	UC786PDT	ACB HWT hinged ³	
H600		UC886PDT	ACB HWT 4000 A hinged ³	
H400	FN6040PGW ¹	FN8060PGW ¹	Glass hinged	
H600	FN6060PGW ¹	FN8060PGW ¹	Glass hinged	

¹ W for RAL 9010 (white), G for RAL 7035 (light grey)

² Limited to IP30

³ IP43 only in combination with "IP transparent cover"

Modular door and top supply or bottom supply

To fulfil the IP43 protection the devices need to be installed behind a full / full modular door. If the device is accessible without opening the door (e.g. modular door with ACB cut-out, DIN cut-out) the IP rate of this compartment is reduced to IP30.

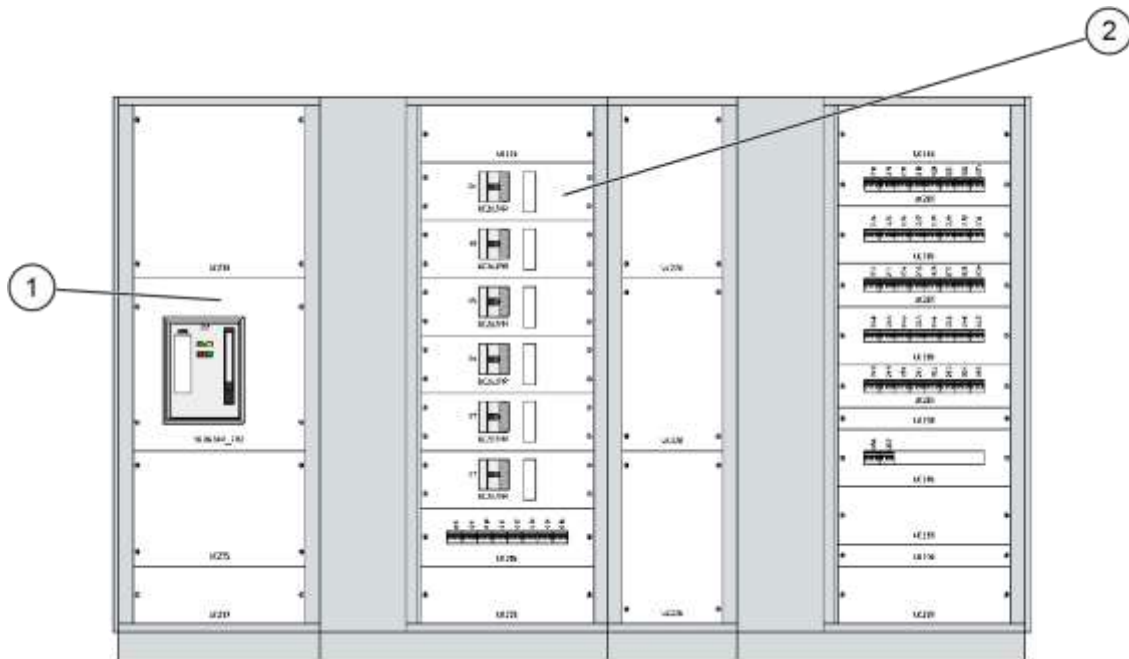

- 1 | Dedicated kit for modular doors
- 2 | Standard kit front cover + modular doors

The back of the cabinet is, without exception, built with full rear panels.

3.3.6 IP55 protection rating

General information



To achieve IP55 protection, side panels and a door with gasket must be fixed to the cell structure. In the IP55 version, quadro evo cabinets have an impact resistance of IK10 and the door handle is a pivoted lever with push button insert.

The pre-fitted hinges on either side of the uprights allow reversing the opening of the door.

IP55 with top supply

To enable the cabinet to be supplied from the top, plates with cable entries are installed on top of the cabinet.

NOTE

Add plain or transparent doors on every single enclosure not equipped with a panel. Cable compartment can be closed with plain full size panel or with a door.

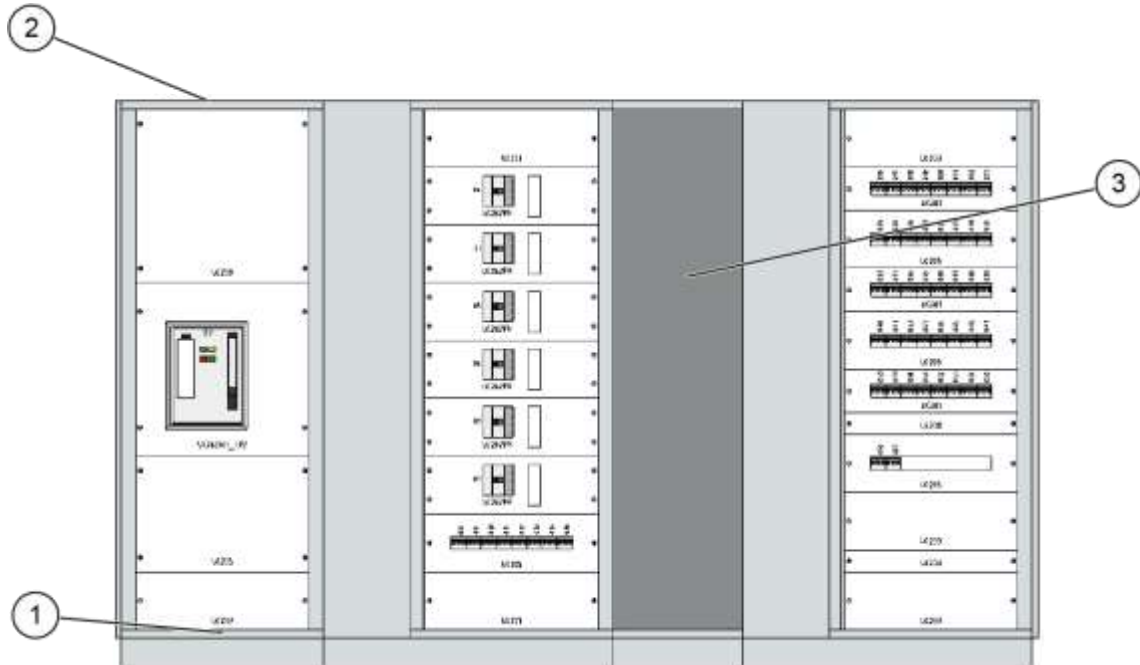

- | | |
|---|---------------------------------|
| 1 | Plain plate |
| 2 | Top with cable entry plate |
| 3 | Front / rear panel or door W450 |

The back of the cabinet is, without exception, built with full rear panels.

IP55 with bottom supply

To enable the cabinet to be supplied from the bottom, plates with cable entries are installed at the cabinet plinth.

NOTE

Add plain or transparent doors on every single enclosure not equipped with a panel. Cable compartment can be closed with plain full size panel or with a door.

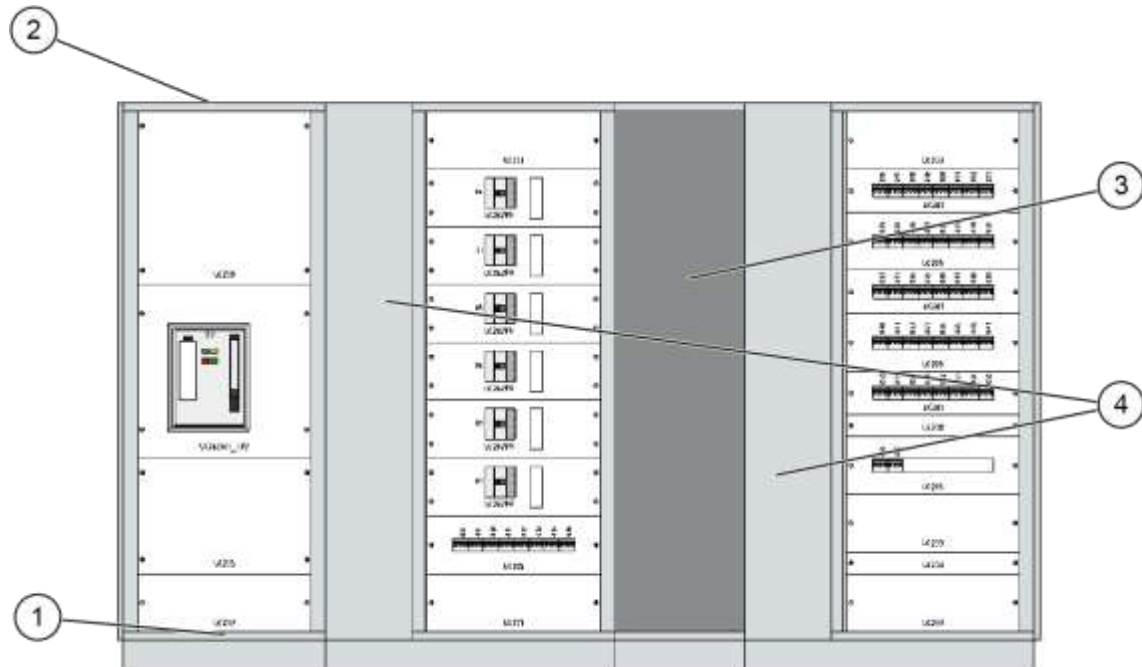

- | | |
|---|---------------------------------|
| 1 | Plate with cable entry plate |
| 2 | Plain plate |
| 3 | Front plain plate |
| 4 | Front / rear panel or door W450 |

The back of the cabinet is, without exception, built with full rear panels.

3.3.7 Lateral interconnection of cells

General information



Cabinets of the same depth and height can be interconnected widthwise using specially composed kits.

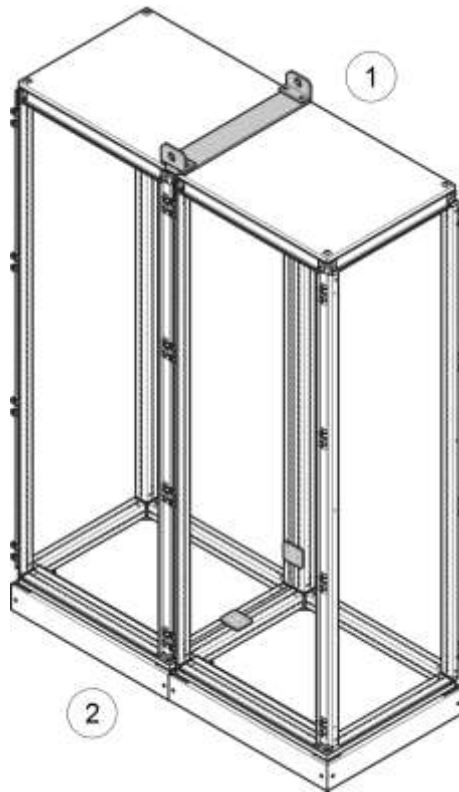

- 1 Back
- 2 Front

The kits are to be composed with the various references below:

Item	Cabinet depth [mm]	Sealing gasket	Connection plate	Lifting rings
		FN951	FN950	FZ760E
FN942E	400	x 1	x 1	x 1
FN973E	600	x 1	x 2	x 1
FN944E	800	x 1	x 2	x 1

Back-to-back and side-to-side interconnection of cells

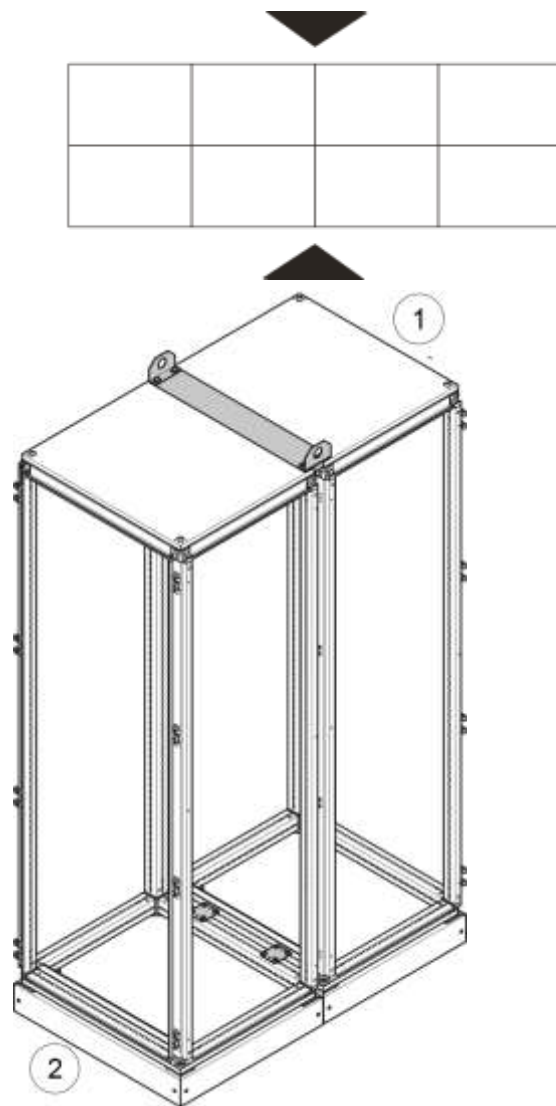

1 Back

2 Front

To combine cells (of the same width and height) depthwise, the various kits below should be used.

Item	Cabinet width [mm]	Sealing gas-ket	External connection plate	Connection plate	Lifting rings
		FN951	FN954E	FN950	FZ760E
FN946E	450	x 1	x 1	x 1	x 1
FN947E	700	x 1	x 1	x 1	x 1
FN948E	900	x 1	x 1	x 1	x 1
FN949E	1000	x 1	x 1	x 1	x 1

Corner mounting

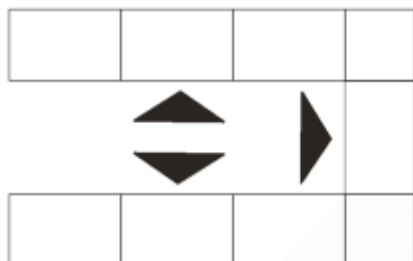

Enclosures of same depth can be arranged as a corner version.

Two back panels are required and no side panels and doors.

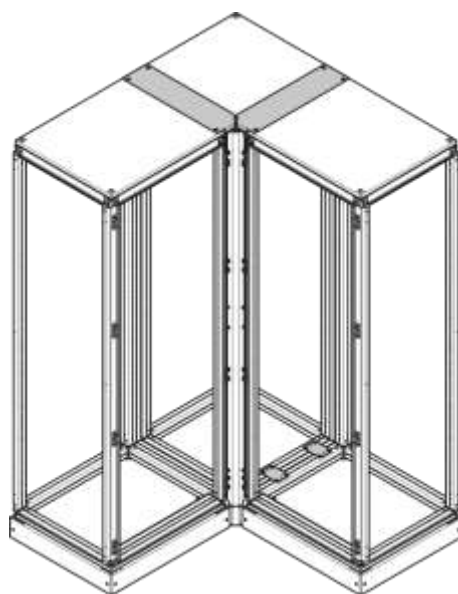

Item	Cabinet depth [mm]	Cabinet height [mm]	Add. plinth h100 *
FN004E	400	1900	FX438
FN005E	400	2100	FX438
FN006E	600	1900	FX450
FN007E	600	2100	FX450
FN008E	800	1900	FX458
FN009E	800	2100	FX458

* corner enclosure comes with a pre-equipped 100 mm plinth

3.3.8 Side and rear panels

General information

Panel fitting is made easier by a system for clipping and levelling of the structure, making assembly easier.

The rear panels can be replaced by doors as the cell uprights are pre-fitted with hinges.

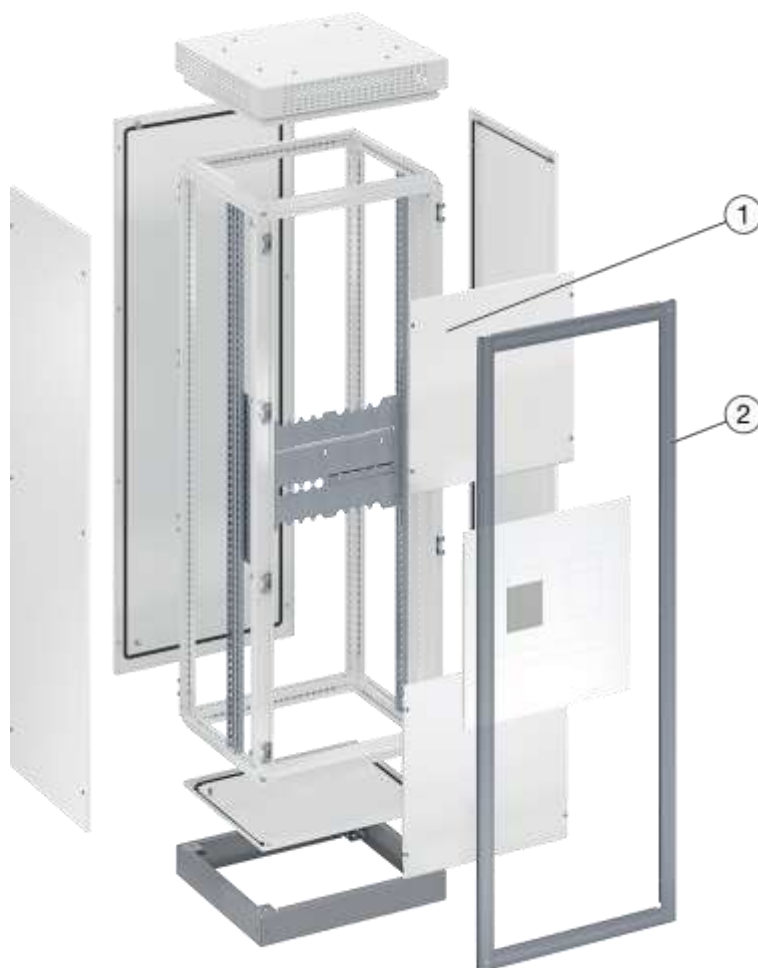

1 system kits front covers

2 IP30 design frame

Width [mm]	Height [mm]	Depth [mm]	Plain door	Glass door	Front- / rear panel	ventilated rear panel	Side panel	Inner door	Mounting plate
200	1900	x	x	x	FN266E		x	x	x
200	2100	x	x	x	FN267E		x	x	x
300	1900	x	x	x	FN206E		x	x	x
300	2100	x	x	x	FN207E		x	x	x
450	1900	x	FN546E	FN510E	FN216E		x	x	FN726E
450	2100	x	FN547E	FN511E	FN217E		x	x	FN727E
700	1900	x	FN506E	FN516E	FN276E	FN276EDW *	x	FN700E	FN736E
700	2100	x	FN507E	FN517E	FN277E	FN277EDW *	x	FN701E	FN737E
900	1900	x	FN526E	FN536E	FN296E	FN296EDW *	x	FN706E	FN746E
900	2100	x	FN527E	FN537E	FN297E	FN297EDW *	x	FN711E	FN747E
1000	1900	x	x	x	FN246E	FN246EDW *	x	x	x
1000	2100	x	x	x	FN247E	FN247EDW *	x	x	x

Width [mm]	Height [mm]	Depth [mm]	Plain door	Glass door	Front- / rear panel	ventilated rear panel	Side panel	Inner door	Mounting plate
x	1900	400	x	x	x		FN356E	x	x
x	2100	400	x	x	x		FN357E	x	x
	1900	600	x	x	x		FN366E	x	x
	2100	600	x	x	x		FN367E	x	x
	1900	800	x	x	x		FN376E	x	x
	2100	800	x	x	x		FN377E	x	x

* W for RAL 9010 (white), G for RAL 7035 (light grey)

3.3.9 Front covers

General information

Front covers are usually used to cover spare space in the assembly, or as spare parts, as the mounting kits for the devices are delivered together with the according front cover.

The DIN rail kit is an exception as it may be used for terminals - plain cover to be used - or for modular devices - modular cut - out cover needed.

Width [mm]	Height [mm]	Plain front cover	Modular cut-out front cover	Set back front cover (+46 mm)
450	50	UC221	x	x
450	75	UC220	x	x
450	150	UC222	UC200	x
450	200	UC223	x	x
450	300	UC224	x	x
450	400	UC225	x	x
450	600	UC226	x	x
450	800	UC227	x	x
700	50	UC231	x	x
700	75	UC230	x	x
700	100	UC239	x	x
700	150	UC232	UC201	x
700	200	UC233	UC205	x
700	300	UC234	x	UC291
700	400	UC235	x	UC292
700	600	UC236	x	UC293
700	800	UC237	x	x
900	50	UC241	x	x
900	75	UC240	x	x
900	100	UC249	x	x
900	150	UC242	UC203	x
900	200	UC243	UC207	x
900	300	UC244	x	UC296
900	400	UC245	x	UC297
900	600	UC246	x	UC298
900	800	UC247	x	x

To fix the front covers, make sure to install the front cover fixation uprights first.

UC1800F	Uprights for front covers fixation H1800
UC2000F	Uprights for front covers fixation H2000
UC1800FB	Uprights for fixation of internal system, including uprights for front covers fixation H1800
UC2000FB	Uprights for fixation of internal system, including uprights for front covers fixation H2000

3.3.10 Functional uprights

General information

The enclosure can be arranged in various ways to accommodate different products based on your needs and constraints.

The enclosure will be fitted with the functional uprights listed below so that you can use the full height of the enclosure for your switchgear layout. The equipment kits attach to the uprights.

Our equipment kits generally comprise a product mounting plate, a set of 4 brackets for attaching the plate to the uprights, and a cover panel.

Enclosure height [mm]	No space for busbars	Space for busbars in top section of enclosure
H = 1900	UC1800FB	UC1600FB
H = 2100	UC2000FB	UC1800FB

If you only require fittings for part of the enclosure height—one or two rows for example—we can supply partial functional uprights for the required height.

For equipment kit	Partial front functional upright
H = 200 mm	UC200F
H = 300 mm	UC300F
H = 400 mm	UC400F
H = 600 mm	UC600F
For height	Partial back functional upright
300 mm	UC300BU
400 mm	UC400BU
500 mm	UC500BU
600 mm	UC600BU
700 mm	UC700BU
800 mm	UC800BU
900 mm	UC900BU
1000 mm	UC1000BU



Illustrative configuration of functional uprights

Sections that are deep enough can accommodate double-front (e.g. modular) switchgear. You may use two sets of functional uprights in the same section, one for the front and one for the rear installation.



Double-front equipment

3.3.11 Fixation on horizontal uprights

General information

Bigger type of devices such as ACBs can be installed more cost effectively on separate horizontal profiles instead of full functions uprights.

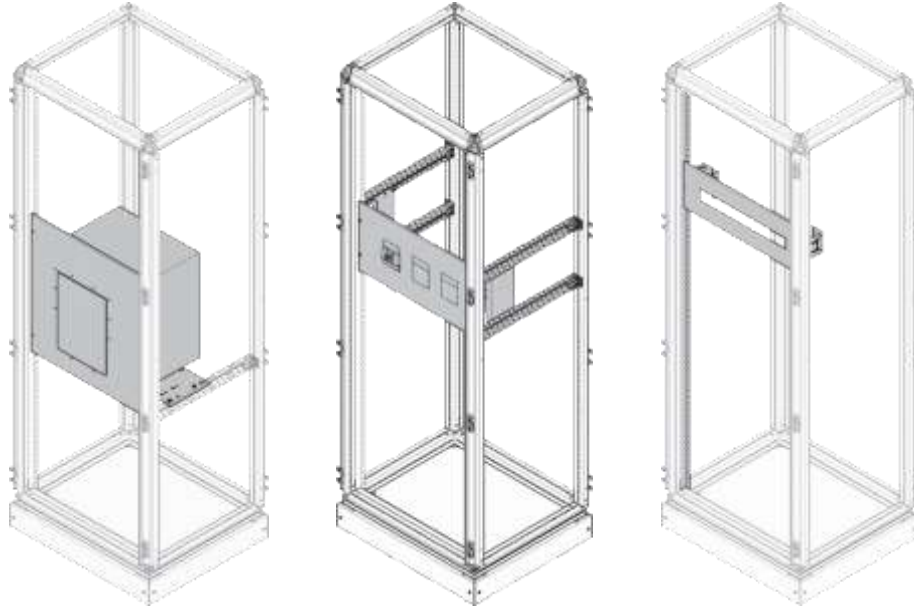

ACBs must be installed on horizontal uprights

MCCBs can be installed on horizontal uprights and on vertical uprights either

DIN rail kit is installed on the front uprights directly, without the need of horizontal or vertical uprights

Functional upright	For depth
UC300FU	400 mm
UC500FU	600 mm
UC700FU	800 mm

Additional profiles must be used to fix the front covers:

Front profile	For height
UC1800F	1900 mm
UC2000F	2100 mm

3.3.12 Fixing to the ground

Installing on floor

The location for the PSC must be prepared beforehand: the surface must be level as indicated below.

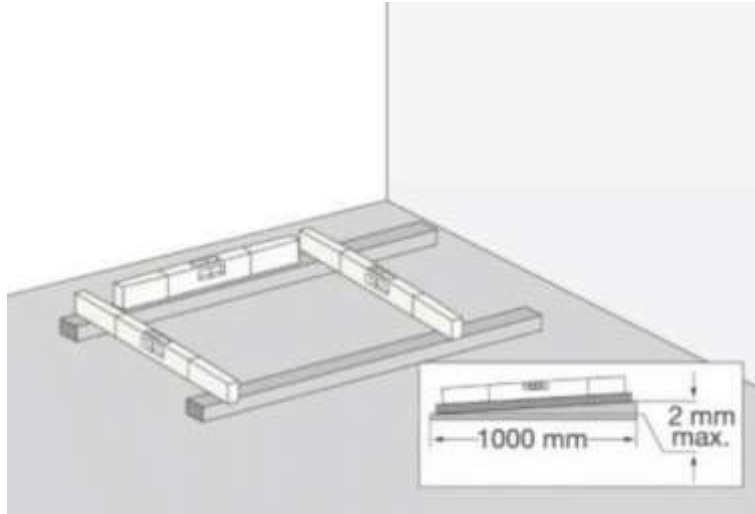

The plinths of the various cabinets must be fixed to the ground.

Fixing to the ground

Cabinets can be fixed to the ground with screws M12 (drilling $\varnothing = 14$ mm). To ensure stability, use the suitable quadro evo plinths and fix every plinth to the ground.

In the case of a single cabinet, the width and depth fixing distance between centres is equal to the width or depth of the enclosure minus 84 mm.

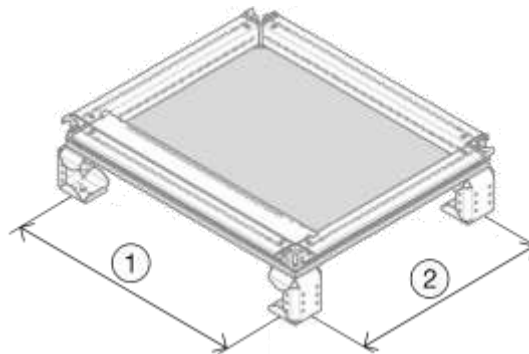

- | | |
|---|--------------------------------|
| 1 | Width of enclosure minus 84 mm |
| 2 | Depth of enclosure minus 84 mm |

For a set of adjacent cabinets:

- See the layout drawing below.

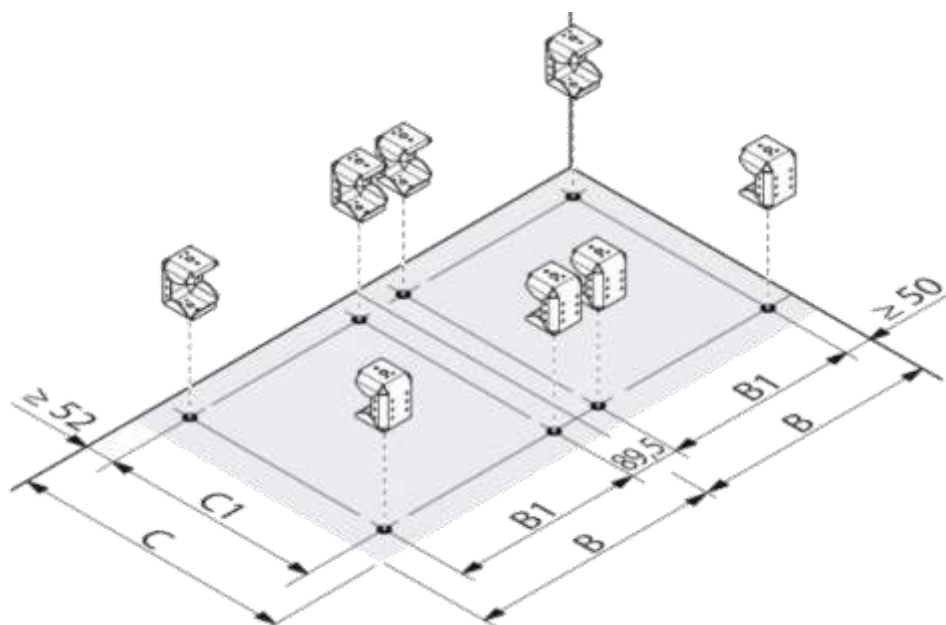

Width		Depth	
B outer dimension of enclosure (bottom line)	B1 center of the plinth	C outer dimension of enclosure (bottom line)	C1 center of the plinth
450	366	400	316
700	616	600	516
900	816	800	716
1000	916		

NOTE:

Floor and structure fixation are in the same position / distance

3.3.13 Permissible weights

Maximum weights

- The maximum weight of the internal system per single enclosure can be 600 kg. The load has to be distributed evenly.
- The maximum load that is allowed to be installed on a mounting plate is 500 kg (incl. the mounting plate).
- The maximum load permissible to install on the door is 50 kg.

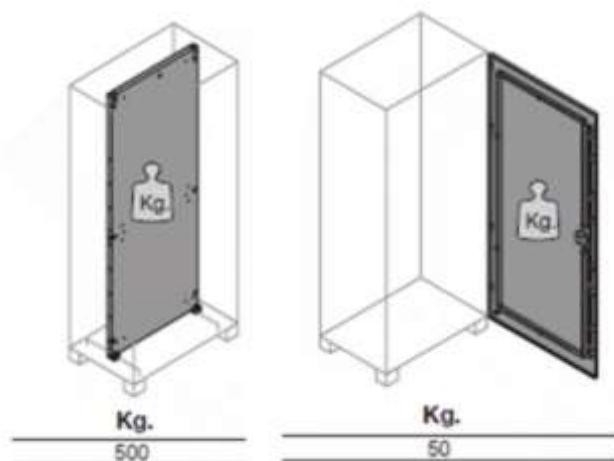
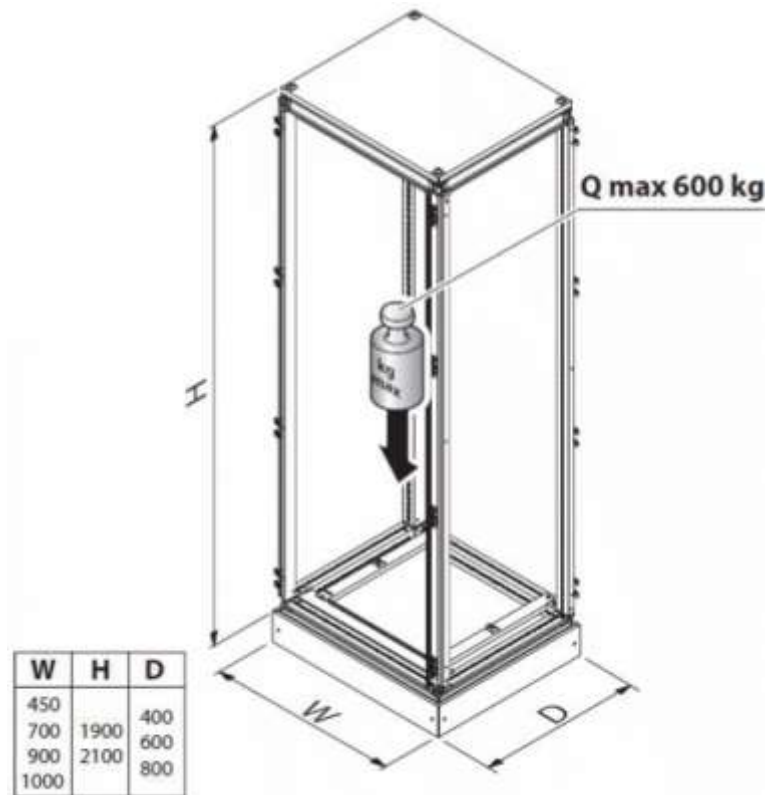

Busbar rules

To mount the copper / aluminium bus bar in the system of quadro evo, you should use the holders and support brackets provided.

Thickness of 5 / 10 mm copper and the aluminium profiles provided by Hager can be installed.

UC825BB

- Aluminium up to 1600 A
- Copper 1 x 5 or 2 x 5 mm

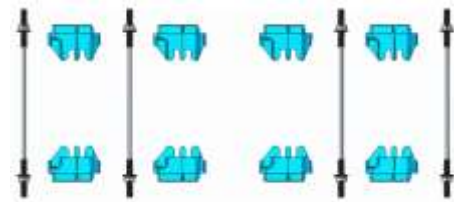

UC8210BB

- Copper 2 x 10 mm

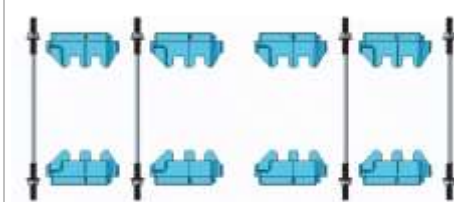

UC8110BB

- Copper 1 x 10 mm

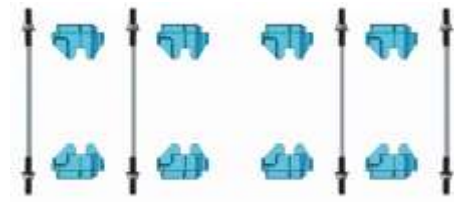

UC8310BB

- Copper 3 x 10 mm

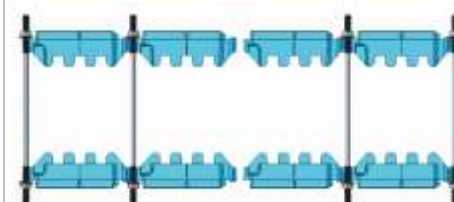

Busbar material	Interphase [mm]	busbar brackets	support on structure	flying supports
400 mm				
Aluminum profile	70	UC825BB	UC300BB	UC300BB
Copper 5 mm	70	UC825BB	UC300BB	UC300BB
Copper 10 mm	70	UC8110BB	UC300BB	UC300BB
600 mm				
Aluminum profile	70	UC825BB	UC500BB	UC300BB
Copper 5 mm	70	UC825BB	UC500BB	UC300BB
Copper 10 mm	70	UC8110BB	UC500BB	UC300BB
Aluminum profile	100	UC825BB	UC500BB	UC400BB
Copper 5 mm	100	UC825BB	UC500BB	UC400BB
Copper 10 mm	100	UC8110BB	UC500BB	UC400BB
Copper 10 mm	125	UC8210BB	UC500BB	UC500BB
800 mm				
Aluminum profile	70	UC825BB	UC700BB	UC300BB
Copper 5 mm	70	UC825BB	UC700BB	UC300BB
Copper 10 mm	70	UC8110BB	UC700BB	UC300BB
Aluminum profile	100	UC825BB	UC700BB	UC400BB
Copper 5 mm	100	UC825BB	UC700BB	UC400BB
Copper 10 mm	100	UC8110BB	UC700BB	UC400BB
Copper 10 mm	125	UC8210BB	UC700BB	UC500BB
Copper 10 mm	150	UC8310BB	UC700BB	UC600BB

When fixed on structure, dimension L must be of the same depth or width as the enclosure.

The flying support must be in line with the copper size, so the holders are fully fixed in line with the instructions.

The UC*BB support in the dimension of 800 mm is required to support the isolators fixation on the rear side 900 width enclosures.

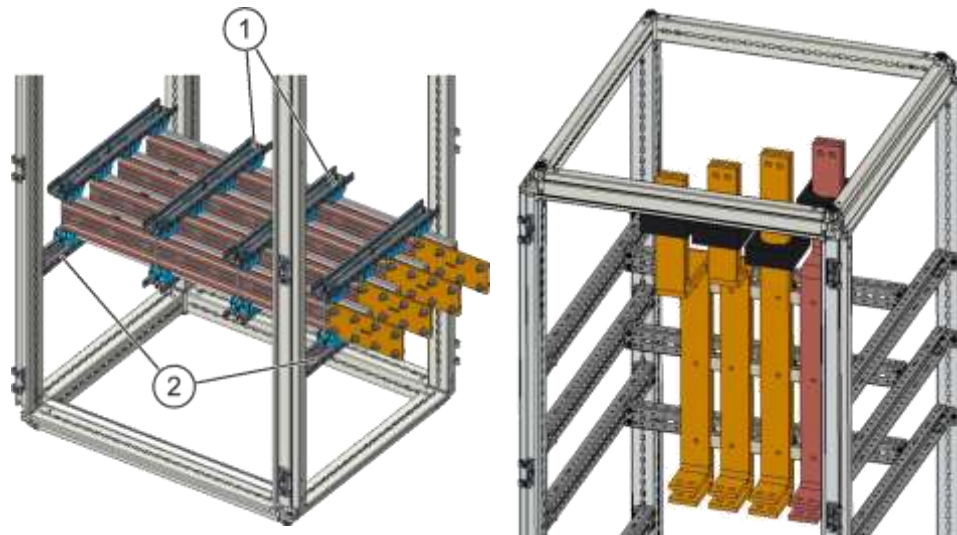

1 "flying" UC*00BB support in air

2 Support on structure

It is mandatory to use the special front cover in front of the main busbar in the 400 mm deep enclosure.



Code	W [mm]	H [mm]
UC3540FP	350	200
UC6040FP	600	200
UC8040FP	800	200
UC353040FP	350	300
UC603040FP	600	300
UC803040FP	800	300

At the top or in the bottom (symmetrical solution), only H200 is used and, in the middle, only H300 is used.



3.3.14 Lifting and handling

Lifting

Cabinets can be handled by the M12 lifting rings for weights not exceeding 1000 kg.

- To lift a single enclosure by crane, lifting rings FZ767 must be used.
- To lift an assembly of several enclosures, lifting brackets FZ760E must be used.

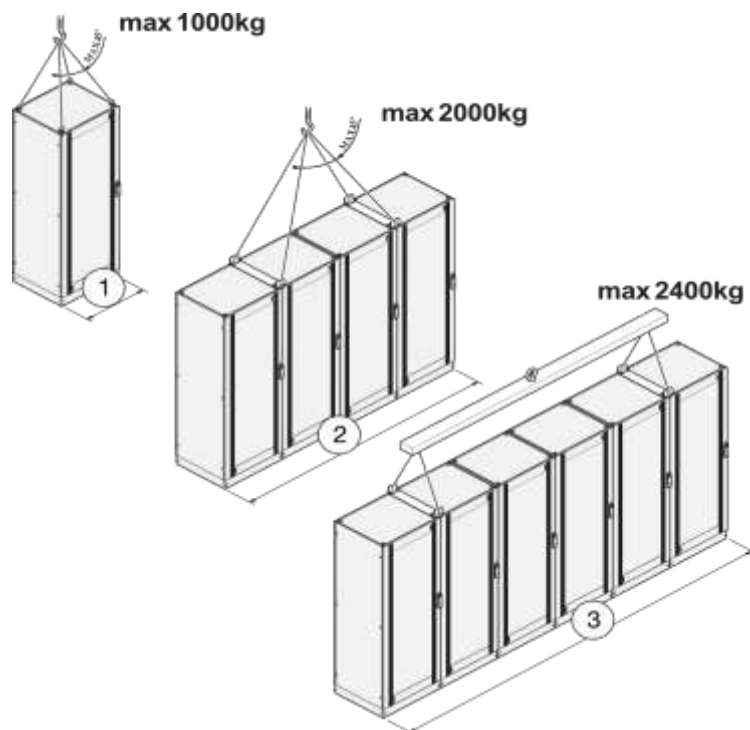

1	Width 400 max 1600 mm - max 1000 kg
2	Width 2400 max 3200 mm - max 1600 kg
3	Width 3200 max 4800 mm - max 2000 kg

Handling

Because of the large size of wired assemblies, particular vigilance is required while handling and appropriate mechanical means should be used (lifting, rolling).

Reduce mechanical shocks and vibrations to a minimum and be extremely careful that the assembly does not tip over.

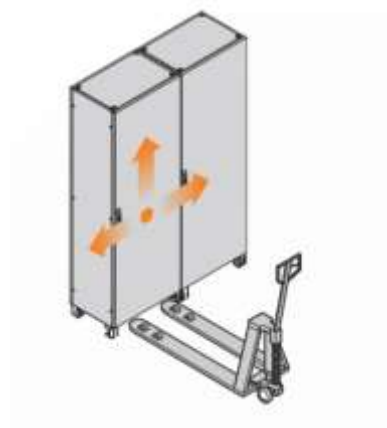

3.3.15 Accessory for enclosure

	Description	Code		Description	Code
	Plinth connection kit	FN430E		Rotary & sealing handle lock	FZ537
	Coupling kit	FN950		Triangular insert 8 mm	FL74Z
	Gasket	FN951		Double bit insert 3 mm	FL75Z
	Lifting brackets	FZ760E		Squared insert 8 x 8 mm	FL76Z
	Lifting rings	FZ767		Key insert nr.333E	FL98Z
	Rotary handle (with key)	FZ508		Insert squared 6 x 6 mm	FZ516
	Plastic pocket holder	FZ794		Lock with triangle insert, 7 mm, for modular doors	FZ450
	Steel pocket holder	FZ795D		Key insert nr.1242E	FZ506
	Door stopper	FN952		Key insert nr.405	FZ519
				Key insert nr.455	FZ520

3.4 Busbar and busbar supports

3.4.1 Copper manufacturing

Busbars

The combination of busbar support - busbars - switchgear must be able to support the high electrodynamic and thermal stresses of any short circuit. The intrinsic resistance of a switchboard to short circuit currents must be greater than the short circuit current calculated at the switchboard.

The busbars, whether main or secondary, convey and distribute the current and connect switchgear. The copper bar sections must be adequate for the current to be carried for a given heating to ensure the proper functioning of the switchboard. The arrangement and orientation of the copper bars and the positions of the equipment often make it necessary to work the copper. Carrying out this high-precision work requires know-how and following certain rules.

The copper bars used comply with standard EN 13601 and are of the electrolytic type Cu - ETP CW004A H065.

Bending

Bars can be bent cold, flat, on edge or curved to pattern (change of plane and 90° rotation). For flat bending, the internal radius of curvature must be 1 to 1.5 times the thickness of the copper bar.

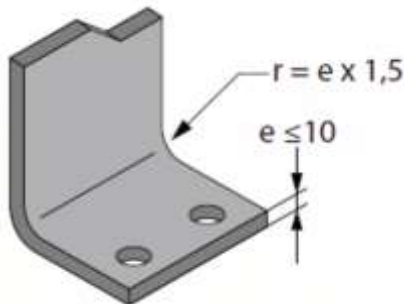

Surface condition and contact surface

Before assembling the various parts, remove any cutting or punching swarf and any traces of oil or grease.

The surface of a bar is never perfectly smooth or flat. When two surfaces are applied to each other under pressure, they are only in contact at certain points or over small surfaces. In practice, the actual contact surface is limited to areas where pressure is applied by the bolts.

Connections to busbars must be designed to achieve minimum contact resistance.

For busbars, there are several possibilities to consider

In case of extension or change in direction of a busbar at constant current and section, we recommend total overlap over the width of the bar to ensure optimum heat transfer.

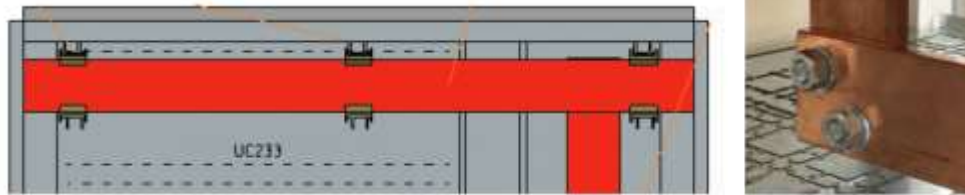

For the junction of a secondary distribution busbar from the main busbar (I_n secondary < I_n main), with a smaller current and section, the minimum overlapping distance to apply is 5 times the thickness of the secondary bar; beyond 6, the gain in efficacy is not significant.

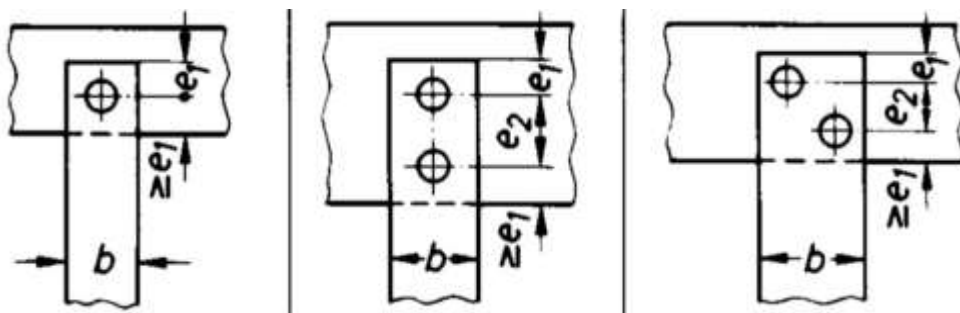

Example

For a bar of thickness 5 mm, the minimum overlap will be 25 mm. For a bar of thickness 10 mm, the minimum overlap will be 50 mm.

However, the number and size of mounting bolts must also be considered and this often results in exceeding this constraint.

Bolt quality

The quadro evo system has been certified to international standard IEC / EN IEC 61439-1 / -2 with bolts in zinc-coated white steel ZN8/C/Fe. Nuts and bolts of minimum quality 8.8 are obligatory.

The 1st digit corresponds to 1/10 of the value of the minimum tensile strength in N per mm², i.e. 800 N/mm² for class 8.

The product of the 1st and 2nd digits of the class gives the minimum elastic limit in N per mm², i.e. 640 N/mm².

Below are our assembly recommendations to follow between 2 copper pieces to ensure good electrical contact.

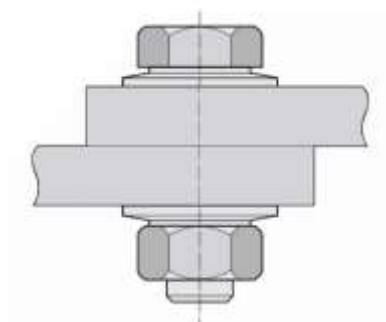

The length of the bolt must be calculated in view of the stacking of parts, washers and nut. The bolt must protrude by at least 2 threads after assembly.

We recommend the exclusive use of serrated conical washers CS in zinc-coated white steel ZN8/C/Fe in accordance with standard NFE 25-511, commonly called contact washers. These washers are to be placed on either side of the assembly.

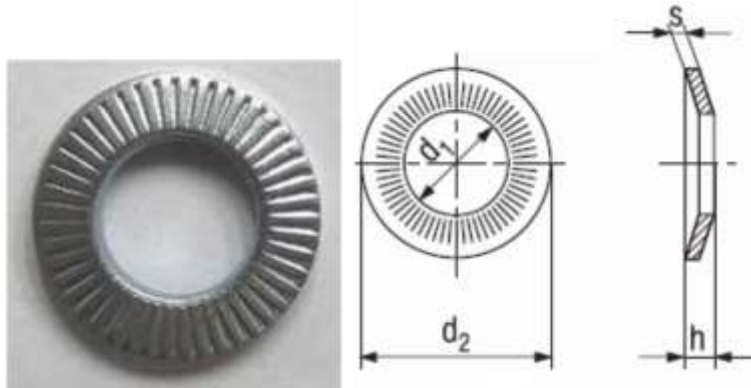

Contact washers are designed to achieve an assembly under elastic pre-stress, significantly reducing risks of accidental loosening. Contact washers are ideal for applications where there are vibrations and temperature variations.

The conical shape and striations make the bolt resistant to loosening while avoiding damage to the part.

Tightening torque

The tightening torque depends on the quality of the bolts and the tightening method (torque wrench, pneumatic driver, impact wrench etc.)

Below are our recommendations for tightening torques with large thread steel bolts, class 8.8. Tightening is exclusively by torque wrench without prior lubrication.

Table only valid for assembling copper parts with each other. For connection and tightening on the switchgear, refer to the relevant product info.

Assembly with contact washers on either side, and tightening torque not exceeding 75 % of the elastic limit of the bolt.

Nominal ISO bolt diameter	Pitch [mm]	Through hole diameter min. - max. [mm]	Recommended tightening torque [Nm]
M6	1	6.4 - 7	11
M8	1.25	8.4 - 9	22
M10	1.5	10.5 - 11	40
M12	1.75	13 - 13.5	70
M14*	2	15 - 15.5	110
M16	2	17 - 17.5	165
M18*	2.5	19 - 20	245
M20	2.5	21 - 22	340

* Very seldom used threads (to avoid if possible)

Colour marking

After tightening to the required torque, colour marking is to be applied to the nut and visible threads of the bolt to enable any loosening to be detected.

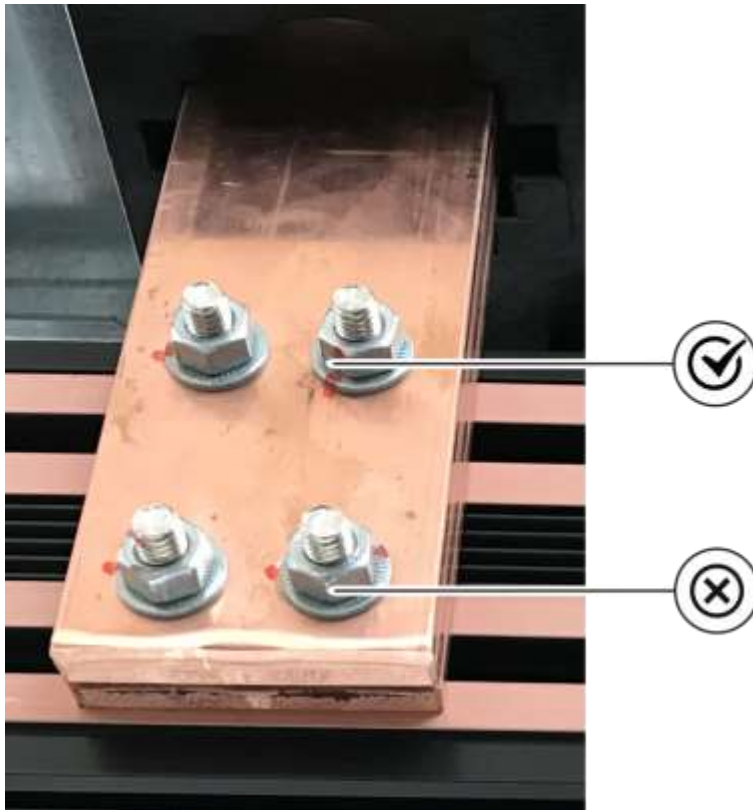

N.B.: Bolts are for one-time use and when dismantling an assembly that has previously been tightened to torque, all the nuts, bolts and washers are to be replaced.

For information, if bolts are reused the tightening force is reduced, resulting in a loss of 15 % on second tightening. After the sixth tightening, this results in a loss of over 50 %.

When putting together the various assemblies and joint pieces, it is essential to respect these 2 conditions:

- Use enough bolts to distribute and guarantee the pressure and contact surface between parts,
- Ensure that the permissible current per bolt is compatible with the application.

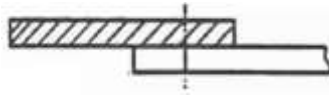
Maximum current per bolt**Connection between 2 busbars**

Nominal ISO bolt diameter	Maximum current per bolt [A]	Maximum current for 2 bolts [A]	Maximum current for 3 bolts [A]	Maximum current for 4 bolts [A]
M6	160	315	630	/
M8	250	630	800	1000
M10	500	1000	1600	/
M12	630	1250	2000	/

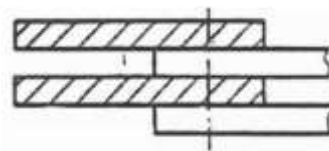
Connection between 4 busbars (2 busbars in // per conductor)

M6	250	630	1000	/
M8	500	1000	1250	1600
M10	800	1250	2000	2500
M12	1000	1600	2500	3200

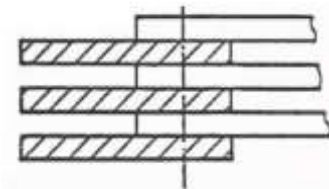

Connection between 6 or 8 busbars (3 or 4 busbars in // per conductor)

M10	1000	1600	2500	3200
M12	1250	2000	3200	4000

Aluminium busbars and Hammerhead screw

Nominal ISO bolt diameter	Pitch [mm]	Through hole diameter min. - max. [mm]	Recommended tightening torque [Nm]
M8	1.25	8.4 - 9	20

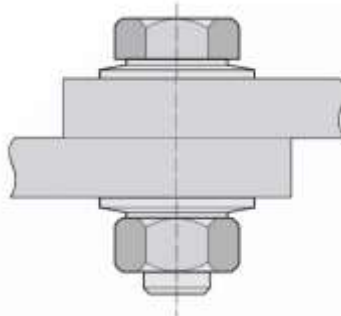
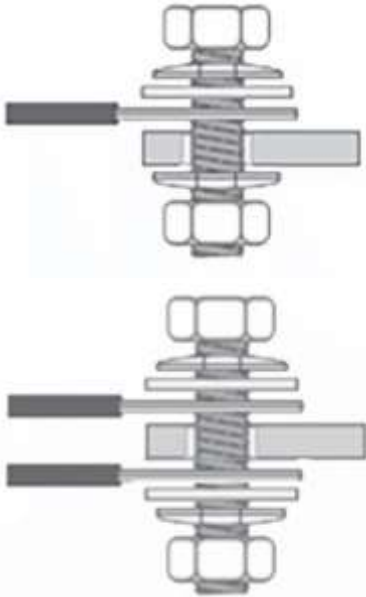
Assembly recommendations

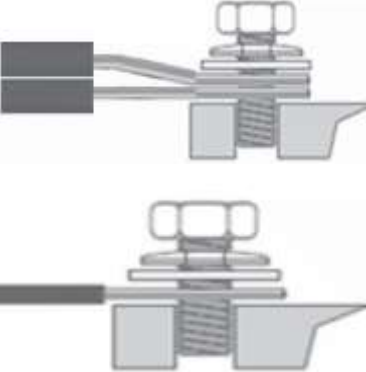
Connections		Assembly
<p>Busbar connection: copper / copper or Al / Al (not mixed copper / Al unless the Al is tinned)</p>		<ul style="list-style-type: none"> - Hexagonal bolt class 8.8 - Contact washer (CS) - Busbar - Busbar - Contact washer (CS) - Hexagonal nut class 8.8
<p>Flexible bar and copper bar</p>		<ul style="list-style-type: none"> - Hexagonal bolt class 8.8 - Contact washer (CS) - Flat washer ≥ 2 mm - Flexible busbar - Busbar - (Flexible busbar) - (Flat washer ≥ 2 mm) - Contact washer (CS) - Hexagonal nut class 8.8
<p>Flexible bar and aluminium profile</p>		<ul style="list-style-type: none"> - Hammerhead screw - Contact washer - Flat washer ≥ 2 mm - Flexible busbar - Aluminium busbar
<p>Flexible bar and equipment (connection on terminals of devices)</p>		<ul style="list-style-type: none"> - Bolt and washer supplied with the product - Flat washer ≥ 2 mm - Flexible busbar - Copper busbar - Nut

Connections

Copper bar and equipment
(connection on terminals of
devices)

**Assembly**

- Bolt and washer supplied with the product
- Busbar
- Nut

Characteristics of PVC-insulated flexible copper bars

- Operating voltage: 1000 VAC
- Operating temperature of -25 to +105 °C
- Insulation thickness: 1.65 mm minimum

Tools required

To cut the bar, use a tool that is intended for the right kind of material (aluminium / copper) and material thickness. The cutting tool has to be sharpened and must not deform nor warp the bar. Temperature rises should be minimized.

- Make sure the work area is clean.

 **WARNING**

Sawing generates swarfs that can be projected in the surrounding area.

Swarfs may be distributed by shoes and clothes

- It is recommended to do this working stage off-site the cabling workshop

Installation

Use a fastening that directs the saw perpendicular to the workpiece and that fixes the workpiece well in place.

A holder fitted with rollers is used to bring the bar opposite the cutting tool. A second holder with a ruler can be used to measure the desired length. The surface of the bar must not be deformed.

Cut the bar at 90° to the surface to achieve a constant alignment of holes by punching and to avoid an incorrect alignment of the bars during the installation procedure.

If you follow the above-mentioned points, it is easier to assemble the screw connections.

Bars must be cut by starting with the side of the copper contact track. After sawing, check that there are no flashes or alterations on the copper contact track.

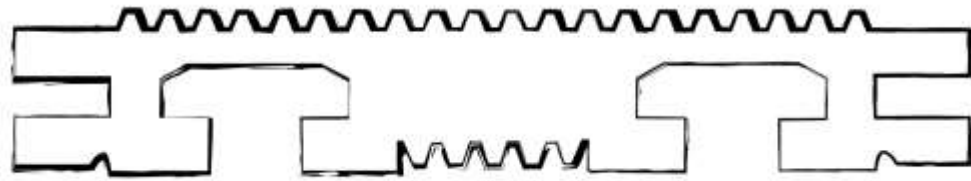
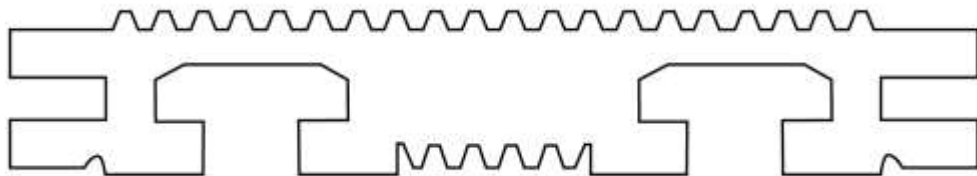
Remove flashes after cutting**Contact surfaces must be clean****Cleaning**

Deburr by removing any flashes that have arisen during the sawing work.

If the copper contact surfaces are oxidized, it is recommended to clean them using a micro-abrasive cloth.

Copper connection

The values for design verified configurations have been validated after tests on the quadro evo system at an ambient temperature of 35 °C.

For ease of installation and of compliance with IP XXB, we strongly recommend the use of insulated flexible busbars up to 630 A.

Advantages of the flexible busbar compared to cable:

- Better heat dissipation and better exchange surface
- Quick to install
- No lugs to crimp, less heating
- Requires less space than cables
- Greater mechanical strength in the event of short circuit
- Better appearance of the connected switchgear

Beyond 630 A, switchgear must be supplied via rigid copperbar for better mechanical strength of the assembly.

For design verified configurations, the copper connections design is strictly defined and must be manufactured following the drawings provided. The drawings can be downloaded from the design software HagerCAD, each configuration drawing consists of a layout for the assembly and detailed parts drawings to bend the copper accordingly.

- Observe the User Instruction(s) leaflets provided with the equipment.

Design verified configurations have been tested with plain unperforated copper bars. The dimensions of the copper is linked to the type of device, rated current, main busbar material and other criteria, details listed in the drawings. Some representative examples are given below.

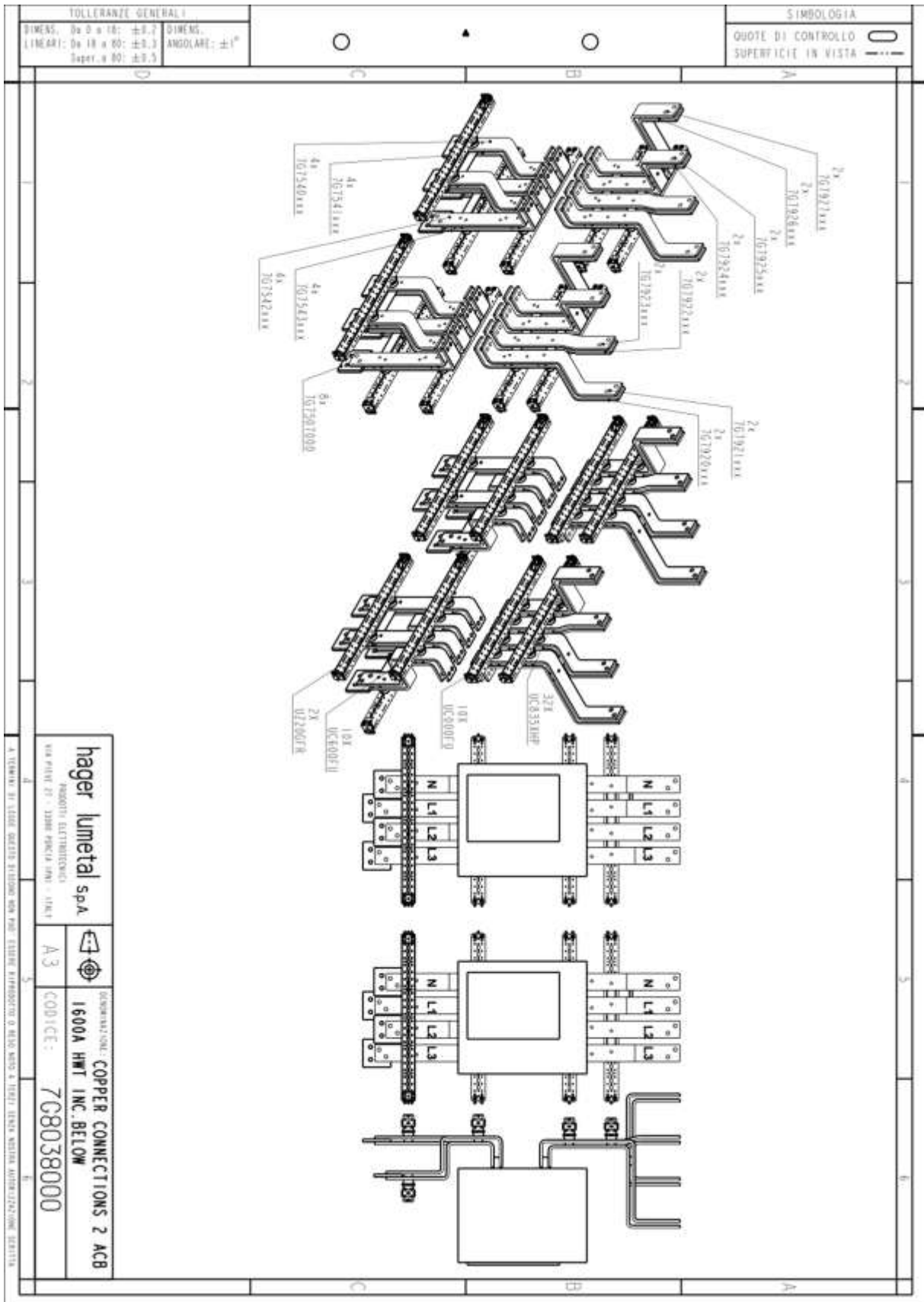

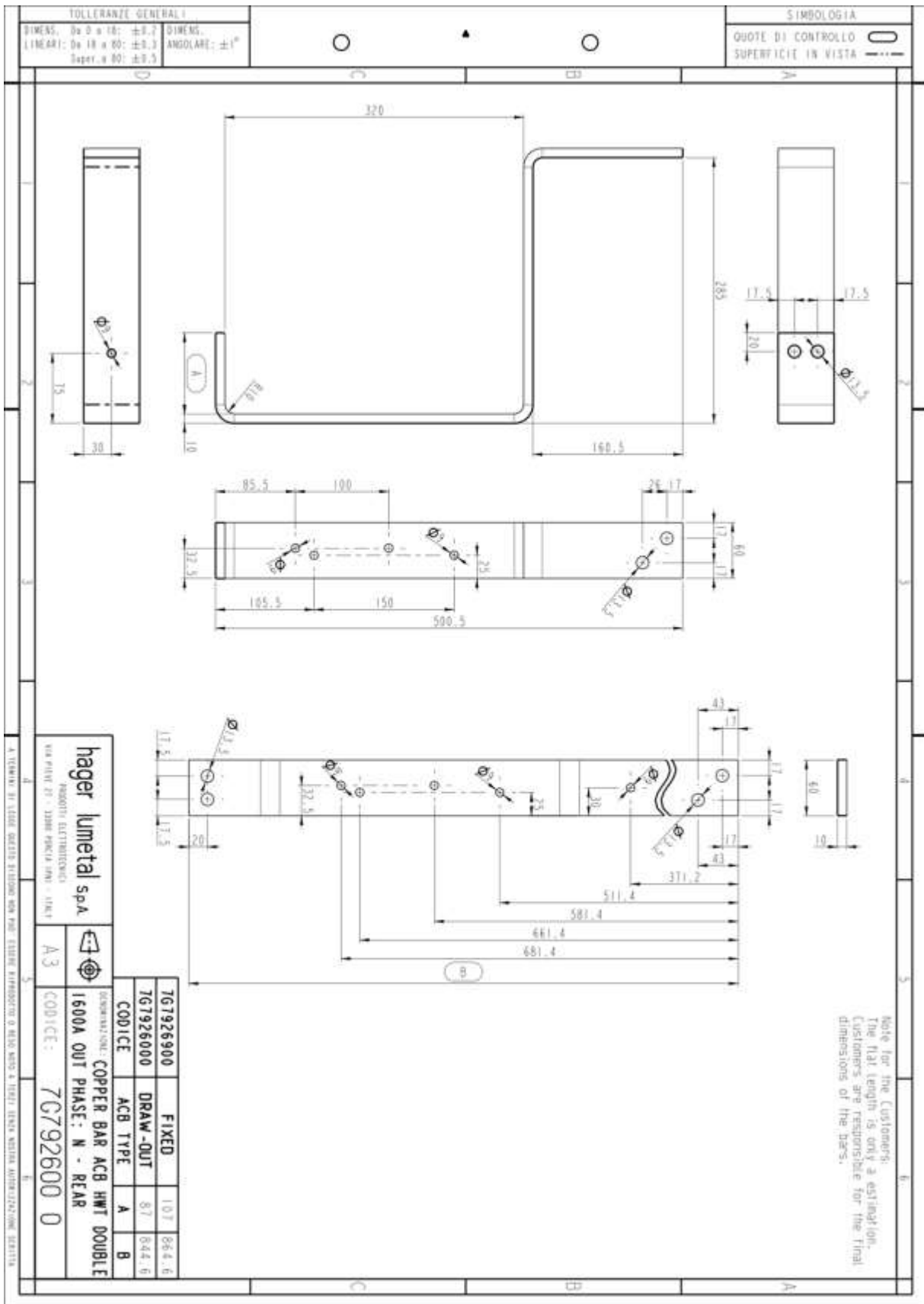

3.4.2 Mounting and fixation

Bus bar positioning

The main busbar can be installed horizontally, in the top, center or bottom of the enclosure.

The transfer busbar used in vertical orientation can be installed left, right hand side of the enclosure, and also in the rear of the cell.

The interphase distance and the position of the bars need to be installed according to the nominal current of the main busbar, short circuit current and available space in the enclosure.

Bars up to 1600 A can be installed in enclosures with depth of 400 and 600 mm. Busbars bigger than 1600 A need 800 mm deep enclosures, and interphase distance of 125 / 150 mm. Distance A should be considered from the front of the enclosure, to ensure the correct position for the connection links to fit exactly as provided on the drawings of hager.

Main Bus Bar positioning

Depth	Mat.	Distance "A" horizontal	Distance "A" vertical	Interphase distance "B"	Rated current
D400	Al	39	39	70	1600 A
	Cu 5 mm	40	35	70	1600 A
	Cu 10 mm	37.5	27.5	70	1600 A
D600	Al	39	39	70	1600 A
	Cu 5 mm	40	35	70	1600 A
	Cu 10 mm	37.5	27.5	70	1600 A
	Al	114	114	100	1600 A
	Cu 5 mm	112.5	107.5	100	1600 A
	Cu 10 mm	112.5	102.5	100	1600 A
D800	Al	39	39	70	1600 A
	Cu 5 mm	40	35	70	1600 A
	Cu 10 mm	37.5	27.5	70	1600 A
	Al	114	114	100	1600 A
	Cu 10 mm	112.5	102.5	100	1600 A
	Cu 10 mm	147.5	157.5	125	2000 A
	Cu 10 mm	147.5	157	120	2500 A - 4000 A

Cu Bars - Copper 1 x 10 mm

Legend for the following drawings:

- A Distance "A" horizontal / vertical
- B Interphase distance "B"

D400 horizontal / vertical

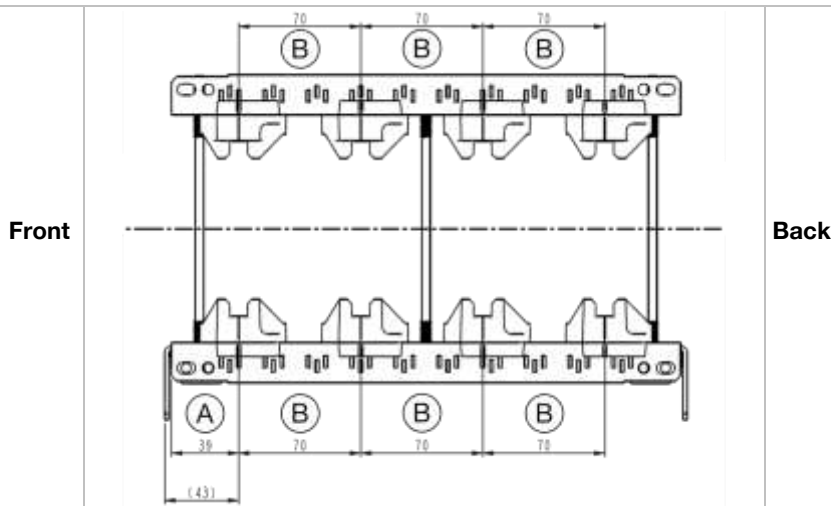

D600 / D800 horizontal

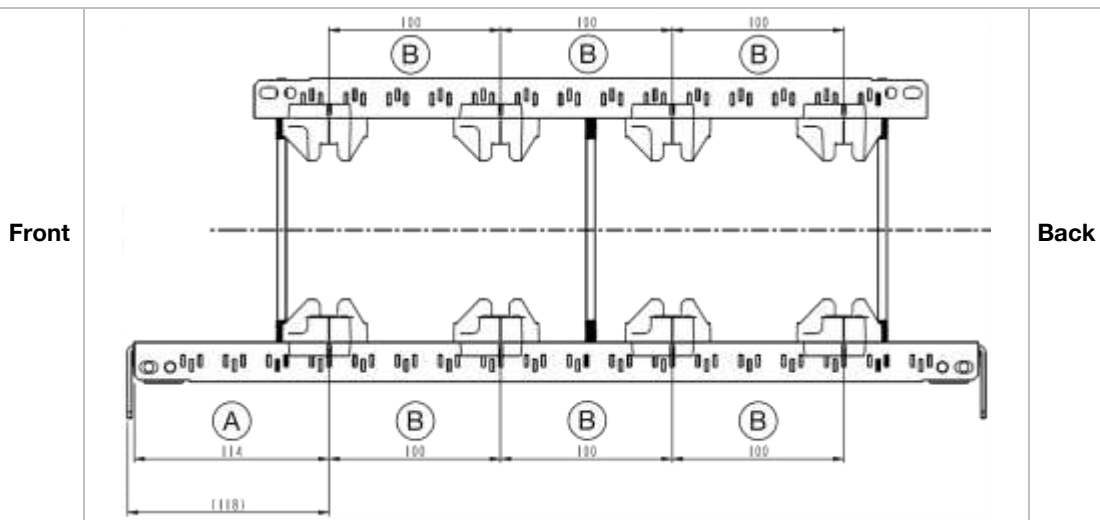

D800 vertical

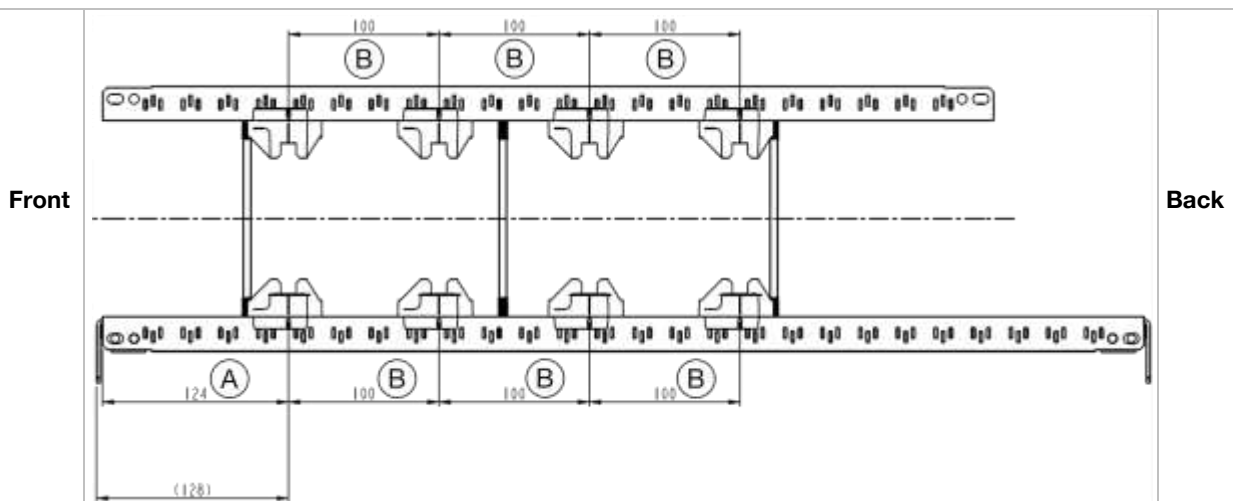

Cu Bars - Copper 2 x 10 mm

Legend for the following drawings:

- A | Distance "A" horizontal / vertical
- B | Interphase distance "B"

D800 horizontal

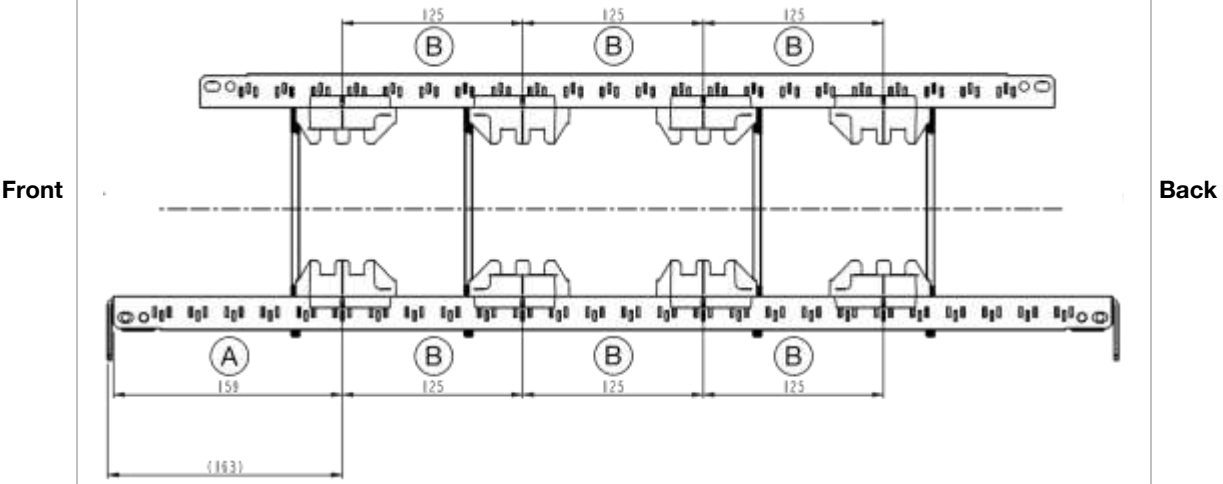

D800 vertical

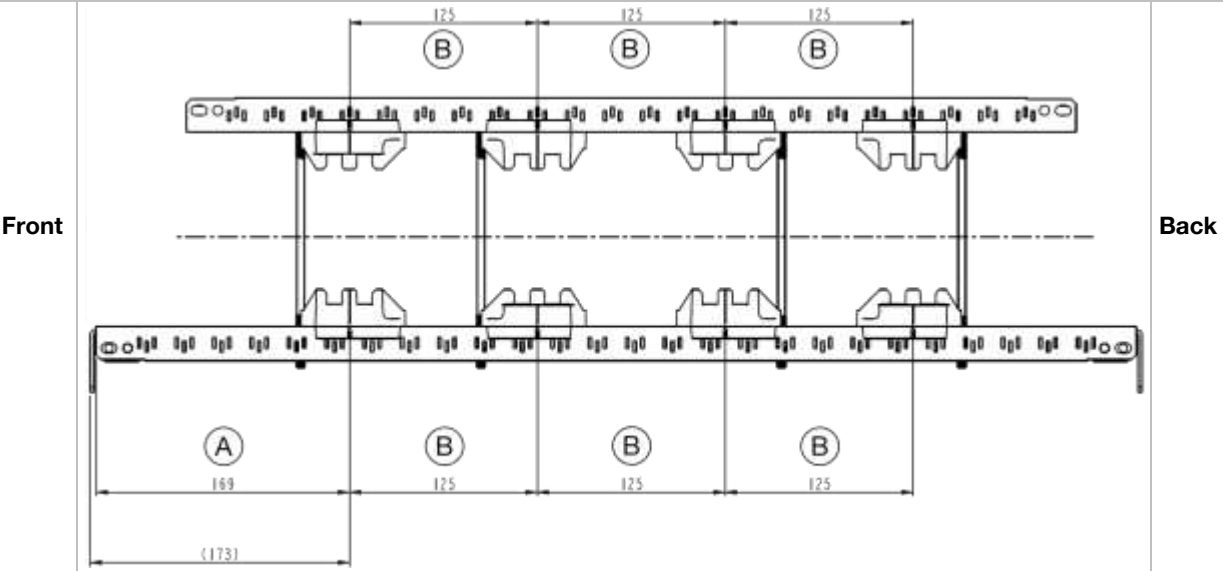

Cu Bars - Copper 3 x 10 mm

Legend for the following drawings:

- A | Distance "A" horizontal / vertical
- B | Interphase distance "B"

D800 horizontal

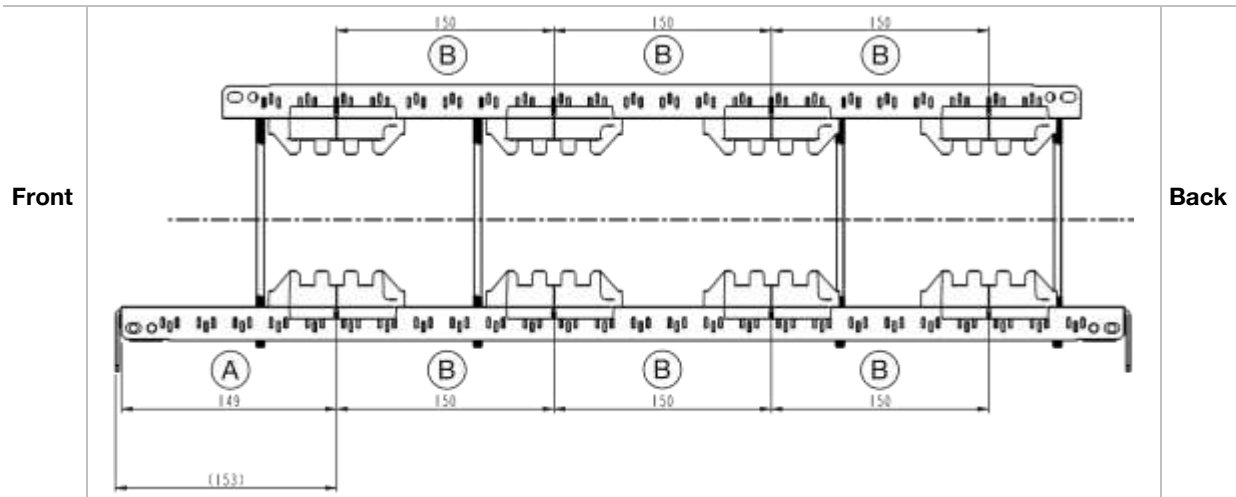

D800 vertical

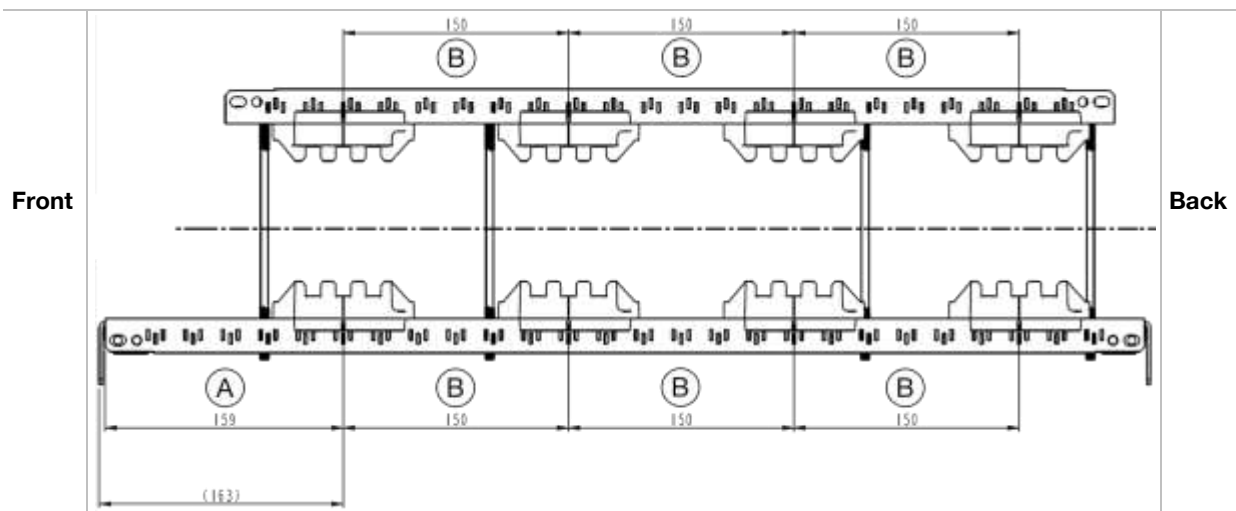

Al Bars - 2 x 5 mm

Legend for the following drawings:

- A Distance "A" horizontal / vertical
- B Interphase distance "B"

D400 horizontal / vertical

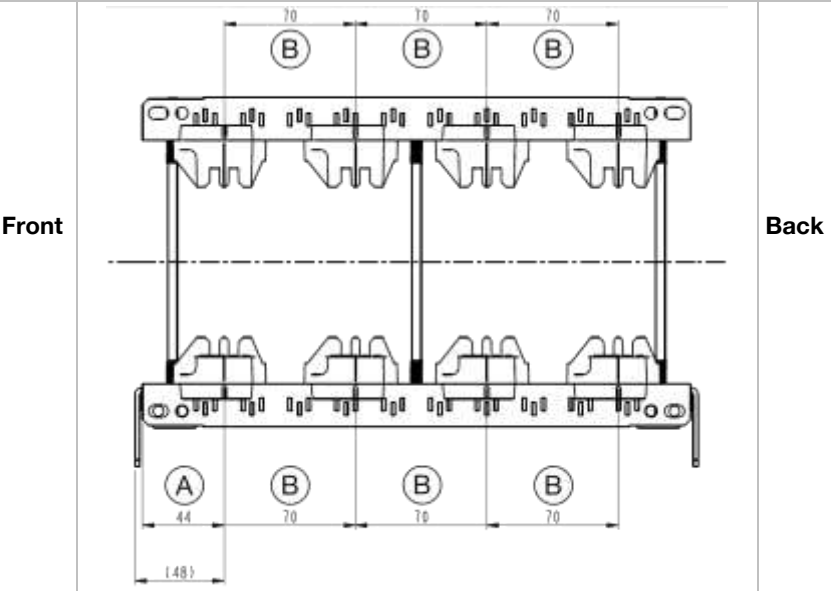

D600 / D800 horizontal

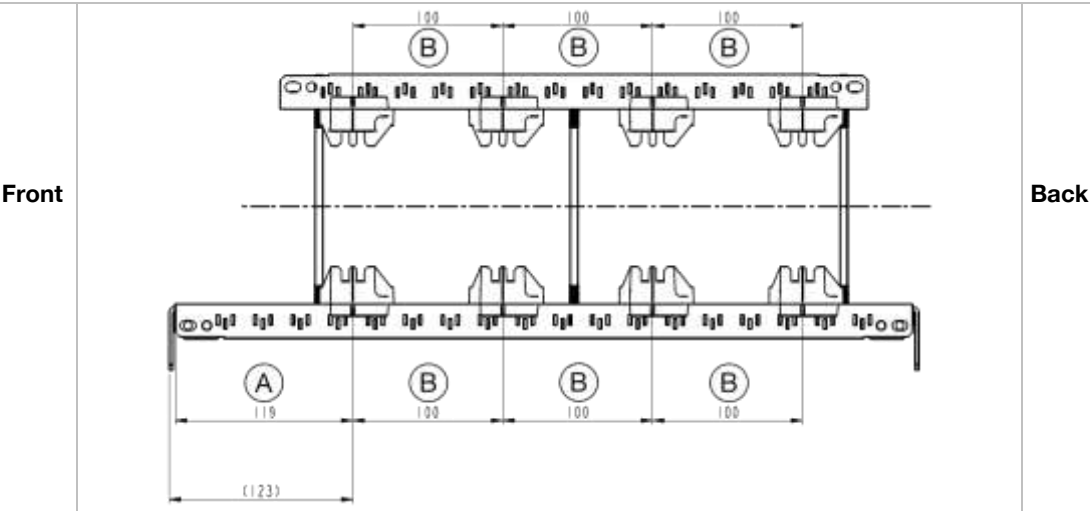

3.4.3 Copper busbar

Copper busbar selection for currents up to 1600 A - without holes

Installation			Up to 1600 A					
Permissible current*	IP30, IP31	[A]	500	630	800	1000	1250	1600
Enclosure depth: 400 / 600 / 800 mm	IP43, IP55	[A]	500	630	800	1000	1250	1600
Size of bars		[mm]	50 x 5	63 x 5	80 x 5	100 x 5	80 x 10	120 x 10
Number of bars per phase			1	1	1	1	1	1

*) for an ambient temperature of 35 °C around the switchboard

Copper busbar selection for currents up to 4000 A - without holes

Installation			Up to 4000 A			
Permissible current*	IP30, IP31	[A]	2000	2500	3200	4000
Enclosure depth: 800 mm	IP43, IP55	[A]	1700	2125	2720	3400
Size of bars		[mm]	80 x 10	100 x 10	100 x 10	120 x 10
Number of bars per phase			2	2	3	3

*) for an ambient temperature of 35 °C around the switchboard

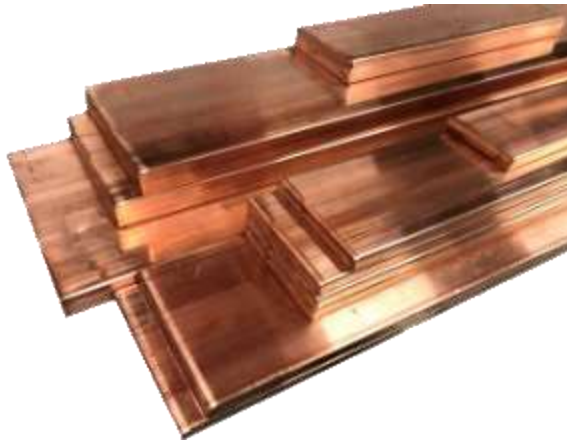

Busbar support placement

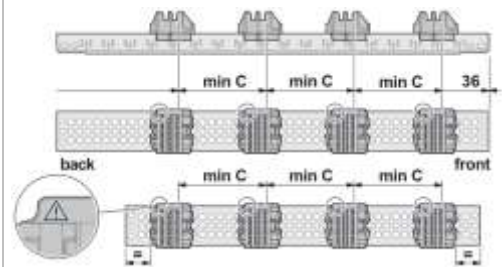
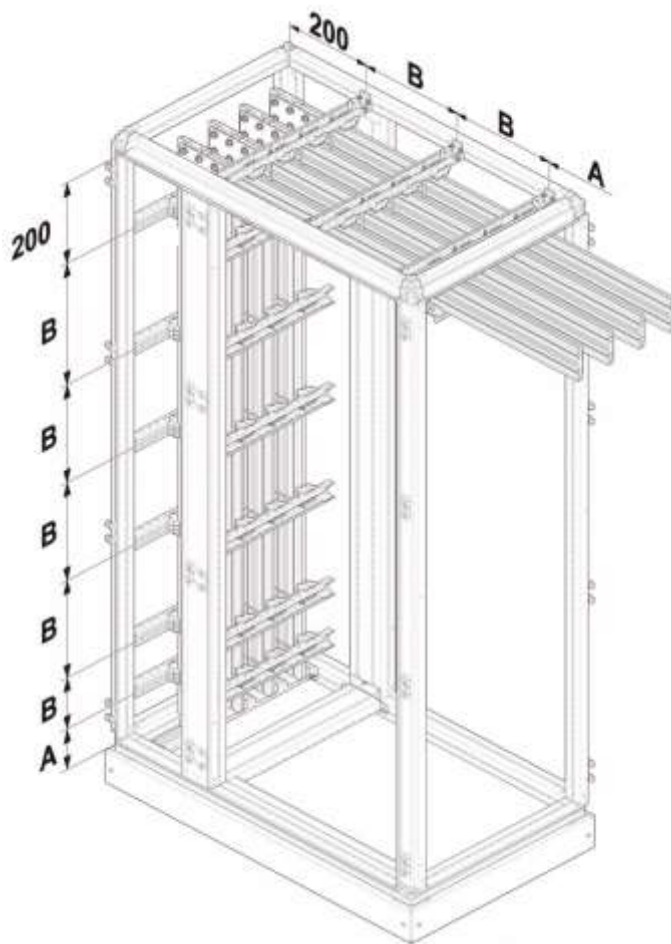

- A Distance between support and enclosure
- B Distance between supports
- C Phase-to-phase distance

NOTICE

Main busbar and secondary distribution busbar need to have the same phase-to-phase distance!

The busbars configurations presented in the next pages show a growing phase to phase distance with the depth of the enclosure.

It is possible to use the phase-to-phase distance of the depth 400 mm and mount the busbars in the enclosures of depth 600 mm and 800 mm in order to free up space at the rear of the cabinet.

3.4.3.1 Copper busbars, enclosure depth 400 mm - Technical data

Copper busbar enclosure depth 400 mm - 500 A

Material: copper Cross section: 50 x 5 x 1 Minimum enclosure depth: 400 mm							Material: copper Cross section: 50 x 5 x 1	
Main busbar							Secondary distribution busbar	
Current / A IP30	Current / A IP55	I _{cw} 1s / kA	I _{pk} / kA	Distance C phase to phase / mm	Distance A support and enclosure / mm	Distance B support to support / mm	Current / A IP30 & IP55	Distance B support to support / mm
500	500	40	84	70	100	225	500	225
500	500	35	73.5	70	100	225	500	225
500	500	30	63	70	100	225	500	225
500	500	25	52.5	70	125	275	500	275
500	500	15	30	70	225	475	500	475

Copper busbar enclosure depth 400 mm - 630 A

Material: copper Cross section: 63 x 5 x 1 Minimum enclosure depth: 400 mm							Material: copper Cross section: 63 x 5 x 1	Material: copper Cross section: 50 x 5 x 1		
Main busbar							Secondary distribution busbar			
Current / A IP30	Current / A IP55	I _{cw} 1s / kA	I _{pk} / kA	Distance C phase to phase / mm	Distance A support and enclosure / mm	Distance B support to support / mm	Current / A IP30 & IP55	Distance B support to support / mm	Current / A IP30 & IP55	Distance B support to support / mm
630	630	52	114.4	70	100	225	630	225	x	x
630	630	40	84	70	100	225	630	225	500	225
630	630	35	73.5	70	100	225	630	225	500	225
630	630	30	63	70	125	250	630	250	500	225
630	630	25	52.5	70	150	300	630	300	500	275
630	630	15	30	70	250	525	630	525	500	475

Copper busbar enclosure depth 400 mm - 800 A

Material: copper Cross section: 80 x 5 x 1 Minimum enclosure depth: 400 mm							Material: copper Cross section: 80 x 5 x 1	Material: copper Cross section: 63 x 5 x 1	Material: copper Cross section: 50 x 5 x 1			
Main busbar							Secondary distribution busbar					
Current / A IP30	Current / A IP55	I _{cw} 1s / kA	I _{pk} / kA	Distance C phase to phase / mm	Distance A support and enclosure / mm	Distance B support to support / mm	Current / A IP30 & IP55	Distance B support to support / mm	Current / A IP30 & IP55	Distance B support to support / mm	Current / A IP30 & IP55	Distance B support to support / mm
800	800	65	143	70	100	225	800	225	x	x	x	x
800	800	52	114.4	70	100	225	800	225	630	225	x	x
800	800	40	84	70	100	225	800	225	630	225	500	225
800	800	35	73.5	70	125	250	800	250	630	225	500	225
800	800	30	63	70	150	300	800	300	630	250	500	225
800	800	25	52.5	70	175	350	800	350	630	300	500	275
800	800	15	30	70	300	600	800	600	630	525	500	475

Copper busbar enclosure depth 400 mm - 800 A

Material: copper Cross section: 80 x 5 x 1 Minimum enclosure depth: 400 mm							Material: aluminium Cross section: 50 x 18.5 x 1	
Main busbar							Secondary distribution busbar	
Current / A IP30	Current / A IP55	I _{cw} 1s / kA	I _{pk} / kA	Distance C phase to phase / mm	Distance A support and enclosure / mm	Distance B support to support / mm	Current / A IP30 & IP55	Distance B support to support / mm
800	800	65	143	70	100	225	x	x
800	800	52	114.4	70	100	225	x	x
800	800	40	84	70	100	225	800	300
800	800	35	73.5	70	125	250	800	300
800	800	30	63	70	150	300	800	300
800	800	25	52.5	70	175	350	800	300
800	800	15	30	70	300	600	800	300

Copper busbar enclosure depth 400 mm - 1000 A

Material: copper Cross section: 100 x 5 x 1 Minimum enclosure depth: 400 mm							Material: copper Cross section: 100 x 5 x 1	Material: copper Cross section: 80 x 5 x 1	Material: copper Cross section: 63 x 5 x 1			
Main busbar							Secondary distribution busbar					
Current / A IP30	Current / A IP55	Icw 1s / kA	Ipk / kA	Distance C phase to phase / mm	Distance A support and enclosure / mm	Distance B support to support / mm	Current / A IP30 & IP55	Distance B support to support / mm	Current / A IP30 & IP55	Distance B support to support / mm	Current / A IP30 & IP55	Distance B support to support / mm
1000	1000	65	143	70	100	225	1000	225	800	225	x	x
1000	1000	52	114.4	70	100	225	1000	225	800	225	630	225
1000	1000	40	84	70	125	250	1000	250	800	225	630	225
1000	1000	35	73.5	70	125	275	1000	275	800	250	630	225
1000	1000	30	63	70	150	325	1000	325	800	300	630	250
1000	1000	25	52.5	70	200	400	1000	400	800	350	630	300
1000	1000	15	30	70	325	675	1000	675	800	600	630	525

Copper busbar enclosure depth 400 mm - 1000 A

Material: copper Cross section: 100 x 5 x 1 Minimum enclosure depth: 400 mm							Material: copper Cross section: 50 x 5 x 1	
Main busbar							Secondary distribution busbar	
Current / A IP30	Current / A IP55	Icw 1s / kA	Ipk / kA	Distance C phase to phase / mm	Distance A support and enclosure / mm	Distance B support to support / mm	Current / A IP30 & IP55	Distance B support to support / mm
1000	1000	65	143	70	100	225	x	x
1000	1000	52	114.4	70	100	225	x	x
1000	1000	40	84	70	125	250	500	225
1000	1000	35	73.5	70	125	275	500	225
1000	1000	30	63	70	150	325	500	225
1000	1000	25	52.5	70	200	400	500	275
1000	1000	15	30	70	325	675	500	475

Copper busbar enclosure depth 400 mm - 1000 A

Material: copper Cross section: 100 x 5 x 1 Minimum enclosure depth: 400 mm							Material: aluminium Cross section: 50 x 18.5 x 1	
Main busbar							Secondary distribution busbar	
Current / A IP30	Current / A IP55	Icw 1s / kA	Ipk / kA	Distance C phase to phase / mm	Distance A support and enclosure / mm	Distance B support to support / mm	Current / A IP30 & IP55	Distance B support to support / mm
1000	1000	65	143	70	100	225	x	x
1000	1000	52	114.4	70	100	225	x	x
1000	1000	40	84	70	125	250	800	300
1000	1000	35	73.5	70	125	275	800	300
1000	1000	30	63	70	150	325	800	300
1000	1000	25	52.5	70	200	400	800	300
1000	1000	15	30	70	325	675	800	300

Copper busbar enclosure depth 400 mm - 1250 A

Material: copper
 Cross section: 80 x 10 x 1
 Minimum enclosure depth: 400 mm

Material:
 copper
 Cross section:
 80 x 10 x 1

Material:
 copper
 Cross section:
 100 x 5 x 1

Material:
 copper
 Cross section:
 80 x 5 x 1

Material:
 copper
 Cross section:
 63 x 5 x 1

Main busbar							Secondary distribution busbar							
Current / A IP30	Current / A IP55	Icw 1s / kA	Ipk / kA	Distance C phase to phase / mm	Distance A support and enclosure / mm	Distance B support to support / mm	Current / A IP30 & IP55	Distance B support to support / mm	Current / A IP30 & IP55	Distance B support to support / mm	Current / A IP30 & IP55	Distance B support to support / mm	Current / A IP30 & IP55	Distance B support to support / mm
1250	1250	85	187	70	100	225	1250	225	x	x	x	x	x	x
1250	1250	75	165	70	100	225	1250	225	x	x	x	x	x	x
1250	1250	70	154	70	125	250	1250	250	x	x	x	x	x	x
1250	1250	65	143	70	125	275	1250	275	1000	225	800	225	x	x
1250	1250	52	114.4	70	175	350	1250	350	1000	225	800	225	630	225
1250	1250	40	84	70	225	450	1250	450	1000	250	800	225	630	225
1250	1250	35	73.5	70	250	500	1250	500	1000	275	800	250	630	225
1250	1250	30	63	70	300	600	1250	600	1000	325	800	300	630	250
1250	1250	25	52.5	70	350	725	1250	725	1000	400	800	350	630	300
1250	1250	15	30	70	425	850	1250	850	1000	675	800	600	630	525

Copper busbar enclosure depth 400 mm - 1250 A

Material: copper Cross section: 80 x 10 x 1 Minimum enclosure depth: 400 mm							Material: copper Cross section: 50 x 5 x 1	
Main busbar							Secondary distribution busbar	
Current / A IP30	Current / A IP55	I _{cw} 1s / kA	I _{pk} / kA	Distance C phase to phase / mm	Distance A support and enclosure / mm	Distance B support to support / mm	Current / A IP30 & IP55	Distance B support to support / mm
1250	1250	85	187	70	100	225	x	x
1250	1250	75	165	70	100	225	x	x
1250	1250	70	154	70	125	250	x	x
1250	1250	65	143	70	125	275	x	x
1250	1250	52	114.4	70	175	350	x	x
1250	1250	40	84	70	225	450	500	225
1250	1250	35	73.5	70	250	500	500	225
1250	1250	30	63	70	300	600	500	225
1250	1250	25	52.5	70	350	725	500	275
1250	1250	15	30	70	425	850	500	475

Copper busbar enclosure depth 400 mm - 1250 A

Material: copper Cross section: 80 x 10 x 1 Minimum enclosure depth: 400 mm							Material: aluminium Cross section: 60 x 18.5 x 1		Material: aluminium Cross section: 50 x 18.5 x 1	
Main busbar							Secondary distribution busbar			
Current / A IP30	Current / A IP55	I _{cw} 1s / kA	I _{pk} / kA	Distance C phase to phase / mm	Distance A support and enclosure / mm	Distance B support to support / mm	Current / A IP30 & IP55	Distance B support to support / mm	Current / A IP30 & IP55	Distance B support to support / mm
1250	1250	85	187	70	100	225	x	x	x	x
1250	1250	75	165	70	100	225	x	x	x	x
1250	1250	70	154	70	125	250	x	x	x	x
1250	1250	65	143	70	125	275	x	x	x	x
1250	1250	52	114.4	70	175	350	1250	300	x	x
1250	1250	40	84	70	225	450	1250	300	800	300
1250	1250	35	73.5	70	250	500	1250	300	800	300
1250	1250	30	63	70	300	600	1250	300	800	300
1250	1250	25	52.5	70	350	725	1250	300	800	300
1250	1250	15	30	70	425	850	1250	300	800	300

Copper busbar enclosure depth 400 mm - 1600 A

Material: copper Cross section: 120 x 10 x 1 Minimum enclosure depth: 400 mm							Material: copper Cross section: 120 x 10 x 1	Material: copper Cross section: 80 x 10 x 1	Material: copper Cross section: 100 x 5 x 1			
Main busbar							Secondary distribution busbar					
Current / A IP30	Current / A IP55	I _{cw} 1s / kA	I _{pk} / kA	Distance C phase to phase / mm	Distance A support and enclosure / mm	Distance B support to support / mm	Current / A IP30 & IP55	Distance B support to support / mm	Current / A IP30 & IP55	Distance B support to support / mm	Current / A IP30 & IP55	Distance B support to support / mm
1600	1600	85	187	70	100	225	1600	225	1250	225	x	x
1600	1600	75	165	70	125	275	1600	275	1250	225	x	x
1600	1600	70	154	70	150	300	1600	300	1250	250	x	x
1600	1600	65	143	70	150	325	1600	325	1250	275	1000	225
1600	1600	52	114.4	70	200	425	1600	425	1250	350	1000	225
1600	1600	40	84	70	275	550	1600	550	1250	450	1000	250
1600	1600	35	73.5	70	300	625	1600	625	1250	500	1000	275
1600	1600	30	63	70	350	725	1600	725	1250	600	1000	325
1600	1600	25	52.5	70	425	850	1600	850	1250	725	1000	400
1600	1600	15	30	70	425	850	1600	850	1250	850	1000	675

Copper busbar enclosure depth 400 mm - 1600 A

Material: copper Cross section: 120 x 10 x 1 Minimum enclosure depth: 400 mm							Material: copper Cross section: 80 x 5 x 1	Material: copper Cross section: 63 x 5 x 1	Material: copper Cross section: 50 x 5 x 1			
Main busbar							Secondary distribution busbar					
Current / A IP30	Current / A IP55	Icw 1s / kA	Ipk / kA	Distance C phase to phase / mm	Distance A support and enclosure / mm	Distance B support to support / mm	Current / A IP30 & IP55	Distance B support to support / mm	Current / A IP30 & IP55	Distance B support to support / mm	Current / A IP30 & IP55	Distance B support to support / mm
1600	1600	85	187	70	100	225	x	x	x	x	x	x
1600	1600	75	165	70	125	275	x	x	x	x	x	x
1600	1600	70	154	70	150	300	x	x	x	x	x	x
1600	1600	65	143	70	150	325	800	225	x	x	x	x
1600	1600	52	114.4	70	200	425	800	225	630	225	x	x
1600	1600	40	84	70	275	550	800	225	630	225	500	225
1600	1600	35	73.5	70	300	625	800	250	630	225	500	225
1600	1600	30	63	70	350	725	800	300	630	250	500	225
1600	1600	25	52.5	70	425	850	800	350	630	300	500	275
1600	1600	15	30	70	425	850	800	600	630	525	500	475

Copper busbar enclosure depth 400 mm - 1600 A

Material: copper Cross section: 120 x 10 x 1 Minimum enclosure depth: 400 mm							Material: aluminium Cross section: 100 x 18.5 x 1	Material: aluminium Cross section: 60 x 18.5 x 1	Material: aluminium Cross section: 50 x 18.5 x 1			
Main busbar							Secondary distribution busbar					
Current / A IP30	Current / A IP55	I _{cw} 1s / kA	I _{pk} / kA	Distance C phase to phase / mm	Distance A support and enclosure / mm	Distance B support to support / mm	Current / A IP30 & IP55	Distance B support to support / mm	Current / A IP30 & IP55	Distance B support to support / mm	Current / A IP30 & IP55	Distance B support to support / mm
1600	1600	85	187	70	100	225	x	x	x	x	x	x
1600	1600	75	165	70	125	275	x	x	x	x	x	x
1600	1600	70	154	70	150	300	1600	250	x	x	x	x
1600	1600	65	143	70	150	325	1600	250	x	x	x	x
1600	1600	52	114.4	70	200	425	1600	250	1250	300	x	x
1600	1600	40	84	70	275	550	1600	250	1250	300	800	300
1600	1600	35	73.5	70	300	625	1600	250	1250	300	800	300
1600	1600	30	63	70	350	725	1600	250	1250	300	800	300
1600	1600	25	52.5	70	425	850	1600	250	1250	300	800	300
1600	1600	15	30	70	425	850	1600	250	1250	300	800	300

3.4.3.2 Copper busbars, enclosure depth 600 mm - Technical data

Copper busbar enclosure depth 600 mm - 500 A

Material: copper Cross section: 50 x 5 x 1 Minimum enclosure depth: 600 mm							Material: copper Cross section: 50 x 5 x 1	
Main busbar							Secondary distribution busbar	
Current / A IP30	Current / A IP55	I _{cw} 1s / kA	I _{pk} / kA	Distance C phase to phase / mm	Distance A support and enclosure / mm	Distance B support to support / mm	Current / A IP30 & IP55	Distance B support to support / mm
500	500	40	84	100	100	225	500	225
500	500	35	73.5	100	100	225	500	225
500	500	30	63	100	100	225	500	225
500	500	25	52.5	100	125	275	500	275
500	500	15	30	100	225	475	500	475

Copper busbar enclosure depth 600 mm - 630 A

Material: copper Cross section: 63 x 5 x 1 Minimum enclosure depth: 600 mm							Material: copper Cross section: 63 x 5 x 1	Material: copper Cross section: 50 x 5 x 1		
Main busbar							Secondary distribution busbar			
Current / A IP30	Current / A IP55	I _{cw} 1s / kA	I _{pk} / kA	Distance C phase to phase / mm	Distance A support and enclosure / mm	Distance B support to support / mm	Current / A IP30 & IP55	Distance B support to support / mm	Current / A IP30 & IP55	Distance B support to support / mm
630	630	52	114.4	100	100	225	630	225	x	x
630	630	40	84	100	125	250	630	225	500	225
630	630	35	73.5	100	150	300	630	225	500	225
630	630	30	63	100	175	350	630	250	500	225
630	630	25	52.5	100	200	427	630	300	500	275
630	630	15	30	100	350	700	630	525	500	475

Copper busbar enclosure depth 600 mm - 630 A

Material: copper Cross section: 63 x 5 x 1 Minimum enclosure depth: 600 mm							Material: aluminium Cross section: 50 x 18.5 x 1	
Main busbar							Secondary distribution busbar	
Current / A IP30	Current / A IP55	I _{cw} 1s / kA	I _{pk} / kA	Distance C phase to phase / mm	Distance A support and enclosure / mm	Distance B support to support / mm	Current / A IP30 & IP55	Distance B support to support / mm
630	630	52	114.4	100	100	225	x	x
630	630	40	84	100	125	250	800	300
630	630	35	73.5	100	150	300	800	300
630	630	30	63	100	175	350	800	300
630	630	25	52.5	100	200	427	800	300
630	630	15	30	100	350	700	800	300

Copper busbar enclosure depth 600 mm - 800 A

Material: copper Cross section: 80 x 5 x 1 Minimum enclosure depth: 600 mm							Material: copper Cross section: 80 x 5 x 1	Material: copper Cross section: 63 x 5 x 1	Material: copper Cross section: 50 x 5 x 1			
Main busbar							Secondary distribution busbar					
Current / A IP30	Current / A IP55	Icw 1s / kA	Ipk / kA	Distance C phase to phase / mm	Distance A support and enclosure / mm	Distance B support to support / mm	Current / A IP30 & IP55	Distance B support to support / mm	Current / A IP30 & IP55	Distance B support to support / mm	Current / A IP30 & IP55	Distance B support to support / mm
800	800	65	143	100	100	225	800	225	x	x	x	x
800	800	52	114.4	100	100	225	800	225	630	225	x	x
800	800	40	84	100	150	300	800	300	630	225	500	225
800	800	35	73.5	100	150	325	800	325	630	225	500	225
800	800	30	63	100	200	400	800	400	630	250	500	225
800	800	25	52.5	100	225	475	800	475	630	300	500	275
800	800	15	30	100	400	800	800	800	630	525	500	475

Copper busbar enclosure depth 600 mm - 800 A

Material: copper Cross section: 80 x 5 x 1 Minimum enclosure depth: 600 mm							Material: aluminium Cross section: 50 x 18.5 x 1	
Main busbar							Secondary distribution busbar	
Current / A IP30	Current / A IP55	Icw 1s / kA	Ipk / kA	Distance C phase to phase / mm	Distance A support and enclosure / mm	Distance B support to support / mm	Current / A IP30 & IP55	Distance B support to support / mm
800	800	65	143	100	100	225	x	x
800	800	52	114.4	100	100	225	x	x
800	800	40	84	100	150	300	800	300
800	800	35	73.5	100	150	325	800	300
800	800	30	63	100	200	400	800	300
800	800	25	52.5	100	225	475	800	300
800	800	15	30	100	400	800	800	300

Copper busbar enclosure depth 600 mm - 1000 A

Material: copper Cross section: 100 x 5 x 1 Minimum enclosure depth: 600 mm							Material: copper Cross section: 100 x 5 x 1	Material: copper Cross section: 80 x 5 x 1	Material: copper Cross section: 63 x 5 x 1			
Main busbar							Secondary distribution busbar					
Current / A IP30	Current / A IP55	I _{cw} 1s / kA	I _{pk} / kA	Distance C phase to phase / mm	Distance A support and enclosure / mm	Distance B support to support / mm	Current / A IP30 & IP55	Distance B support to support / mm	Current / A IP30 & IP55	Distance B support to support / mm	Current / A IP30 & IP55	Distance B support to support / mm
1000	1000	85	187	100	100	225	1000	225	x	x	x	x
1000	1000	75	165	100	100	225	1000	225	x	x	x	x
1000	1000	70	154	100	100	225	1000	225	x	x	x	x
1000	1000	65	143	100	100	225	1000	225	800	225	x	x
1000	1000	52	114.4	100	125	250	1000	250	800	225	630	225
1000	1000	40	84	100	150	325	1000	325	800	300	630	225
1000	1000	35	73.5	100	175	375	1000	375	800	325	630	225
1000	1000	30	63	100	225	450	1000	450	800	400	630	250
1000	1000	25	52.5	100	250	525	1000	525	800	475	630	300
1000	1000	15	30	100	425	850	1000	850	800	800	630	525

Copper busbar enclosure depth 600 mm - 1000 A

Material: copper Cross section: 100 x 5 x 1 Minimum enclosure depth: 600 mm							Material: copper Cross section: 50 x 5 x 1	
Main busbar							Secondary distribution busbar	
Current / A IP30	Current / A IP55	Icw 1s / kA	Ipk / kA	Distance C phase to phase / mm	Distance A support and enclosure / mm	Distance B support to support / mm	Current / A IP30 & IP55	Distance B support to support / mm
1000	1000	85	187	100	100	225	x	x
1000	1000	75	165	100	100	225	x	x
1000	1000	70	154	100	100	225	x	x
1000	1000	65	143	100	100	225	x	x
1000	1000	52	114.4	100	125	250	x	x
1000	1000	40	84	100	150	325	500	225
1000	1000	35	73.5	100	175	375	500	225
1000	1000	30	63	100	225	450	500	225
1000	1000	25	52.5	100	250	525	500	275
1000	1000	15	30	100	425	850	500	475

Copper busbar enclosure depth 600 mm - 1000 A

Material: copper Cross section: 100 x 5 x 1 Minimum enclosure depth: 600 mm							Material: aluminium Cross section: 50 x 18.5 x 1	
Main busbar							Secondary distribution busbar	
Current / A IP30	Current / A IP55	I _{cw} 1s / kA	I _{pk} / kA	Distance C phase to phase / mm	Distance A support and enclosure / mm	Distance B support to support / mm	Current / A IP30 & IP55	Distance B support to support / mm
1000	1000	85	187	100	100	225	x	x
1000	1000	75	165	100	100	225	x	x
1000	1000	70	154	100	100	225	x	x
1000	1000	65	143	100	100	225	x	x
1000	1000	52	114.4	100	125	250	x	x
1000	1000	40	84	100	150	325	800	300
1000	1000	35	73.5	100	175	375	800	300
1000	1000	30	63	100	225	450	800	300
1000	1000	25	52.5	100	250	525	800	300
1000	1000	15	30	100	425	850	800	300

Copper busbar enclosure depth 600 mm - 1250 A

Material: copper Cross section: 80 x 10 x 1 Minimum enclosure depth: 600 mm							Material: copper Cross section: 80 x 10 x 1	Material: copper Cross section: 100 x 5 x 1	Material: copper Cross section: 80 x 5 x 1	Material: copper Cross section: 63 x 5 x 1				
Main busbar							Secondary distribution busbar							
Current / A IP30	Current / A IP55	I _{cw} 1s / kA	I _{pk} / kA	Distance C phase to phase / mm	Distance A support and enclosure / mm	Distance B support to support / mm	Current / A IP30 & IP55	Distance B support to support / mm	Current / A IP30 & IP55	Distance B support to support / mm	Current / A IP30 & IP55	Distance B support to support / mm	Current / A IP30 & IP55	Distance B support to support / mm
1250	1250	85	187	100	150	300	1250	300	1000	225	x	x	x	x
1250	1250	75	165	100	150	325	1250	325	1000	225	x	x	x	x
1250	1250	70	154	100	150	325	1250	325	1000	225	x	x	x	x
1250	1250	65	143	100	175	375	1250	375	1000	225	800	225	x	x
1250	1250	52	114.4	100	225	450	1250	450	1000	250	800	225	630	225
1250	1250	40	84	100	300	600	1250	600	1000	325	800	300	630	225
1250	1250	35	73.5	100	325	675	1250	675	1000	375	800	325	630	225
1250	1250	30	63	100	400	800	1250	800	1000	450	800	400	630	250
1250	1250	25	52.5	100	425	850	1250	850	1000	525	800	475	630	300
1250	1250	15	30	100	425	850	1250	850	1000	850	800	800	630	525

Copper busbar enclosure depth 600 mm - 1250 A

Material: copper Cross section: 80 x 10 x 1 Minimum enclosure depth: 600 mm							Material: copper Cross section: 50 x 5 x 1	
Main busbar							Secondary distribution busbar	
Current / A IP30	Current / A IP55	I _{cw} 1s / kA	I _{pk} / kA	Distance C phase to phase / mm	Distance A support and enclosure / mm	Distance B support to support / mm	Current / A IP30 & IP55	Distance B support to support / mm
1250	1250	85	187	100	150	300	x	x
1250	1250	75	165	100	150	325	x	x
1250	1250	70	154	100	150	325	x	x
1250	1250	65	143	100	175	375	x	x
1250	1250	52	114.4	100	225	450	x	x
1250	1250	40	84	100	300	600	500	225
1250	1250	35	73.5	100	325	675	500	225
1250	1250	30	63	100	400	800	500	225
1250	1250	25	52.5	100	425	850	500	275
1250	1250	15	30	100	425	850	500	475

Copper busbar enclosure depth 600 mm - 1250 A

Material: copper Cross section: 80 x 10 x 1 Minimum enclosure depth: 600 mm							Material: aluminium Cross section: 60 x 18.5 x 1		Material: aluminium Cross section: 50 x 18.5 x 1		
Main busbar							Secondary distribution busbar				
Current / A IP30	Current / A IP55	I _{cw} 1s / kA	I _{pk} / kA	Distance C phase to phase / mm	Distance A support and enclosure / mm	Distance B support to support / mm	Current / A IP30 & IP55	Distance B support to support / mm	Current / A IP30 & IP55	Distance B support to support / mm	
1250	1250	85	187	100	150	300	x	x	x	x	
1250	1250	75	165	100	150	325	x	x	x	x	
1250	1250	70	154	100	150	325	x	x	x	x	
1250	1250	65	143	100	175	375	x	x	x	x	
1250	1250	52	114.4	100	225	450	1250	300	x	x	
1250	1250	40	84	100	300	600	1250	300	800	300	
1250	1250	35	73.5	100	325	675	1250	300	800	300	
1250	1250	30	63	100	400	800	1250	300	800	300	
1250	1250	25	52.5	100	425	850	1250	300	800	300	
1250	1250	15	30	100	425	850	1250	300	800	300	

Copper busbar enclosure depth 600 mm - 1600 A

Material: copper Cross section: 120 x 10 x 1 Minimum enclosure depth: 600 mm							Material: copper Cross section: 120 x 10 x 1	Material: copper Cross section: 80 x 10 x 1	Material: copper Cross section: 100 x 5 x 1			
Main busbar							Secondary distribution busbar					
Current / A IP30	Current / A IP55	I _{cw} 1s / kA	I _{pk} / kA	Distance C phase to phase / mm	Distance A support and enclosure / mm	Distance B support to support / mm	Current / A IP30 & IP55	Distance B support to support / mm	Current / A IP30 & IP55	Distance B support to support / mm	Current / A IP30 & IP55	Distance B support to support / mm
1600	1600	85	187	100	175	350	1600	350	1250	300	1000	225
1600	1600	75	165	100	175	375	1600	375	1250	325	1000	225
1600	1600	70	154	100	175	376	1600	376	1250	325	1000	225
1600	1600	65	143	100	225	450	1600	450	1250	375	1000	225
1600	1600	52	114.4	100	275	575	1600	575	1250	450	1000	250
1600	1600	40	84	100	350	725	1600	725	1250	600	1000	325
1600	1600	35	73.5	100	425	850	1600	850	1250	675	1000	375
1600	1600	30	63	100	425	850	1600	850	1250	800	1000	450
1600	1600	25	52.5	100	425	850	1600	850	1250	850	1000	525
1600	1600	15	30	100	425	850	1600	850	1250	850	1000	850

Copper busbar enclosure depth 600 mm - 1600 A

Material: copper Cross section: 120 x 10 x 1 Minimum enclosure depth: 600 mm							Material: copper Cross section: 80 x 5 x 1	Material: copper Cross section: 63 x 5 x 1	Material: copper Cross section: 50 x 5 x 1			
Main busbar							Secondary distribution busbar					
Current / A IP30	Current / A IP55	Icw 1s / kA	Ipk / kA	Distance C phase to phase / mm	Distance A support and enclosure / mm	Distance B support to support / mm	Current / A IP30 & IP55	Distance B support to support / mm	Current / A IP30 & IP55	Distance B support to support / mm	Current / A IP30 & IP55	Distance B support to support / mm
1600	1600	85	187	100	175	350	x	x	x	x	x	x
1600	1600	75	165	100	175	375	x	x	x	x	x	x
1600	1600	70	154	100	175	376	x	x	x	x	x	x
1600	1600	65	143	100	225	450	800	225	x	x	x	x
1600	1600	52	114.4	100	275	575	800	225	630	225	x	x
1600	1600	40	84	100	350	725	800	300	630	225	500	225
1600	1600	35	73.5	100	425	850	800	325	630	225	500	225
1600	1600	30	63	100	425	850	800	400	630	250	500	225
1600	1600	25	52.5	100	425	850	800	475	630	300	500	275
1600	1600	15	30	100	425	850	800	800	630	525	500	475

Copper busbar enclosure depth 600 mm - 1600 A

Material: copper Cross section: 120 x 10 x 1 Minimum enclosure depth: 600 mm							Material: aluminium Cross section: 100 x 18.5 x 1	Material: aluminium Cross section: 60 x 18.5 x 1	Material: aluminium Cross section: 50 x 18.5 x 1			
Main busbar							Secondary distribution busbar					
Current / A IP30	Current / A IP55	I _{cw} 1s / kA	I _{pk} / kA	Distance C phase to phase / mm	Distance A support and enclosure / mm	Distance B support to support / mm	Current / A IP30 & IP55	Distance B support to support / mm	Current / A IP30 & IP55	Distance B support to support / mm	Current / A IP30 & IP55	Distance B support to support / mm
1600	1600	85	187	100	175	350	x	x	x	x	x	x
1600	1600	75	165	100	175	375	x	x	x	x	x	x
1600	1600	70	154	100	175	376	1600	250	x	x	x	x
1600	1600	65	143	100	225	450	1600	250	x	x	x	x
1600	1600	52	114.4	100	275	575	1600	250	1250	300	x	x
1600	1600	40	84	100	350	725	1600	250	1250	300	800	300
1600	1600	35	73.5	100	425	850	1600	250	1250	300	800	300
1600	1600	30	63	100	425	850	1600	250	1250	300	800	300
1600	1600	25	52.5	100	425	850	1600	250	1250	300	800	300
1600	1600	15	30	100	425	850	1600	250	1250	300	800	300

3.4.3.3 Copper busbars, enclosure depth 800 mm - Technical data

Copper busbar enclosure depth 800 mm - 500 A

Material: copper Cross section: 50 x 5 x 1 Minimum enclosure depth: 800 mm							Material: copper Cross section: 50 x 5 x 1	
Main busbar							Secondary distribution busbar	
Current / A IP30	Current / A IP55	Icw 1s / kA	Ipk / kA	Distance C phase to phase / mm	Distance A support and enclosure / mm	Distance B support to support / mm	Current / A IP30 & IP55	Distance B support to support / mm
500	500	40	84	100	100	225	500	225
500	500	35	73.5	100	100	225	500	225
500	500	30	63	100	100	225	500	225
500	500	25	52.5	100	125	275	500	275
500	500	15	30	100	225	475	500	475

Copper busbar enclosure depth 800 mm - 630 A

Material: copper Cross section: 63 x 5 x 1 Minimum enclosure depth: 800 mm							Material: copper Cross section: 63 x 5 x 1	Material: copper Cross section: 50 x 5 x 1		
Main busbar							Secondary distribution busbar			
Current / A IP30	Current / A IP55	Icw 1s / kA	Ipk / kA	Distance C phase to phase / mm	Distance A support and enclosure / mm	Distance B support to support / mm	Current / A IP30 & IP55	Distance B support to support / mm	Current / A IP30 & IP55	Distance B support to support / mm
630	630	52	114.4	100	100	225	630	225	x	x
630	630	40	84	100	100	250	630	225	500	225
630	630	35	73.5	100	100	300	630	225	500	225
630	630	30	63	100	125	350	630	250	500	225
630	630	25	52.5	100	150	427	630	300	500	275
630	630	15	30	100	250	700	630	525	500	475

Copper busbar enclosure depth 800 mm - 630 A

Material: copper Cross section: 63 x 5 x 1 Minimum enclosure depth: 800 mm							Material: aluminium Cross section: 50 x 18.5 x 1	
Main busbar							Secondary distribution busbar	
Current / A IP30	Current / A IP55	Icw 1s / kA	Ipk / kA	Distance C phase to phase / mm	Distance A support and enclosure / mm	Distance B support to support / mm	Current / A IP30 & IP55	Distance B support to support / mm
630	630	52	114.4	100	100	225	x	x
630	630	40	84	100	100	250	800	300
630	630	35	73.5	100	100	300	800	300
630	630	30	63	100	125	350	800	300
630	630	25	52.5	100	150	427	800	300
630	630	15	30	100	250	700	800	300

Copper busbar enclosure depth 800 mm - 800 A

Material: copper Cross section: 80 x 5 x 1 Minimum enclosure depth: 800 mm							Material: copper Cross section: 80 x 5 x 1	Material: copper Cross section: 63 x 5 x 1	Material: copper Cross section: 50 x 5 x 1			
Main busbar							Secondary distribution busbar					
Current / A IP30	Current / A IP55	Icw 1s / kA	Ipk / kA	Distance C phase to phase / mm	Distance A support and enclosure / mm	Distance B support to support / mm	Current / A IP30 & IP55	Distance B support to support / mm	Current / A IP30 & IP55	Distance B support to support / mm	Current / A IP30 & IP55	Distance B support to support / mm
800	800	65	143	100	100	225	800	225	x	x	x	x
800	800	52	114.4	100	100	225	800	225	630	225	x	x
800	800	40	84	100	100	300	800	300	630	225	500	225
800	800	35	73.5	100	125	325	800	325	630	225	500	225
800	800	30	63	100	150	400	800	400	630	250	500	225
800	800	25	52.5	100	175	475	800	475	630	300	500	275
800	800	15	30	100	300	800	800	800	630	525	500	475

Copper busbar enclosure depth 800 mm - 800 A

Material: copper Cross section: 80 x 5 x 1 Minimum enclosure depth: 800 mm							Material: aluminium Cross section: 50 x 18.5 x 1	
Main busbar							Secondary distribution busbar	
Current / A IP30	Current / A IP55	Icw 1s / kA	Ipk / kA	Distance C phase to phase / mm	Distance A support and enclosure / mm	Distance B support to support / mm	Current / A IP30 & IP55	Distance B support to support / mm
800	800	65	143	100	100	225	x	x
800	800	52	114.4	100	100	225	x	x
800	800	40	84	100	100	300	800	300
800	800	35	73.5	100	125	325	800	300
800	800	30	63	100	150	400	800	300
800	800	25	52.5	100	175	475	800	300
800	800	15	30	100	300	800	800	300

Copper busbar enclosure depth 800 mm - 1000 A

Material: copper Cross section: 100 x 5 x 1 Minimum enclosure depth: 800 mm							Material: copper Cross section: 100 x 5 x 1	Material: copper Cross section: 80 x 5 x 1	Material: copper Cross section: 63 x 5 x 1			
Main busbar							Secondary distribution busbar					
Current / A IP30	Current / A IP55	I _{cw} 1s / kA	I _{pk} / kA	Distance C phase to phase / mm	Distance A support and enclosure / mm	Distance B support to support / mm	Current / A IP30 & IP55	Distance B support to support / mm	Current / A IP30 & IP55	Distance B support to support / mm	Current / A IP30 & IP55	Distance B support to support / mm
1000	1000	85	187	100	100	225	1000	225	x	x	x	x
1000	1000	75	165	100	100	225	1000	225	x	x	x	x
1000	1000	70	154	100	100	225	1000	225	x	x	x	x
1000	1000	65	143	100	100	225	1000	225	800	225	x	x
1000	1000	52	114.4	100	125	250	1000	250	800	225	630	225
1000	1000	40	84	100	150	325	1000	325	800	300	630	225
1000	1000	35	73.5	100	175	375	1000	375	800	325	630	225
1000	1000	30	63	100	225	450	1000	450	800	400	630	250
1000	1000	25	52.5	100	250	525	1000	525	800	475	630	300
1000	1000	15	30	100	425	850	1000	850	800	800	630	525

Copper busbar enclosure depth 800 mm - 1000 A

Material: copper Cross section: 100 x 5 x 1 Minimum enclosure depth: 800 mm							Material: copper Cross section: 50 x 5 x 1	
Main busbar							Secondary distribution busbar	
Current / A IP30	Current / A IP55	I _{cw} 1s / kA	I _{pk} / kA	Distance C phase to phase / mm	Distance A support and enclosure / mm	Distance B support to support / mm	Current / A IP30 & IP55	Distance B support to support / mm
1000	1000	85	187	100	100	225	x	x
1000	1000	75	165	100	100	225	x	x
1000	1000	70	154	100	100	225	x	x
1000	1000	65	143	100	100	225	x	x
1000	1000	52	114.4	100	125	250	x	x
1000	1000	40	84	100	150	325	500	225
1000	1000	35	73.5	100	175	375	500	225
1000	1000	30	63	100	225	450	500	225
1000	1000	25	52.5	100	250	525	500	275
1000	1000	15	30	100	425	850	500	475

Copper busbar enclosure depth 800 mm - 1000 A

Material: copper Cross section: 100 x 5 x 1 Minimum enclosure depth: 800 mm							Material: aluminium Cross section: 50 x 18.5 x 1	
Main busbar							Secondary distribution busbar	
Current / A IP30	Current / A IP55	I _{cw} 1s / kA	I _{pk} / kA	Distance C phase to phase / mm	Distance A support and enclosure / mm	Distance B support to support / mm	Current / A IP30 & IP55	Distance B support to support / mm
1000	1000	85	187	100	TBD	225	x	x
1000	1000	75	165	100	TBD	225	x	x
1000	1000	70	154	100	TBD	225	x	x
1000	1000	65	143	100	TBD	225	x	x
1000	1000	52	114.4	100	TBD	250	x	x
1000	1000	40	84	100	TBD	325	800	300
1000	1000	35	73.5	100	TBD	375	800	300
1000	1000	30	63	100	TBD	450	800	300
1000	1000	25	52.5	100	TBD	525	800	300
1000	1000	15	30	100	TBD	850	800	300

Copper busbar enclosure depth 800 mm - 1250 A

Material: copper Cross section: 80 x 10 x 1 Minimum enclosure depth: 800 mm							Material: copper Cross section: 80 x 10 x 1	Material: copper Cross section: 100 x 5 x 1	Material: copper Cross section: 80 x 5 x 1	Material: copper Cross section: 63 x 5 x 1				
Main busbar							Secondary distribution busbar							
Current / A IP30	Current / A IP55	Icw 1s / kA	Ipk / kA	Distance C phase to phase / mm	Distance A support and enclosure / mm	Distance B support to support / mm	Current / A IP30 & IP55	Distance B support to support / mm	Current / A IP30 & IP55	Distance B support to support / mm	Current / A IP30 & IP55	Distance B support to support / mm	Current / A IP30 & IP55	Distance B support to support / mm
1250	1250	85	187	100	150	300	1250	300	1000	225	x	x	x	x
1250	1250	75	165	100	150	325	1250	325	1000	225	x	x	x	x
1250	1250	70	154	100	150	325	1250	325	1000	225	x	x	x	x
1250	1250	65	143	100	175	375	1250	375	1000	225	800	225	x	x
1250	1250	52	114.4	100	225	450	1250	450	1000	250	800	225	630	225
1250	1250	40	84	100	300	600	1250	600	1000	325	800	300	630	225
1250	1250	35	73.5	100	325	675	1250	675	1000	375	800	325	630	225
1250	1250	30	63	100	400	800	1250	800	1000	450	800	400	630	250
1250	1250	25	52.5	100	425	850	1250	850	1000	525	800	475	630	300
1250	1250	15	30	100	425	850	1250	850	1000	850	800	800	630	525

Copper busbar enclosure depth 800 mm - 1250 A

Material: copper Cross section: 80 x 10 x 1 Minimum enclosure depth: 800 mm							Material: copper Cross section: 50 x 5 x 1	
Main busbar							Secondary distribution busbar	
Current / A IP30	Current / A IP55	I _{cw} 1s / kA	I _{pk} / kA	Distance C phase to phase / mm	Distance A support and enclosure / mm	Distance B support to support / mm	Current / A IP30 & IP55	Distance B support to support / mm
1250	1250	85	187	100	150	300	x	x
1250	1250	75	165	100	150	325	x	x
1250	1250	70	154	100	150	325	x	x
1250	1250	65	143	100	175	375	x	x
1250	1250	52	114.4	100	225	450	x	x
1250	1250	40	84	100	300	600	500	225
1250	1250	35	73.5	100	325	675	500	225
1250	1250	30	63	100	400	800	500	225
1250	1250	25	52.5	100	425	850	500	275
1250	1250	15	30	100	425	850	500	475

Copper busbar enclosure depth 800 mm - 1250 A

Material: copper Cross section: 80 x 10 x 1 Minimum enclosure depth: 800 mm							Material: aluminium Cross section: 60 x 18.5 x 1		Material: aluminium Cross section: 50 x 18.5 x 1	
Main busbar							Secondary distribution busbar			
Current / A IP30	Current / A IP55	Icw 1s / kA	Ipk / kA	Distance C phase to phase / mm	Distance A support and enclosure / mm	Distance B support to support / mm	Current / A IP30 & IP55	Distance B support to support / mm	Current / A IP30 & IP55	Distance B support to support / mm
1250	1250	85	187	100	150	300	x	x	x	x
1250	1250	75	165	100	150	325	x	x	x	x
1250	1250	70	154	100	150	325	x	x	x	x
1250	1250	65	143	100	175	375	x	x	x	x
1250	1250	52	114.4	100	225	450	1250	300	x	x
1250	1250	40	84	100	300	600	1250	300	800	300
1250	1250	35	73.5	100	325	675	1250	300	800	300
1250	1250	30	63	100	400	800	1250	300	800	300
1250	1250	25	52.5	100	425	850	1250	300	800	300
1250	1250	15	30	100	425	850	1250	300	800	300

Copper busbar enclosure depth 800 mm - 1600 A

Material: copper Cross section: 120 x 10 x 1 Minimum enclosure depth: 800 mm							Material: copper Cross section: 120 x 10 x 1	Material: copper Cross section: 80 x 10 x 1	Material: copper Cross section: 100 x 5 x 1			
Main busbar							Secondary distribution busbar					
Current / A IP30	Current / A IP55	I _{cw} 1s / kA	I _{pk} / kA	Distance C phase to phase / mm	Distance A support and enclosure / mm	Distance B support to support / mm	Current / A IP30 & IP55	Distance B support to support / mm	Current / A IP30 & IP55	Distance B support to support / mm	Current / A IP30 & IP55	Distance B support to support / mm
1600	1600	85	187	100	175	350	1600	350	1250	300	1000	225
1600	1600	75	165	100	175	375	1600	375	1250	325	1000	225
1600	1600	70	154	100	175	376	1600	376	1250	325	1000	225
1600	1600	65	143	100	225	450	1600	450	1250	375	1000	225
1600	1600	52	114.4	100	275	575	1600	575	1250	450	1000	250
1600	1600	40	84	100	350	725	1600	725	1250	600	1000	325
1600	1600	35	73.5	100	425	850	1600	850	1250	675	1000	375
1600	1600	30	63	100	425	850	1600	850	1250	800	1000	450
1600	1600	25	52.5	100	425	850	1600	850	1250	850	1000	525
1600	1600	15	30	100	425	850	1600	850	1250	850	1000	850

Copper busbar enclosure depth 800 mm - 1600 A

Material: copper Cross section: 120 x 10 x 1 Minimum enclosure depth: 800 mm							Material: copper Cross section: 80 x 5 x 1	Material: copper Cross section: 63 x 5 x 1	Material: copper Cross section: 50 x 5 x 1			
Main busbar							Secondary distribution busbar					
Current / A IP30	Current / A IP55	Icw 1s / kA	Ipk / kA	Distance C phase to phase / mm	Distance A support and enclosure / mm	Distance B support to support / mm	Current / A IP30 & IP55	Distance B support to support / mm	Current / A IP30 & IP55	Distance B support to support / mm	Current / A IP30 & IP55	Distance B support to support / mm
1600	1600	85	187	100	175	350	x	x	x	x	x	x
1600	1600	75	165	100	175	375	x	x	x	x	x	x
1600	1600	70	154	100	175	376	x	x	x	x	x	x
1600	1600	65	143	100	225	450	800	225	x	x	x	x
1600	1600	52	114.4	100	275	575	800	225	630	225	x	x
1600	1600	40	84	100	350	725	800	300	630	225	500	225
1600	1600	35	73.5	100	425	850	800	325	630	225	500	225
1600	1600	30	63	100	425	850	800	400	630	250	500	225
1600	1600	25	52.5	100	425	850	800	475	630	300	500	275
1600	1600	15	30	100	425	850	800	800	630	525	500	475

Copper busbar enclosure depth 800 mm - 1600 A

Material: copper Cross section: 120 x 10 x 1 Minimum enclosure depth: 800 mm							Material: aluminium Cross section: 100 x 18.5 x 1	Material: aluminium Cross section: 60 x 18.5 x 1	Material: aluminium Cross section: 50 x 18.5 x 1			
Main busbar							Secondary distribution busbar					
Current / A IP30	Current / A IP55	I _{cw} 1s / kA	I _{pk} / kA	Distance C phase to phase / mm	Distance A support and enclosure / mm	Distance B support to support / mm	Current / A IP30 & IP55	Distance B support to support / mm	Current / A IP30 & IP55	Distance B support to support / mm	Current / A IP30 & IP55	Distance B support to support / mm
1600	1600	85	187	100	175	350	x	x	x	x	x	x
1600	1600	75	165	100	175	375	x	x	x	x	x	x
1600	1600	70	154	100	175	376	1600	250	x	x	x	x
1600	1600	65	143	100	225	450	1600	250	x	x	x	x
1600	1600	52	114.4	100	275	575	1600	250	1250	300	x	x
1600	1600	40	84	100	350	725	1600	250	1250	300	800	300
1600	1600	35	73.5	100	425	850	1600	250	1250	300	800	300
1600	1600	30	63	100	425	850	1600	250	1250	300	800	300
1600	1600	25	52.5	100	425	850	1600	250	1250	300	800	300
1600	1600	15	30	100	425	850	1600	250	1250	300	800	300

Copper busbar enclosure depth 800 mm - 2000 A

Material: copper Cross section: 80 x 10 x 2 Minimum enclosure depth: 800 mm							Material: copper Cross section: 120 x 10 x 1	Material: copper Cross section: 80 x 10 x 1	Material: copper Cross section: 100 x 5 x 1			
Main busbar							Secondary distribution busbar					
Current / A IP30	Current / A IP55	Icw 1s / kA	Ipk / kA	Distance C phase to phase / mm	Distance A support and enclosure / mm	Distance B support to support / mm	Current / A IP30 & IP55	Distance B support to support / mm	Current / A IP30 & IP55	Distance B support to support / mm	Current / A IP30 & IP55	Distance B support to support / mm
2000	1700	85	187	125	150	325	1600	350	1250	300	1000	225
2000	1700	75	165	125	150	325	1600	375	1250	325	1000	225
2000	1700	70	154	125	175	350	1600	376	1250	325	1000	225
2000	1700	65	143	125	175	375	1600	450	1250	375	1000	225
2000	1700	52	114.4	125	225	475	1600	575	1250	450	1000	250
2000	1700	40	84	125	300	625	1600	725	1250	600	1000	325
2000	1700	35	73.5	125	350	700	1600	850	1250	675	1000	375
2000	1700	30	63	125	400	825	1600	850	1250	800	1000	450
2000	1700	25	52.5	125	425	850	1600	850	1250	850	1000	525
2000	1700	15	30	125	425	850	1600	850	1250	850	1000	850

Copper busbar enclosure depth 800 mm - 2000 A

Material: copper Cross section: 80 x 10 x 2 Minimum enclosure depth: 800 mm							Material: copper Cross section: 80 x 5 x 1	Material: copper Cross section: 63 x 5 x 1	Material: copper Cross section: 50 x 5 x 1			
Main busbar							Secondary distribution busbar					
Current / A IP30	Current / A IP55	I _{cw} 1s / kA	I _{pk} / kA	Distance C phase to phase / mm	Distance A support and enclosure / mm	Distance B support to support / mm	Current / A IP30 & IP55	Distance B support to support / mm	Current / A IP30 & IP55	Distance B support to support / mm	Current / A IP30 & IP55	Distance B support to support / mm
2000	1700	85	187	125	150	325	x	x	x	x	x	x
2000	1700	75	165	125	150	325	x	x	x	x	x	x
2000	1700	70	154	125	175	350	x	x	x	x	x	x
2000	1700	65	143	125	175	375	800	225	x	x	x	x
2000	1700	52	114.4	125	225	475	800	225	630	225	x	x
2000	1700	40	84	125	300	625	800	300	630	225	500	225
2000	1700	35	73.5	125	350	700	800	325	630	225	500	225
2000	1700	30	63	125	400	825	800	400	630	250	500	225
2000	1700	25	52.5	125	425	850	800	475	630	300	500	275
2000	1700	15	30	125	425	850	800	800	630	525	500	475

Copper busbar enclosure depth 800 mm - 2000 A

Material: copper Cross section: 80 x 10 x 2 Minimum enclosure depth: 800 mm							Material: aluminium Cross section: 100 x 18.5 x 1	Material: aluminium Cross section: 60 x 18.5 x 1	Material: aluminium Cross section: 50 x 18.5 x 1			
Main busbar							Secondary distribution busbar					
Current / A IP30	Current / A IP55	Icw 1s / kA	Ipk / kA	Distance C phase to phase / mm	Distance A support and enclosure / mm	Distance B support to support / mm	Current / A IP30 & IP55	Distance B support to support / mm	Current / A IP30 & IP55	Distance B support to support / mm	Current / A IP30 & IP55	Distance B support to support / mm
2000	1700	85	187	125	150	325	x	x	x	x	x	x
2000	1700	75	165	125	150	325	x	x	x	x	x	x
2000	1700	70	154	125	175	350	1600	250	x	x	x	x
2000	1700	65	143	125	175	375	1600	250	x	x	x	x
2000	1700	52	114.4	125	225	475	1600	250	1250	300	x	x
2000	1700	40	84	125	300	625	1600	250	1250	300	800	300
2000	1700	35	73.5	125	350	700	1600	250	1250	300	800	300
2000	1700	30	63	125	400	825	1600	250	1250	300	800	300
2000	1700	25	52.5	125	425	850	1600	250	1250	300	800	300
2000	1700	15	30	125	425	850	1600	250	1250	300	800	300

Copper busbar enclosure depth 800 mm - 2500 A

Material: copper Cross section: 100 x 10 x 2 Minimum enclosure depth: 800 mm							Material: copper Cross section: 120 x 10 x 1	Material: copper Cross section: 80 x 10 x 1	Material: copper Cross section: 100 x 5 x 1			
Main busbar							Secondary distribution busbar					
Current / A IP30	Current / A IP55	I _{cw} 1s / kA	I _{pk} / kA	Distance C phase to phase / mm	Distance A support and enclosure / mm	Distance B support to support / mm	Current / A IP30 & IP55	Distance B support to support / mm	Current / A IP30 & IP55	Distance B support to support / mm	Current / A IP30 & IP55	Distance B support to support / mm
2500	2125	85	187	150	150	325	1600	350	1250	300	1000	225
2500	2125	75	165	150	175	375	1600	375	1250	325	1000	225
2500	2125	70	154	150	200	400	1600	376	1250	325	1000	225
2500	2125	65	143	150	225	450	1600	450	1250	375	1000	225
2500	2125	52	114.4	150	275	550	1600	575	1250	450	1000	250
2500	2125	40	84	150	350	725	1600	725	1250	600	1000	325
2500	2125	35	73.5	150	400	825	1600	850	1250	675	1000	375
2500	2125	30	63	150	425	850	1600	850	1250	800	1000	450
2500	2125	25	52.5	150	425	850	1600	850	1250	850	1000	525
2500	2125	15	30	150	425	850	1600	850	1250	850	1000	850

Copper busbar enclosure depth 800 mm - 2500 A

Material: copper Cross section: 100 x 10 x 2 Minimum enclosure depth: 800 mm							Material: copper Cross section: 80 x 5 x 1	Material: copper Cross section: 63 x 5 x 1	Material: copper Cross section: 50 x 5 x 1			
Main busbar							Secondary distribution busbar					
Current / A IP30	Current / A IP55	Icw 1s / kA	Ipk / kA	Distance C phase to phase / mm	Distance A support and enclosure / mm	Distance B support to support / mm	Current / A IP30 & IP55	Distance B support to support / mm	Current / A IP30 & IP55	Distance B support to support / mm	Current / A IP30 & IP55	Distance B support to support / mm
2500	2125	85	187	150	150	325	x	x	x	x	x	x
2500	2125	75	165	150	175	375	x	x	x	x	x	x
2500	2125	70	154	150	200	400	x	x	x	x	x	x
2500	2125	65	143	150	225	450	800	225	x	x	x	x
2500	2125	52	114.4	150	275	550	800	225	630	225	x	x
2500	2125	40	84	150	350	725	800	300	630	225	500	225
2500	2125	35	73.5	150	400	825	800	325	630	225	500	225
2500	2125	30	63	150	425	850	800	400	630	250	500	225
2500	2125	25	52.5	150	425	850	800	475	630	300	500	275
2500	2125	15	30	150	425	850	800	800	630	525	500	475

Copper busbar enclosure depth 800 mm - 2500 A

Material: copper Cross section: 100 x 10 x 2 Minimum enclosure depth: 800 mm							Material: aluminium Cross section: 100 x 18.5 x 1	Material: aluminium Cross section: 60 x 18.5 x 1	Material: aluminium Cross section: 50 x 18.5 x 1			
Main busbar							Secondary distribution busbar					
Current / A IP30	Current / A IP55	I _{cw} 1s / kA	I _{pk} / kA	Distance C phase to phase / mm	Distance A support and enclosure / mm	Distance B support to support / mm	Current / A IP30 & IP55	Distance B support to support / mm	Current / A IP30 & IP55	Distance B support to support / mm	Current / A IP30 & IP55	Distance B support to support / mm
2500	2125	85	187	150	150	325	x	x	x	x	x	x
2500	2125	75	165	150	175	375	x	x	x	x	x	x
2500	2125	70	154	150	200	400	1600	250	x	x	x	x
2500	2125	65	143	150	225	450	1600	250	x	x	x	x
2500	2125	52	114.4	150	275	550	1600	250	1250	300	x	x
2500	2125	40	84	150	350	725	1600	250	1250	300	800	300
2500	2125	35	73.5	150	400	825	1600	250	1250	300	800	300
2500	2125	30	63	150	425	850	1600	250	1250	300	800	300
2500	2125	25	52.5	150	425	850	1600	250	1250	300	800	300
2500	2125	15	30	150	425	850	1600	250	1250	300	800	300

Copper busbar enclosure depth 800 mm - 3200 A

Material: copper Cross section: 100 x 10 x 3 Minimum enclosure depth: 800 mm							Material: copper Cross section: 120 x 10 x 1	Material: copper Cross section: 80 x 10 x 1	Material: copper Cross section: 100 x 5 x 1			
Main busbar							Secondary distribution busbar					
Current / A IP30	Current / A IP55	Icw 1s / kA	Ipk / kA	Distance C phase to phase / mm	Distance A support and enclosure / mm	Distance B support to support / mm	Current / A IP30 & IP55	Distance B support to support / mm	Current / A IP30 & IP55	Distance B support to support / mm	Current / A IP30 & IP55	Distance B support to support / mm
3200	2720	85	187	150	200	400	1600	350	1250	300	1000	225
3200	2720	75	165	150	225	475	1600	375	1250	325	1000	225
3200	2720	70	154	150	225	476	1600	376	1250	325	1000	225
3200	2720	65	143	150	275	550	1600	450	1250	375	1000	225
3200	2720	52	114.4	150	325	675	1600	575	1250	450	1000	250
3200	2720	40	84	150	425	850	1600	725	1250	600	1000	325
3200	2720	35	73.5	150	425	850	1600	850	1250	675	1000	375
3200	2720	30	63	150	425	850	1600	850	1250	800	1000	450
3200	2720	25	52.5	150	425	850	1600	850	1250	850	1000	525
3200	2720	15	30	150	425	850	1600	850	1250	850	1000	850

Copper busbar enclosure depth 800 mm - 3200 A

Material: copper Cross section: 100 x 10 x 3 Minimum enclosure depth: 800 mm							Material: copper Cross section: 80 x 5 x 1	Material: copper Cross section: 63 x 5 x 1	Material: copper Cross section: 50 x 5 x 1			
Main busbar							Secondary distribution busbar					
Current / A IP30	Current / A IP55	I _{cw} 1s / kA	I _{pk} / kA	Distance C phase to phase / mm	Distance A support and enclosure / mm	Distance B support to support / mm	Current / A IP30 & IP55	Distance B support to support / mm	Current / A IP30 & IP55	Distance B support to support / mm	Current / A IP30 & IP55	Distance B support to support / mm
3200	2720	85	187	150	200	400	x	x	x	x	x	x
3200	2720	75	165	150	225	475	x	x	x	x	x	x
3200	2720	70	154	150	225	476	x	x	x	x	x	x
3200	2720	65	143	150	275	550	800	225	x	x	x	x
3200	2720	52	114.4	150	325	675	800	225	630	225	x	x
3200	2720	40	84	150	425	850	800	300	630	225	500	225
3200	2720	35	73.5	150	425	850	800	325	630	225	500	225
3200	2720	30	63	150	425	850	800	400	630	250	500	225
3200	2720	25	52.5	150	425	850	800	475	630	300	500	275
3200	2720	15	30	150	425	850	800	800	630	525	500	475

Copper busbar enclosure depth 800 mm - 3200 A

Material: copper Cross section: 100 x 10 x 3 Minimum enclosure depth: 800 mm							Material: aluminium Cross section: 100 x 18.5 x 1	Material: aluminium Cross section: 60 x 18.5 x 1	Material: aluminium Cross section: 50 x 18.5 x 1			
Main busbar							Secondary distribution busbar					
Current / A IP30	Current / A IP55	Icw 1s / kA	Ipk / kA	Distance C phase to phase / mm	Distance A support and enclosure / mm	Distance B support to support / mm	Current / A IP30 & IP55	Distance B support to support / mm	Current / A IP30 & IP55	Distance B support to support / mm	Current / A IP30 & IP55	Distance B support to support / mm
3200	2720	85	187	150	200	400	x	x	x	x	x	x
3200	2720	75	165	150	225	475	x	x	x	x	x	x
3200	2720	70	154	150	225	476	1600	250	x	x	x	x
3200	2720	65	143	150	275	550	1600	250	x	x	x	x
3200	2720	52	114.4	150	325	675	1600	250	1250	300	x	x
3200	2720	40	84	150	425	850	1600	250	1250	300	800	300
3200	2720	35	73.5	150	425	850	1600	250	1250	300	800	300
3200	2720	30	63	150	425	851	1600	250	1250	300	800	300
3200	2720	25	52.5	150	425	852	1600	250	1250	300	800	300
3200	2720	15	30	150	425	853	1600	250	1250	300	800	300

Copper busbar enclosure depth 800 mm - 4000 A

Material: copper Cross section: 120 x 10 x 3 Minimum enclosure depth: 800 mm							Material: copper Cross section: 120 x 10 x 1	Material: copper Cross section: 80 x 10 x 1	Material: copper Cross section: 100 x 5 x 1			
Main busbar							Secondary distribution busbar					
Current / A IP30	Current / A IP55	I _{cw} 1s / kA	I _{pk} / kA	Distance C phase to phase / mm	Distance A support and enclosure / mm	Distance B support to support / mm	Current / A IP30 & IP55	Distance B support to support / mm	Current / A IP30 & IP55	Distance B support to support / mm	Current / A IP30 & IP55	Distance B support to support / mm
4000	3400	85	187	150	200	400	1600	350	1250	300	1000	225
4000	3400	75	165	150	250	525	1600	375	1250	325	1000	225
4000	3400	70	154	150	275	575	1600	376	1250	325	1000	225
4000	3400	65	143	150	300	625	1600	450	1250	375	1000	225
4000	3400	52	114.4	150	375	775	1600	575	1250	450	1000	250
4000	3400	40	84	150	425	850	1600	725	1250	600	1000	325
4000	3400	35	73.5	150	425	850	1600	850	1250	675	1000	375
4000	3400	30	63	150	425	850	1600	850	1250	800	1000	450
4000	3400	25	52.5	150	425	850	1600	850	1250	850	1000	525
4000	3400	15	30	150	425	850	1600	850	1250	850	1000	850

Copper busbar enclosure depth 800 mm - 4000 A

Material: copper Cross section: 120 x 10 x 3 Minimum enclosure depth: 800 mm							Material: copper Cross section: 80 x 5 x 1	Material: copper Cross section: 63 x 5 x 1	Material: copper Cross section: 50 x 5 x 1			
Main busbar							Secondary distribution busbar					
Current / A IP30	Current / A IP55	Icw 1s / kA	Ipk / kA	Distance C phase to phase / mm	Distance A support and enclosure / mm	Distance B support to support / mm	Current / A IP30 & IP55	Distance B support to support / mm	Current / A IP30 & IP55	Distance B support to support / mm	Current / A IP30 & IP55	Distance B support to support / mm
4000	3400	85	187	150	200	400	x	x	x	x	x	x
4000	3400	75	165	150	250	525	x	x	x	x	x	x
4000	3400	70	154	150	275	575	x	x	x	x	x	x
4000	3400	65	143	150	300	625	800	225	x	x	x	x
4000	3400	52	114.4	150	375	775	800	225	630	225	x	x
4000	3400	40	84	150	425	850	800	300	630	225	500	225
4000	3400	35	73.5	150	425	850	800	325	630	225	500	225
4000	3400	30	63	150	425	850	800	400	630	250	500	225
4000	3400	25	52.5	150	425	850	800	475	630	300	500	275
4000	3400	15	30	150	425	850	800	800	630	525	500	475

Copper busbar enclosure depth 800 mm - 4000 A

Material: copper Cross section: 120 x 10 x 3 Minimum enclosure depth: 800 mm							Material: aluminium Cross section: 100 x 18.5 x 1	Material: aluminium Cross section: 60 x 18.5 x 1	Material: aluminium Cross section: 50 x 18.5 x 1			
Main busbar							Secondary distribution busbar					
Current / A IP30	Current / A IP55	I _{cw} 1s / kA	I _{pk} / kA	Distance C phase to phase / mm	Distance A support and enclosure / mm	Distance B support to support / mm	Current / A IP30 & IP55	Distance B support to support / mm	Current / A IP30 & IP55	Distance B support to support / mm	Current / A IP30 & IP55	Distance B support to support / mm
4000	3400	85	187	150	200	400	x	x	x	x	x	x
4000	3400	75	165	150	250	525	x	x	x	x	x	x
4000	3400	70	154	150	275	575	1600	250	x	x	x	x
4000	3400	65	143	150	300	625	1600	250	x	x	x	x
4000	3400	52	114.4	150	375	775	1600	250	1250	300	x	x
4000	3400	40	84	150	425	850	1600	250	1250	300	800	300
4000	3400	35	73.5	150	425	850	1600	250	1250	300	800	300
4000	3400	30	63	150	425	850	1600	250	1250	300	800	300
4000	3400	25	52.5	150	425	850	1600	250	1250	300	800	300
4000	3400	15	30	150	425	850	1600	250	1250	300	800	300

3.4.3.4 Copper busbars and Service Index 223 & 233 - Technical data

Copper busbar enclosure depth 600 mm - 1250 A

Material: copper Cross section: 80 x 10 x 1 Minimum enclosure depth: 600 mm							Material: copper Cross section: 50 x 10 x 1	Material: copper Cross section: 40 x 10 x 1		
Main busbar							SX busbar			
Current / A IP30	Current / A IP55	Icw 1s / kA	Ipk / kA	Distance ph. to ph. / mm	Distance A support and enclosure / mm	Distance B support to support / mm	Current / A IP30 & IP55	Distance B support to support / mm	Current / A IP30 & IP55	Distance B support to support / mm
1250	1250	85	187	100	150	300	x	x		
1250	1250	75	165	100	150	325	x	x		
1250	1250	70	154	100	150	325	x	x		
1250	1250	65	143	100	175	375	x	x		
1250	1250	52	114.4	100	225	450	1000	250	800	250
1250	1250	40	84	100	300	600	1000	300	800	300
1250	1250	35	73.5	100	325	675	1000	300	800	300
1250	1250	30	63	100	400	800	1000	400	800	400
1250	1250	25	52.5	100	425	850	1000	400	800	400
1250	1250	15	30	100	425	850	1000	500	800	500

Copper busbar enclosure depth 600 mm - 1600 A

Material: copper Cross section: 120 x 10 x 1 Minimum enclosure depth: 600 mm							Material: copper Cross section: 80 x 10 x 1	Material: copper Cross section: 50 x 10 x 1	Material: copper Cross section: 40 x 10 x 1			
Main busbar							SX busbar					
Current / A IP30	Current / A IP55	I _{cw} 1s / kA	I _{pk} / kA	Distance ph. to ph. / mm	Distance A support and enclosure / mm	Distance B support to support / mm	Current / A IP30 & IP55	Distance B support to support / mm	Current / A IP30 & IP55	Distance B support to support / mm	Current / A IP30 & IP55	Distance B support to support / mm
1600	1600	85	187	100	175	350	1600	200				
1600	1600	75	165	100	175	375	1600	200				
1600	1600	70	154	100	175	375	1600	250				
1600	1600	65	143	100	225	450	1600	250				
1600	1600	52	114.4	100	275	575	1600	300	1000	200	800	250
1600	1600	40	84	100	350	725	1600	400	1000	300	800	300
1600	1600	35	73.5	100	425	850	1600	400	1000	300	800	300
1600	1600	30	63	100	425	850	1600	400	1000	400	800	400
1600	1600	25	52.5	100	425	850	1600	500	1000	400	800	400
1600	1600	15	30	100	425	850	1600	500	1000	500	800	500

Copper busbar enclosure depth 800 mm - 1250 A

Material: copper Cross section: 80 x 10 x 1 Minimum enclosure depth: 800 mm							Material: copper Cross section: 50 x 10 x 1	Material: copper Cross section: 40 x 10 x 1		
Main busbar							SX busbar			
Current / A IP30	Current / A IP55	I _{cw} 1s / kA	I _{pk} / kA	Distance ph. to ph. / mm	Distance A support and enclosure / mm	Distance B support to support / mm	Current / A IP30 & IP55	Distance B support to support / mm	Current / A IP30 & IP55	Distance B support to support / mm
1250	1250	85	187	100	150	300				
1250	1250	75	165	100	150	325				
1250	1250	70	154	100	150	325				
1250	1250	65	143	100	175	375				
1250	1250	52	114.4	100	225	450	1000	250	800	250
1250	1250	40	84	100	300	600	1000	300	800	300
1250	1250	35	73.5	100	325	675	1000	300	800	300
1250	1250	30	63	100	400	800	1000	400	800	400
1250	1250	25	52.5	100	425	850	1000	400	800	400
1250	1250	15	30	100	425	850	1000	500	800	500

Copper busbar enclosure depth 800 mm - 1600 A

Material: copper Cross section: 120 x 10 x 1 Minimum enclosure depth: 800 mm							Material: copper Cross section: 80 x 10 x 1		Material: copper Cross section: 50 x 10 x 1		Material: copper Cross section: 40 x 10 x 1	
Main busbar							SX busbar					
Current / A IP30	Current / A IP55	I _{cw} 1s / kA	I _{pk} / kA	Distance ph. to ph. / mm	Distance A support and enclosure / mm	Distance B support to support / mm	Current / A IP30 & IP55	Distance B support to support / mm	Current / A IP30 & IP55	Distance B support to support / mm	Current / A IP30 & IP55	Distance B support to support / mm
1600	1600	85	187	100	175	350	1600	200				
1600	1600	75	165	100	175	375	1600	200				
1600	1600	70	154	100	175	375	1600	250				
1600	1600	65	143	100	225	450	1600	250				
1600	1600	52	114.4	100	275	575	1600	300	1000	250	800	250
1600	1600	40	84	100	350	725	1600	400	1000	300	800	300
1600	1600	35	73.5	100	425	850	1600	400	1000	300	800	300
1600	1600	30	63	100	425	850	1600	400	1000	400	800	400
1600	1600	25	52.5	100	425	850	1600	500	1000	400	800	400
1600	1600	15	30	100	425	850	1600	500	1000	500	800	500

Copper busbar enclosure depth 800 mm - 2000 A

Material: copper Cross section: 80 x 10 x 2 Minimum enclosure depth: 800 mm							Material: copper Cross section: 120 x 10 x 1	Material: copper Cross section: 80 x 10 x 1		
Main busbar							SX busbar			
Current / A IP30	Current / A IP55	Icw 1s / kA	Ipk / kA	Distance ph. to ph. / mm	Distance A support and enclosure / mm	Distance B support to support / mm	Current / A IP30 & IP55	Distance B support to support / mm	Current / A IP30 & IP55	Distance B support to support / mm
2000	1700	85	187	100	150	325	2000	200	1600	200
2000	1700	75	165	100	150	325	2000	250	1600	200
2000	1700	70	154	100	175	350	2000	250	1600	250
2000	1700	65	143	100	175	375	2000	300	1600	250
2000	1700	52	114.4	100	225	475	2000	400	1600	300
2000	1700	40	84	100	300	625	2000	400	1600	400
2000	1700	35	73.5	100	350	700	2000	400	1600	400
2000	1700	30	63	100	400	825	2000	500	1600	400
2000	1700	25	52.5	100	425	850	2000	500	1600	500
2000	1700	15	30	100	425	850	2000	500	1600	500

Copper busbar enclosure depth 800 mm - 2000 A

Material: copper Cross section: 80 x 10 x 2 Minimum enclosure depth: 800 mm							Material: copper Cross section: 50 x 10 x 1	Material: copper Cross section: 40 x 10 x 1		
Main busbar							SX busbar			
Current / A IP30	Current / A IP55	I _{cw} 1s / kA	I _{pk} / kA	Distance ph. to ph. / mm	Distance A support and enclosure / mm	Distance B support to support / mm	Current / A IP30 & IP55	Distance B support to support / mm	Current / A IP30 & IP55	Distance B support to support / mm
2000	2000	85	187	100	150	325				
2000	2000	75	165	100	150	325				
2000	2000	70	154	100	175	350				
2000	2000	65	143	100	175	375				
2000	2000	52	114.4	100	225	475	1000	250	800	250
2000	2000	40	84	100	300	625	1000	300	800	300
2000	2000	35	73.5	100	350	700	1000	300	800	300
2000	2000	30	63	100	400	825	1000	400	800	400
2000	2000	25	52.5	100	425	850	1000	400	800	400
2000	2000	15	30	100	425	850	1000	500	800	500

Copper busbar enclosure depth 800 mm - 2500 A

Material: copper Cross section: 100 x 10 x 1 Minimum enclosure depth: 800 mm							Material: copper Cross section: 120 x 10 x 1	Material: copper Cross section: 80 x 10 x 1		
Main busbar							SX busbar			
Current / A IP30	Current / A IP55	I _{cw} 1s / kA	I _{pk} / kA	Distance ph. to ph. / mm	Distance A support and enclosure / mm	Distance B support to support / mm	Current / A IP30 & IP55	Distance B support to support / mm	Current / A IP30 & IP55	Distance B support to support / mm
2500	2125	85	187	100	150	325	2000	250	1600	200
2500	2125	75	165	100	175	375	2000	250	1600	200
2500	2125	70	154	100	200	400	2000	250	1600	250
2500	2125	65	143	100	225	450	2000	300	1600	250
2500	2125	52	114.4	100	275	550	2000	400	1600	300
2500	2125	40	84	100	350	725	2000	400	1600	400
2500	2125	35	73.5	100	400	825	2000	400	1600	400
2500	2125	30	63	100	425	850	2000	500	1600	400
2500	2125	25	52.5	100	425	850	2000	500	1600	500
2500	2125	15	30	100	425	850	2000	500	1600	500

Copper busbar enclosure depth 800 mm - 2500 A

Material: copper Cross section: 100 x 10 x 2 Minimum enclosure depth: 800 mm							Material: copper Cross section: 50 x 10 x 1	Material: copper Cross section: 40 x 10 x 1		
Main busbar							SX busbar			
Current / A IP30	Current / A IP55	I _{cw} 1s / kA	I _{pk} / kA	Distance ph. to ph. / mm	Distance A support and enclosure / mm	Distance B support to support / mm	Current / A IP30 & IP55	Distance B support to support / mm	Current / A IP30 & IP55	Distance B support to support / mm
2500	2125	85	187	100	150	325				
2500	2125	75	165	100	175	375				
2500	2125	70	154	100	200	400				
2500	2125	65	143	100	225	450				
2500	2125	52	114.4	100	275	550	1000	250	800	250
2500	2125	40	84	100	350	725	1000	300	800	300
2500	2125	35	73.5	100	400	825	1000	3000	800	300
2500	2125	30	63	100	425	850	1000	400	800	400
2500	2125	25	52.5	100	425	850	1000	400	800	400
2500	2125	15	30	100	425	850	1000	500	800	500

Copper busbar enclosure depth 800 mm - 3200 A

Material: copper Cross section: 100 x 10 x 3 Minimum enclosure depth: 800 mm							Material: copper Cross section: 120 x 10 x 1	Material: copper Cross section: 80 x 10 x 1		
Main busbar							SX busbar			
Current / A IP30	Current / A IP55	Icw 1s / kA	Ipk / kA	Distance ph. to ph. / mm	Distance A support and enclosure / mm	Distance B support to support / mm	Current / A IP30 & IP55	Distance B support to support / mm	Current / A IP30 & IP55	Distance B support to support / mm
3200	2720	85	187	150	200	400	2000	200	1600	200
3200	2720	75	165	150	225	475	2000	250	1600	200
3200	2720	70	154	150	225	475	2000	250	1600	250
3200	2720	65	143	150	275	550	2000	300	1600	250
3200	2720	52	114.4	150	325	675	2000	400	1600	300
3200	2720	40	84	150	425	850	2000	400	1600	400
3200	2720	35	73.5	150	425	850	2000	400	1600	400
3200	2720	30	63	150	425	850	2000	500	1600	400
3200	2720	25	52.5	150	425	850	2000	500	1600	500
3200	2720	15	30	150	425	850	2000	500	1600	500

Copper busbar enclosure depth 800 mm - 3200 A

Material: copper Cross section: 100 x 10 x 3 Minimum enclosure depth: 800 mm							Material: copper Cross section: 50 x 10 x 1	Material: copper Cross section: 40 x 10 x 1		
Main busbar							SX busbar			
Current / A IP30	Current / A IP55	I _{cw} 1s / kA	I _{pk} / kA	Distance ph. to ph. / mm	Distance A support and enclosure / mm	Distance B support to support / mm	Current / A IP30 & IP55	Distance B support to support / mm	Current / A IP30 & IP55	Distance B support to support / mm
3200	2720	85	187	150	200	400				
3200	2720	75	165	150	225	475				
3200	2720	70	154	150	225	475				
3200	2720	65	143	150	275	550				
3200	2720	52	114.4	150	325	675	1000	250	800	250
3200	2720	40	84	150	425	850	1000	300	800	300
3200	2720	35	73.5	150	425	850	1000	300	800	300
3200	2720	30	63	150	425	850	1000	400	800	400
3200	2720	25	52.5	150	425	850	1000	400	800	400
3200	2720	15	30	150	425	850	1000	500	800	500

Copper busbar enclosure depth 800 mm - 4000 A

Material: copper Cross section: 120 x 10 x 3 Minimum enclosure depth: 800 mm							Material: copper Cross section: 120 x 10 x 1	Material: copper Cross section: 80 x 10 x 1		
Main busbar							SX busbar			
Current / A IP30	Current / A IP55	Icw 1s / kA	Ipk / kA	Distance ph. to ph. / mm	Distance A support and enclosure / mm	Distance B support to support / mm	Current / A IP30 & IP55	Distance B support to support / mm	Current / A IP30 & IP55	Distance B support to support / mm
4000	3400	85	187	150	200	400	2000	200	1600	200
4000	3400	75	165	150	250	525	2000	250	1600	200
4000	3400	70	154	150	275	575	2000	250	1600	250
4000	3400	65	143	150	300	625	2000	300	1600	250
4000	3400	52	114.4	150	375	775	2000	400	1600	300
4000	3400	40	84	150	425	850	2000	400	1600	400
4000	3400	35	73.5	150	425	850	2000	400	1600	400
4000	3400	30	63	150	425	850	2000	500	1600	400
4000	3400	25	52.5	150	425	850	2000	500	1600	500
4000	3400	15	30	150	425	850	2000	500	1600	500

Copper busbar enclosure depth 800 mm - 4000 A

Material: copper Cross section: 120 x 10 x 3 Minimum enclosure depth: 800 mm							Material: copper Cross section: 50 x 10 x 1	Material: copper Cross section: 40 x 10 x 1		
Main busbar							SX busbar			
Current / A IP30	Current / A IP55	I _{cw} 1s / kA	I _{pk} / kA	Distance ph. to ph. / mm	Distance A support and enclosure / mm	Distance B support to support / mm	Current / A IP30 & IP55	Distance B support to support / mm	Current / A IP30 & IP55	Distance B support to support / mm
4000	3400	85	187	150	200	400				
4000	3400	75	165	150	250	525				
4000	3400	70	154	150	275	575				
4000	3400	65	143	150	300	625				
4000	3400	52	114.4	150	375	775	1000	250	800	250
4000	3400	40	84	150	425	850	1000	300	800	300
4000	3400	35	73.5	150	425	850	1000	300	800	300
4000	3400	30	63	150	425	850	1000	400	800	400
4000	3400	25	52.5	150	425	850	1000	400	800	400
4000	3400	15	30	150	425	850	1000	500	800	500

3.4.4 Aluminium extruded busbar

Aluminium busbar selection for currents up to 1600 A

Aluminium busbars without holes

Installation		[A]	Up to 1600 A		
Permissible current* enclosure depth: 400 / 600 / 800 mm	IP30, IP31	[A]	800	1250	1600
	IP43, IP55	[A]	800	1250	1600
Size of bars		[mm]	50 x 18.5	60 x 18.5	100 x 18.5
Number of bars per phase			1	1	1

*) for an ambient temperature of 35 °C around the switchboard

Aluminium distribution busbars



Busbar support placement

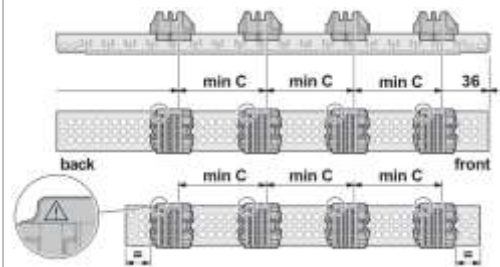
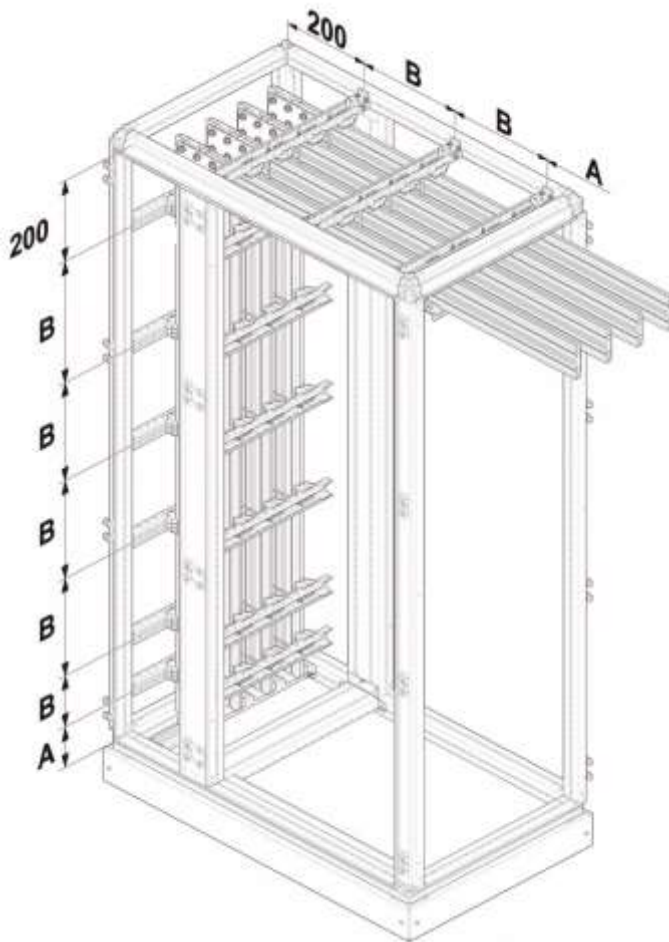

A	Distance between support and enclosure
B	Distance between supports
C	Phase-to-phase distance

NOTICE

Main busbar and secondary distribution busbar need to have the same phase-to-phase distance!

The busbars configurations presented in the next pages show a growing phase to phase distance with the depth of the enclosure.

It is possible to use the phase-to-phase distance of the depth 400 mm and mount the busbars in the enclosures of depth 600 mm and 800 mm in order to free up space at the rear of the cabinet.

3.4.4.1 Aluminium busbars, enclosure depth 400 mm - Technical data

Aluminium busbar enclosure depth 400 mm - 800 A

Material: aluminium Cross section: 50 x 18.5 x 1 Minimum enclosure depth: 400 mm							Material: aluminium Cross section: 50 x 18.5 x 1	
Main busbar							Secondary distribution busbar	
Current / A IP30	Current / A IP55	Icw 1s / kA	Ipk / kA	Distance C phase to phase / mm	Distance A support / mm	Distance B support / mm	Current / A IP30 & IP55	Distance B support / mm
800	800	40	84	70	150	300	800	300
800	800	35	73.5	70	150	300	800	300
800	800	30	63	70	150	300	800	300
800	800	25	52.5	70	150	300	800	300
800	800	15	30	70	150	300	800	300

Aluminium busbar enclosure depth 400 mm - 1250 A

Material: aluminium Cross section: 60 x 18.5 x 1 Minimum enclosure depth: 400 mm							Material: aluminium Cross section: 60 x 18.5 x 1		Material: aluminium Cross section: 50 x 18.5 x 1	
Main busbar							Secondary distribution busbar			
Current / A IP30	Current / A IP55	Icw 1s / kA	Ipk / kA	Distance C phase to phase / mm	Distance A support / mm	Distance B support / mm	Current / A IP30 & IP55	Distance B support / mm	Current / A IP30 & IP55	Distance B support / mm
1250	1250	52	114.4	70	150	300	1250	300	x	x
1250	1250	40	84	70	150	300	1250	300	800	300
1250	1250	35	73.5	70	150	300	1250	300	800	300
1250	1250	30	63	70	150	300	1250	300	800	300
1250	1250	25	52.5	70	150	300	1250	300	800	300
1250	1250	15	30	70	150	300	1250	300	800	300

Aluminium busbar enclosure depth 400 mm - 1600 A

Material: aluminium Cross section: 100 x 18.5 x 1 Minimum enclosure depth: 400 mm							Material: aluminium Cross section: 100 x 18.5 x 1	Material: aluminium Cross section: 60 x 18.5 x 1	Material: aluminium Cross section: 50 x 18.5 x 1			
Main busbar							Secondary distribution busbar					
Current / A IP30	Current / A IP55	I _{cw} 1s / kA	I _{pk} / kA	Distance C phase to phase / mm	Distance A support / mm	Distance B support / mm	Current / A IP30 & IP55	Distance B support / mm	Current / A IP30 & IP55	Distance B support / mm	Current / A IP30 & IP55	Distance B support / mm
1600	1600	70	154	70	125	250	1600	250	x	x	x	x
1600	1600	65	143	70	125	250	1600	250	x	x	x	x
1600	1600	52	114.4	70	125	250	1600	250	1250	300	x	x
1600	1600	40	84	70	125	250	1600	250	1250	300	800	300
1600	1600	35	73.5	70	125	250	1600	250	1250	300	800	300
1600	1600	30	63	70	125	250	1600	250	1250	300	800	300
1600	1600	25	52.5	70	125	250	1600	250	1250	300	800	300
1600	1600	15	30	70	125	250	1600	250	1250	300	800	300

3.4.4.2 Aluminium busbars, enclosure depth 600 mm - Technical data

Aluminium busbar enclosure depth 600 mm - 800 A

Material: aluminium Cross section: 50 x 18.5 x 1 Minimum enclosure depth: 600 mm							Material: aluminium Cross section: 50 x 18.5 x 1	
Main busbar							Secondary distribution busbar	
Current / A IP30	Current / A IP55	I _{cw} 1s / kA	I _{pk} / kA	Distance C phase to phase / mm	Distance A support / mm	Distance B support / mm	Current / A IP30 & IP55	Distance B support / mm
800	800	40	84	100	150	300	800	300
800	800	35	73.5	100	150	300	800	300
800	800	30	63	100	150	300	800	300
800	800	25	52.5	100	150	300	800	300
800	800	15	30	100	150	300	800	300

Aluminium busbar enclosure depth 600 mm - 1250 A

Material: aluminium Cross section: 60 x 18.5 x 1 Minimum enclosure depth: 600 mm							Material: aluminium Cross section: 60 x 18.5 x 1		Material: aluminium Cross section: 50 x 18.5 x 1	
Main busbar							Secondary distribution busbar			
Current / A IP30	Current / A IP55	I _{cw} 1s / kA	I _{pk} / kA	Distance C phase to phase / mm	Distance A support / mm	Distance B support / mm	Current / A IP30 & IP55	Distance B support / mm	Current / A IP30 & IP55	Distance B support / mm
1250	1250	52	114.4	100	150	300	1250	300	x	x
1250	1250	40	84	100	150	300	1250	300	800	300
1250	1250	35	73.5	100	150	300	1250	300	800	300
1250	1250	30	63	100	150	300	1250	300	800	300
1250	1250	25	52.5	100	150	300	1250	300	800	300
1250	1250	15	30	100	150	300	1250	300	800	300

Aluminium busbar enclosure depth 600 mm - 1600 A

Material: aluminium Cross section: 100 x 18.5 x 1 Minimum enclosure depth: 600 mm							Material: aluminium Cross section: 100 x 18.5 x 1	Material: aluminium Cross section: 60 x 18.5 x 1	Material: aluminium Cross section: 50 x 18.5 x 1			
Main busbar							Secondary distribution busbar					
Current / A IP30	Current / A IP55	I _{cw} 1s / kA	I _{pk} / kA	Distance C phase to phase / mm	Distance A support / mm	Distance B support / mm	Current / A IP30 & IP55	Distance B support / mm	Current / A IP30 & IP55	Distance B support / mm	Current / A IP30 & IP55	Distance B support / mm
1600	1600	70	154	100	125	250	1600	250	x	x	x	x
1600	1600	65	143	100	125	250	1600	250	x	x	x	x
1600	1600	52	114.4	100	125	250	1600	250	1250	300	x	x
1600	1600	40	84	100	125	250	1600	250	1250	300	800	300
1600	1600	35	73.5	100	125	250	1600	250	1250	300	800	300
1600	1600	30	63	100	125	250	1600	250	1250	300	800	300
1600	1600	25	52.5	100	125	250	1600	250	1250	300	800	300
1600	1600	15	30	100	125	250	1600	250	1250	300	800	300

3.4.4.3 Aluminium busbar and Service Index 223 & 233 - Technical data

Aluminium busbar enclosure depth 600 mm / 800 mm - 1600 A

Material: aluminium Cross section: 100 x 18.5 x 1 Minimum enclosure depth: 600 mm / 800 mm							Material: copper Cross section: 80 x 10 x 1		Material: copper Cross section: 50 x 10 x 1		Material: copper Cross section: 40 x 10 x 1	
Main busbar							SX busbar					
Current / A IP30	Current / A IP55	Icw 1s / kA	Ipk / kA	Distance C phase to phase / mm	Distance A support / mm	Distance B support / mm	Current / A IP30 & IP55	Distance B support / mm	Current / A IP30 & IP55	Distance B support / mm	Current / A IP30 & IP55	Distance B support / mm
1600	1600	70	154	100	125	250	1600	250	x	x	x	x
1600	1600	65	143	100	125	250	1600	250	x	x	x	x
1600	1600	52	114.4	100	125	250	1600	300	1000	250	800	250
1600	1600	40	84	100	125	250	1600	400	1000	300	800	300
1600	1600	35	73.5	100	125	250	1600	400	1000	300	800	300
1600	1600	30	63	100	125	250	1600	400	1000	400	800	400
1600	1600	25	52.5	100	125	250	1600	500	1000	400	800	400
1600	1600	15	30	100	125	250	1600	500	1000	500	800	500

3.4.5 Aluminium busbar accessories

Connection for flexibars & cables

- M8 hammerhead screws (held in place by spring-loaded ball), zinc plated steel
- 2 lengths for 5 mm / 10 mm thick copper
- Class: 8.8
- Torque: 20 Nm
- Supplied with M8 nut and anti vibration washer



UC9825S	Hammerhead screw, quadro.system M8 x 25 mm, 50Pz
UC9840S	Hammerhead screw, quadro.system M8 x 40 mm, 50Pz

⚠ WARNING

If the hammerhead of the hammerhead screw is not aligned correctly then the flexibar is not sufficiently affixed.

Risk of injury due to electric hazard, e.g. arc fault.

- Check that the hammerhead (T) screw is fully turned 90° and the screw engages in the Aluminium T-slot profile.



Connection of main and transfer aluminium busbar



1	UC9800C	Connection plate, quadro.system 800 A
2	UC9125C	Connection plate, quadro.system 1250 A
3	UC9160C	Connection plate, quadro.system 1600 A
4	UC9800T	Derivation plate, quadro.system 800 A
5	UC9125T	Derivation plate, quadro.system 1250 A

Connection between main copper and aluminium transfer busbar

In the case of derivation from main busbar in copper to a secondary distribution busbar in aluminium, take care to interconnect all bars used per phase to the aluminium profile. The spacers and connection parts needed can be produced according to the drawings provided under the indicated part number in the chart.

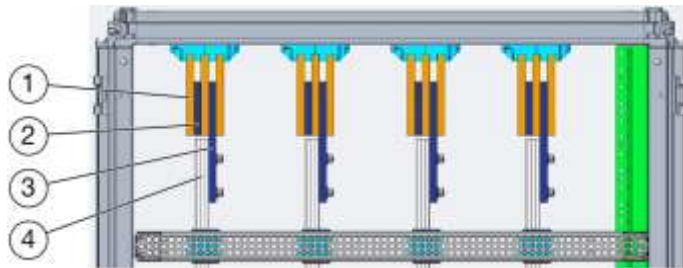

- | | |
|---|---|
| 1 | Copper (main busbar) |
| 2 | Spacer |
| 3 | Connection part |
| 4 | Aluminium (secondary distribution busbar) |

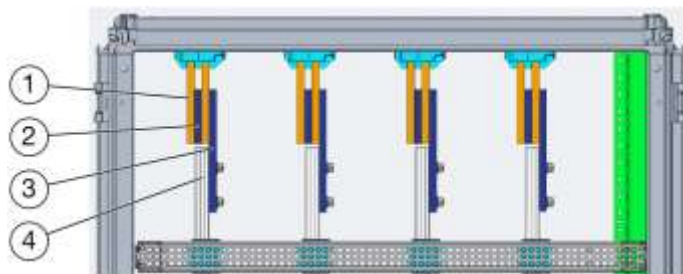

- | | |
|---|---|
| 1 | Copper (main busbar) |
| 2 | Spacer |
| 3 | Connection part |
| 4 | Aluminium (secondary distribution busbar) |

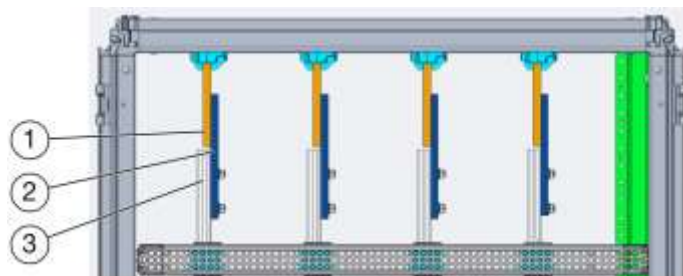

- | | |
|---|---|
| 1 | Copper (main busbar) |
| 2 | Connection part |
| 3 | Aluminium (secondary distribution busbar) |

Connection between copper and aluminium - 800 A

Material: copper						Material: aluminium Current: 800 A	
Main busbar						Secondary distribution busbar	
Current / A IP30	Enclosure depth	Current / A IP55	Cross section / mm	Max. I _{cw} 1s / kA	Max. I _{pk} / kA	Connection part (drawing number)	Spacer
500	400	500	50 x 5 x 1	40	84	UC9800C	No spacer needed
630	400	630	63 x 5 x 1	52	114.4	UC9800C	No spacer needed
800	400	800	80 x 5 x 1	65	143	UC9800C	No spacer needed
1000	400	1000	100 x 5 x 1	65	143	UC9800C	No spacer needed
1250	400	1250	80 x 10 x 1	85	187	7G8228000	No spacer needed
1600	400	1600	120 x 10 x 1	85	187	7G8228000	No spacer needed
630	600	630	63 x 5 x 1	52	114.4	UC9800C	No spacer needed
800	600	800	80 x 5 x 1	65	143	UC9800C	No spacer needed
1000	600	1000	100 x 5 x 1	70	154	UC9800C	No spacer needed
1250	600	1250	80 x 10 x 1	70	154	7G8228000	No spacer needed
1600	600	1600	120 x 10 x 1	70	154	7G8228000	No spacer needed
2000	800	1700	80 x 10 x 2	70	154	7G8228000	7G8229000
2500	800	2125	100 x 10 x 2	70	154	7G8228000	7G8229000
3200	800	2720	100 x 10 x 3	70	154	7G8228000	7G8229000
4000	800	3400	120 x 10 x 3	70	154	7G8228000	7G8229000

Connection between copper and aluminium - 1250 A

Material: copper						Material: aluminium Current: 1250 A	
Main busbar						Secondary distribution busbar	
Current / A IP30	Enclosure depth	Current / A IP55	Cross section / mm	Max. I _{cw} 1s / kA	Max. I _{pk} / kA	Connection part (drawing number)	Spacer
500	400	500	50 x 5 x 1	40	84	x	
630	400	630	63 x 5 x 1	52	114.4	x	
800	400	800	80 x 5 x 1	65	143	x	
1000	400	1000	100 x 5 x 1	65	143	x	
1250	400	1250	80 x 10 x 1	85	187	7G8226000	No spacer needed
1600	400	1600	120 x 10 x 1	85	187	7G8226000	No spacer needed
630	600	630	63 x 5 x 1	52	114.4	x	
800	600	800	80 x 5 x 1	65	143	x	
1000	600	1000	100 x 5 x 1	70	154	x	
1250	600	1250	80 x 10 x 1	70	154	7G8226000	No spacer needed
1600	600	1600	120 x 10 x 1	70	154	7G8226000	No spacer needed
2000	800	1700	80 x 10 x 2	70	154	7G8226000	7G8227000
2500	800	2125	100 x 10 x 2	70	154	7G8226000	7G8227000
3200	800	2720	100 x 10 x 3	70	154	7G8226000	7G8227000
4000	800	3400	120 x 10 x 3	70	154	7G8226000	7G8227000

Connection between copper and aluminium - 1600 A

Material: copper						Material: aluminium Current: 1600 A	
Main busbar						Secondary distribution busbar	
Current / A IP30	Enclosure depth	Current / A IP55	Cross section / mm	Max. I _{cw} 1s / kA	Max. I _{pk} / kA	Connection part (drawing number)	Spacer
500	400	500	50 x 5 x 1	40	84	x	
630	400	630	63 x 5 x 1	52	114.4	x	
800	400	800	80 x 5 x 1	65	143	x	
1000	400	1000	100 x 5 x 1	65	143	x	
1250	400	1250	80 x 10 x 1	85	187	x	
1600	400	1600	120 x 10 x 1	85	187	7G8224000	No spacer needed
630	600	630	63 x 5 x 1	52	114.4	x	
800	600	800	80 x 5 x 1	65	143	x	
1000	600	1000	100 x 5 x 1	70	154	x	
1250	600	1250	80 x 10 x 1	70	154	x	
1600	600	1600	120 x 10 x 1	70	154	7G8224000	No spacer needed
2000	800	1700	80 x 10 x 2	70	154	7G8224000	7G8225000
2500	800	2125	100 x 10 x 2	70	154	7G8224000	7G8225000
3200	800	2720	100 x 10 x 3	70	154	7G8224000	7G8225000
4000	800	3400	120 x 10 x 3	70	154	7G8224000	7G8225000

Connection between main and transfer copper busbar

No special connection part between horizontal and vertical busbar is needed;
Holes acc. rules in DIN 43673 (best practice).



3.5 Forms of internal separation

3.5.1 Separation parts

Internal separators (forms of separation)

Using internal separations or different forms of separation within the Power Switchgear and Controlgear Assembly (PSC), the switchboard can be divided up according to functions in closed, protected spaces with different objectives:

- Protecting persons and functional units* from direct contact with dangerous live parts, for which the protection rating must at least be equal to IP XXB***.
- Protecting equipment against the penetration of solid bodies; the protection rating must at least be equal to IP 2X** (contact protection IPXXB and IP2X are fulfilled if standard protection covers of quadro evo are used).
- Limiting as much as possible the effects of electric arc propagation.
- Facilitating and limiting the time required for maintenance operations on the switchboard.

Separations are made using barriers or partitions which must be fixed securely and have sufficient stability and durability to maintain the required protection ratings and the appropriate separation between live parts.

Each manufacturer is free to develop these separations in metal or insulating materials.

The main aim is to keep the electrical power available in the event of a fault or when working on the switchboard.

In table 104, international standard IEC / EN IEC 61439-2 defines the separations inside an assembly according to 4 types of form from 1 to 4, which are subdivided into two groups a and b.

* Functional unit: part of an assembly containing the mechanical and electrical components, including connecting devices, contributing to the performance of a single function.

** IP2 X: protects persons from access to dangerous parts with their fingers, and protects equipment inside the enclosure from solid bodies of $\varnothing \geq 12.5$ mm.

*** IP XXB: protects against insertion of fingers. The articulated test finger of $\varnothing 12$ mm and 80 mm long must remain at a sufficient distance from the dangerous parts.

In case of main busbar located in the top or in the bottom of the enclosure, it can be separated by a full size horizontal panel against other equipment.



Segregation horizontal full, 300x400	UC3040FUH
Segregation horizontal full, 300x600	UC3060FUH
Segregation horizontal full, 300x800	UC3080FUH
Segregation horizontal full, 350x400	UC3540FUH
Segregation horizontal full, 350x600	UC3560FUH
Segregation horizontal full, 350x800	UC3580FUH
Segregation horizontal full, 600x400	UC6040FUH
Segregation horizontal full, 600x600	UC6060FUH
Segregation horizontal full, 600x800	UC6080FUH
Segregation horizontal full, 800x400	UC8040FUH
Segregation horizontal full, 800x600	UC8060FUH
Segregation horizontal full, 800x800	UC8080FUH

To separate devices from each other, mounted on standard system kits, additional horizontal segregations are needed.

In case only front connection of devices is used, only the front part of the segregation is needed.



Segregation frontal horizontal, L350	UC350FH
Segregation frontal horizontal, L600	UC600FH
Segregation frontal horizontal, L800	UC800FH

In case of rear connection of devices, additionally the rear part of horizontal segregation is needed. Alternatively a full size segregation may be used.



Segregation back horizontal, 350x400	UC3540BH
Segregation back horizontal, 350x600	UC3560BH
Segregation back horizontal, 350x800	UC3580BH
Segregation back horizontal, 600x400	UC6040BH
Segregation back horizontal, 600x600	UC6060BH
Segregation back horizontal, 600x800	UC6080BH
Segregation back horizontal, 800x400	UC8040BH
Segregation back horizontal, 800x600	UC8060BH
Segregation back horizontal, 800x800	UC8080BH

In case of main busbar located vertically on one side of the enclosure, it can be separated by a vertical panel against other equipment.

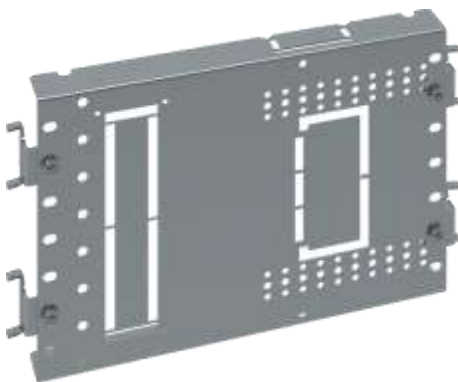

Segregation lateral full, 100x400	UC1040FUL
Segregation lateral full, 100x600	UC1060FUL
Segregation lateral full, 100x800	UC1080FUL
Segregation lateral full, 150x400	UC1540FUL
Segregation lateral full, 150x600	UC1560FUL
Segregation lateral full, 150x800	UC1580FUL
Segregation lateral full, 200x400	UC2040FUL
Segregation lateral full, 200x600	UC2060FUL
Segregation lateral full, 200x800	UC2080FUL
Segregation lateral full, 300x400	UC3040FUL
Segregation lateral full, 300x600	UC3060FUL
Segregation lateral full, 300x800	UC3080FUL
Segregation lateral full, 400x400	UC4040FUL
Segregation lateral full, 400x600	UC4060FUL
Segregation lateral full, 400x800	UC4080FUL
Segregation lateral full, 600x400	UC6040FUL
Segregation lateral full, 600x600	UC6060FUL
Segregation lateral full, 600x800	UC6080FUL

In case only front connection of devices is used, only the front part of the segregation is needed.

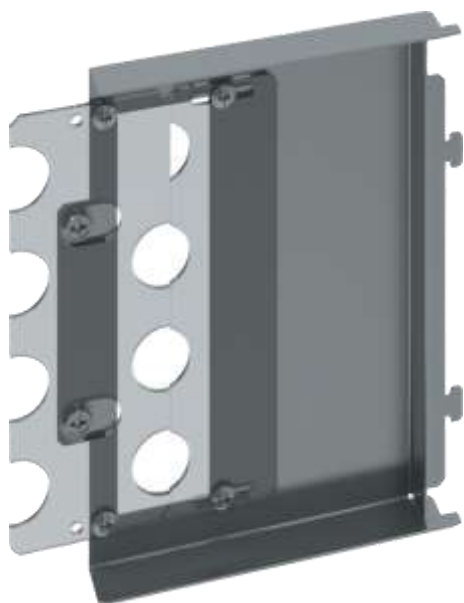

Segregation frontal lateral, H150	UC150FL
Segregation frontal lateral, H200	UC200FL
Segregation frontal lateral, H300	UC300FL
Segregation frontal lateral, H400	UC400FL
Segregation frontal lateral, H600	UC600FL

In case of rear connection of devices, additionally the rear part of segregation is needed. Alternatively a full size segregation may be used.

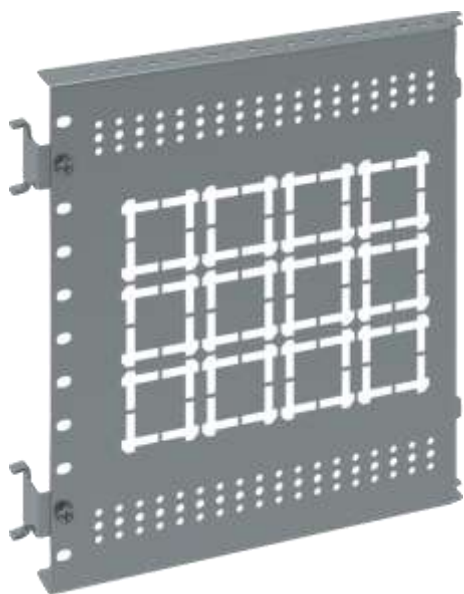

Segregation back lateral, 150x400	UC1540BL
Segregation back lateral, 150x600	UC1560BL
Segregation back lateral, 150x800	UC1560BL
Segregation back lateral, 200x400	UC2040BL
Segregation back lateral, 200x600	UC2060BL
Segregation back lateral, 200x800	UC2080BL
Segregation back lateral, 300x400	UC3040BL
Segregation back lateral, 300x600	UC3060BL
Segregation back lateral, 300x800	UC3080BL
Segregation back lateral, 400x400	UC4040BL
Segregation back lateral, 400x600	UC4060BL
Segregation back lateral, 400x800	UC4080BL
Segregation back lateral, 600x400	UC6040BL
Segregation back lateral, 600x600	UC6060BL
Segregation back lateral, 600x800	UC6080BL

If only few rows of modular devices need to be installed in the incoming compartment, the most economic solution to separate them from other parts of the assembly is using a UC*FMD housing.



Kit for segregation modular devices 600x150	UC6015FMD
Kit for segregation modular devices 600x200	UC6020FMD
Kit for segregation modular devices 800x150	UC8015FMD
Kit for segregation modular devices 800x200	UC8020FMD

If the terminals of the MCCB type H1600 need to be separated from each other, for Form 4, an additional horizontal panel is needed.



Segregation back horizontal 1250/1600A	UC1600BH
Segregation back horizontal 800/1000A	UC1000BH

To ensure touch protection against incoming terminals when front cover is removed, the MCCB type H1600 needs an additional vertical panel.

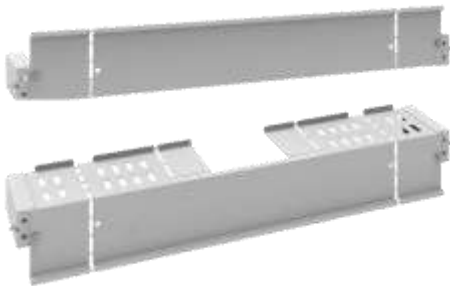

Segregation vertical 1250/1600A	UC1600V
Segregation vertical 800/1000A	UC1000V

All Forms of segregation for the ACB can be achieved with the housings included in this kit.



segregation plate ACB HW 600x600 mm	UC6060HW
segregation plate ACB HW 600x800 mm	UC6080HW
segregation plate ACB HWT 600x600 mm	UC6060HWT
segregation plate ACB HWT 600x800 mm	UC608040HWT
segregation plate ACB HWT 600x800 mm	UC6080HWT

To ensure the segregation of the incoming cables when side / rear panels are removed, additional vertical panels are needed.

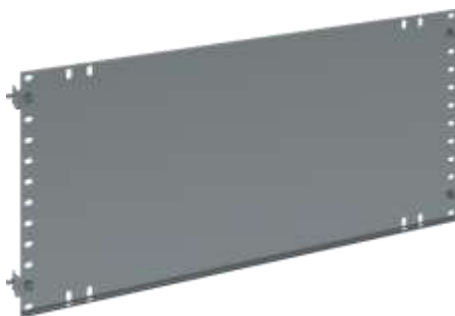

Segregation vertical, 350x200	UC3520V
Segregation vertical, 600x150	UC6015V
Segregation vertical, 600x200	UC6020V
Segregation vertical, 600x300	UC6030V
Segregation vertical, 600x400	UC6040V
Segregation vertical, 600x600	UC6060V
Segregation vertical, 800x150	UC8015V
Segregation vertical, 800x200	UC8020V
Segregation vertical, 800x300	UC8030V
Segregation vertical, 800x400	UC8040V
Segregation vertical, 800x600	UC8060V

To separate outgoing terminals of MCCBs for Form 4, small housings can be added in the cable compartment.



Downstream 4B connection box, H200	UC200CB
Downstream 4B connection box, H300	UC300CB

In case front and rear connections of devices are used in a mix, corner segregations are needed.



Segregation back corner, H200	UC200C
Segregation back corner, H300	UC300C

To ensure segregation of MCCB kits against rear access, some applications may require UC*VD covers.

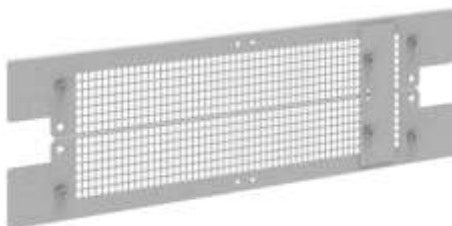

Segregation vertical, W350 drilled	UC350VD
Segregation vertical, W700 drilled	UC600VD
Segregation vertical, W900 drilled	UC800VD

Form 1

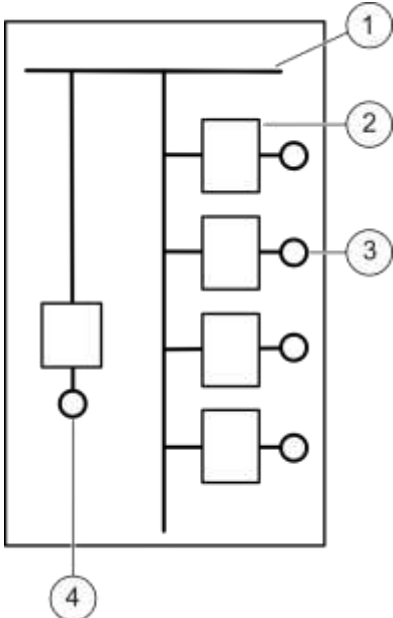

1	Busbars
2	Output unit
3	Terminals for external conductors
4	Input unit

No internal separation

Form 2

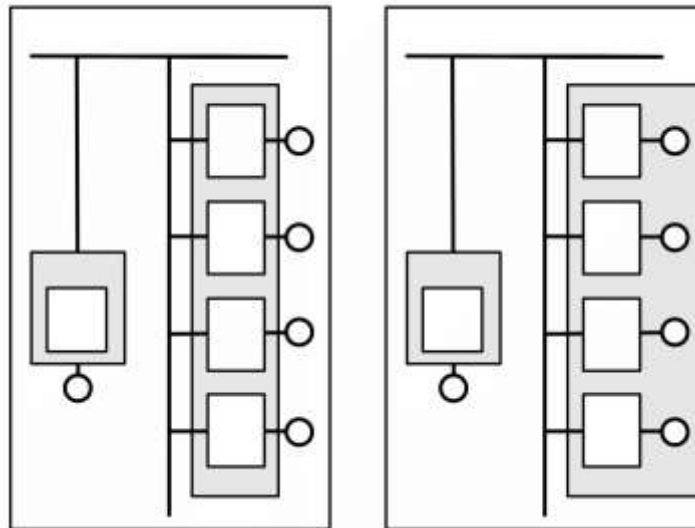

Form 2a

Form 2b

Form 2a

- Separation between busbars and all the functional units.
- The terminals for external conductors are not separated from the busbars.

Form 2b

- Separation between busbars and all the functional units.
- The terminals for external conductors are separated from the busbars.

Incoming device

Incoming device is segregated by metal partitions to provide maximum protection during maintenance or equipment substitution.

There is partitioning available for three-pole and four-pole equipment.

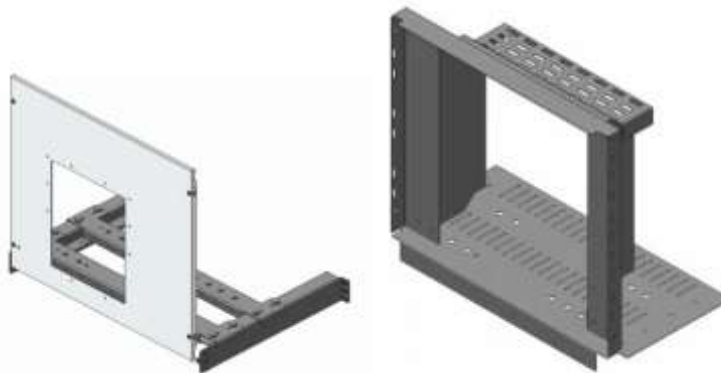

Example of partitioning for ACB (air circuit breaker).

Busbars

To produce a Form 2b in a quadro evo cabinet, both main and distribution busbars must be physically separated from the terminals upstream and downstream of the switchgear.

Our offer includes vertical and horizontal partitions that are fixed to the cabinet structure to provide:

- IPXXB protecting rating,
- protection of persons,
- separation of the busbars from the functional units.

To avoid all risk of direct contact during maintenance, we recommend equipping the upstream terminals of moulded case circuit breakers with terminal covers.

Horizontal partitions

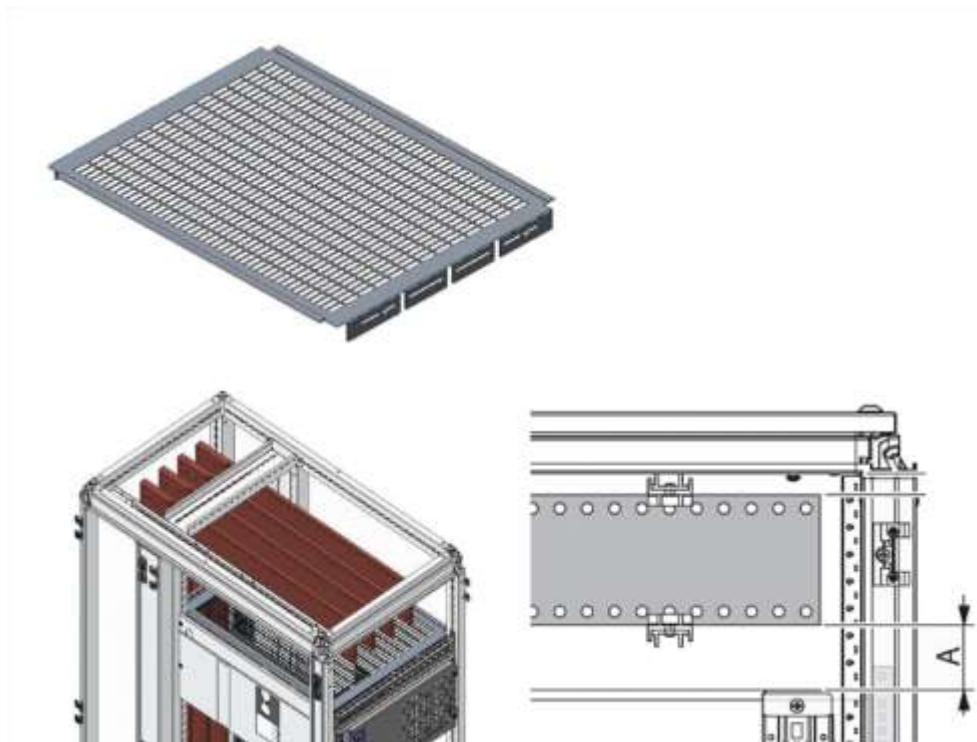

To ensure maximum safety in the event of a short circuit on the busbars, the horizontal partition must be at least 50 mm (side A) from the busbars.

This distance of 50 mm should also be observed to separate the horizontal connection of the service entrance equipment from the main busbar.

Vertical partitions

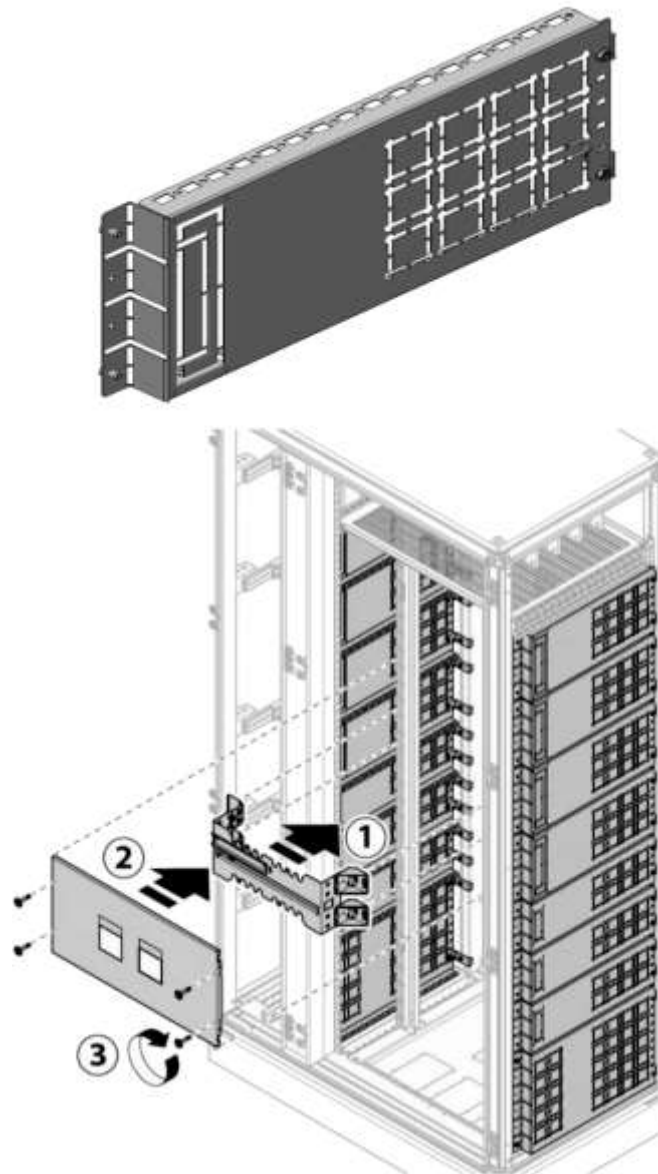

The height of the vertical partition must be minimum the height of the equipment kit.

Modular form segregation

In case modular devices need to be installed in the incoming cell in combination with ACBs, a special cover can be used to fulfil the separation of the DIN module from busbars.

Sizes for 700 mm and 900 mm enclosures are available.

The height of the kit is 150 or 200 mm.

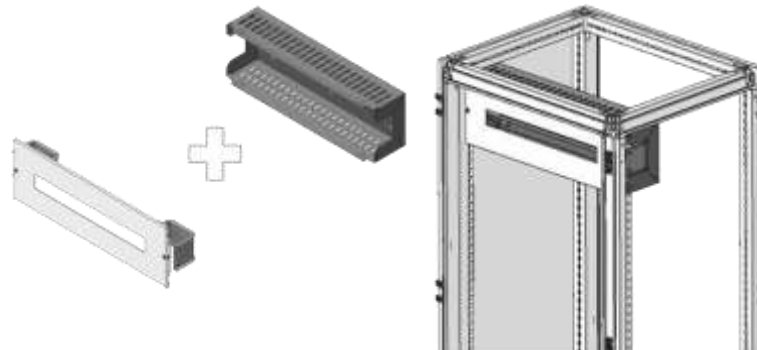

Kit for modular devices, DIN rail, 150x350	UC1530MD
Kit for modular devices, DIN rail, 150x600	UC1560MD
Kit for modular devices, DIN rail, 150x800	UC1580MD
Kit for modular devices, DIN rail, 200x600	UC2060MD
Kit for modular devices, DIN rail, 200x800	UC2080MD
Kit for modular devices, adjustable DIN rail, 200x350	UC2035AMD
Kit for modular devices, adjustable DIN rail, 200x600	UC2060AMD
Kit for modular devices, adjustable DIN rail, 200x800	UC2080AMD
Segregation for modular devices DIN rail 600x150	UC6015FMD
Segregation for modular devices DIN rail 800x150	UC8015FMD
Segregation for modular devices DIN rail 600x200	UC6020FMD
Segregation for modular devices DIN rail 800x200	UC8020FMD

Form 3

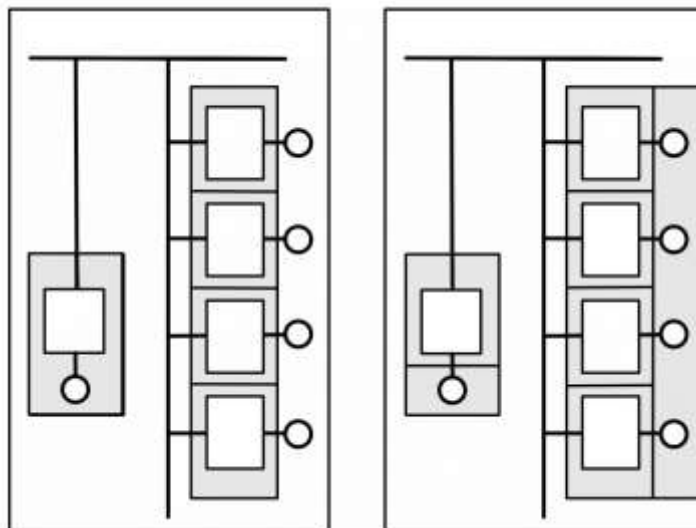

Form 3a

Form 3b

Form 3a

- Separation between busbars and all the functional units.
- Separation of all functional units from one another
- The terminals for external conductors are not separated from the busbars.

Form 3b

- Separation between busbars and all the functional units.
- Separation of all functional units from one another
- The terminals for external conductors are separated from the busbars.

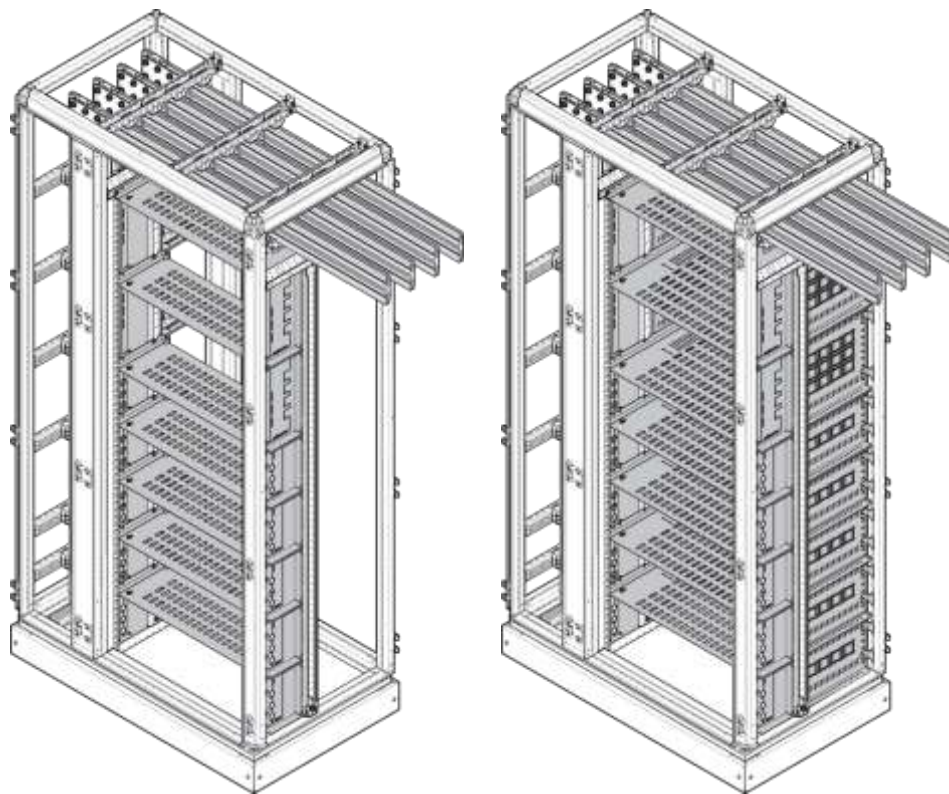
Segregation to Form 3

Segregation to Form 3 of MCCBs is done by the standard horizontal segregation plates, installed between each MCCB kit. Take into consideration the connection type of the device, front or rear. Rear connections need a full segregation, also behind the kit's mounting plate.

Form 4

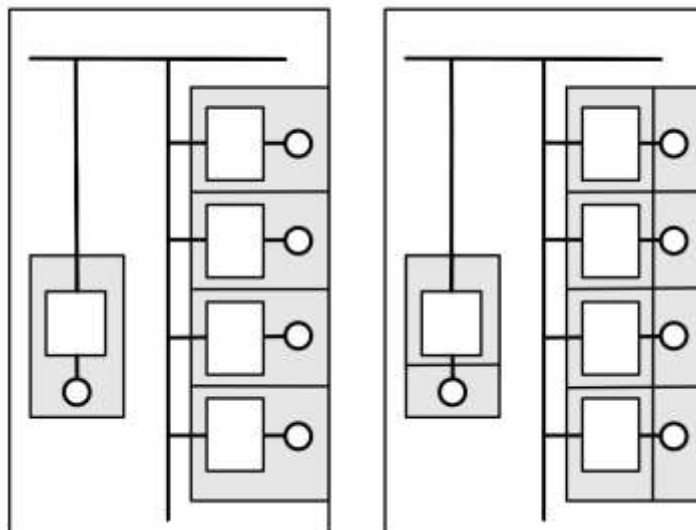

Form 4a

Form 4b

Form 4a

- Separation of busbars from all functional units.
- Separation of all functional units from one another
- Separation of all external conductors from the busbar.
- No separation of all external conductors from the related functional unit.
- The terminals for external conductors are separated from the busbars.
- Separation of all terminals for external conductors from one another.

Form 4b

- Separation of busbars from all functional units.
- Separation of all functional units from one another.
- Separation of all external conductors from the busbar.
- Separation of all external conductors from the functional units.
- The terminals for external conductors are separated from the busbars.
- Separation of all terminals for external conductors from one another.

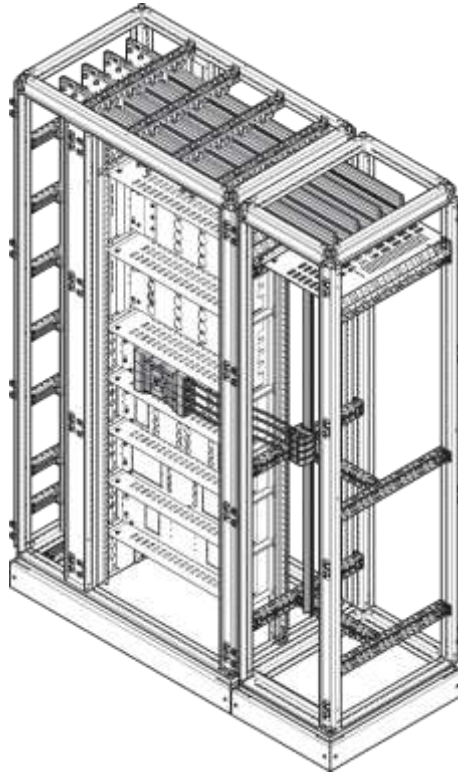
Segregation to Form 4

Segregation to Form 4 of MCCBs is done by standard lateral segregation plates, installed between each MCCB and the cable compartment, to ensure the separation of incoming and outgoing terminals. Terminals have to be separated from each other by additional barriers in the cable compartment.

3.6 Types of functional units



3.6.1 Mobility index

Types of functional units connections

The electrical connections of the functional units in the assemblies can be denoted by a combination of three letters forming the mobility index:

- the first letter denotes the type of electrical connection of the main incoming circuit (upstream),
- the second letter denotes the type of electrical connection in the main feed circuit (downstream),
- the third letter denotes the type of electrical connection in the auxiliary circuits.

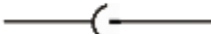
The following letters must be used:

Letter	Type of connection	Symbol	Selection control
F	Fixed: - bolted connection, requires a tool for connection		No
D	Disconnectable: - connection that is connected or disconnected by hand without a tool		No
W	Withdrawable: - connection that is connected or disconnected by placing the functional unit in the connected or isolated position while it remains mechanically connected to the cabinet		Yes

3.6.2 Service index

The right level of service continuity

All organisations have certain demands regarding continuous availability of electricity because it is a basic requirement for lasting success and economic viability.

The degree of availability needed has to be defined for any application as this allows optimization of the electrical installation.

Even a short interruption may cause serious consequences if, for example, subsequent processes are impaired. Therefore, Hager has invested significant effort to achieve a high level of continuous availability.

Service continuity solutions for operation, maintenance and evolution

All offered solutions by Hager comply with standards IEC / EN IEC 61439-1 / -2.

By implementing the quadro evo system, you ensure that all components are fully compatible with each other.

To guarantee safety, Hager solutions with switchgear mounted on plug-in bases, withdrawable chassis and disconnectable or withdrawable mounting plates include safety trip levers (to order separately) which cause the circuit breaker to interrupt the circuit when the component is removed.

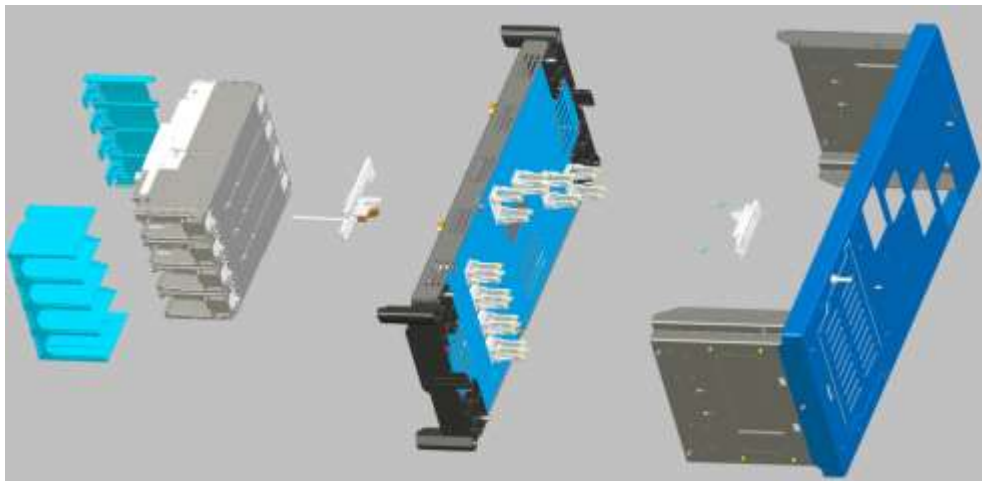

Maximum degree of service continuity

Functional units with devices mounted on mounting plates allowing live changes

Disconnectable solution IS223:

- Conformity with IEC / EN IEC 61439-2 (DFF)
- High power availability
- 1 hour maximum permissible outage time for maintenance
- Upgrading possible without power disconnection

Functional units with devices mounted on mounting plates allowing live retraction

Disconnectable solution IS233:

- Conformity with IEC / EN IEC 61439-2 (DDD)
- High power availability
- 15 min maximum permissible outage time for maintenance
- Upgrading possible without power disconnection

3.6.3 Service index ratings

Service ratings

Service ratings are defined in the guide UTE C 63-429.

The purpose of the guide is to prepare an agreement between the user (end customer, design office, etc.) and the manufacturer on the simple and precise requirements concerning operational continuity, maintenance or upgrading of the installation.

The service rating (SR) is a three-digit code corresponding to operational, maintenance and upgrade.

Each criterion is given a score from 1 to 3. A score of 1 is for the poorest service and a score of 3 is for the best.

The guide applies to high power assemblies defined by international standards IEC / EN IEC 61439-1 / -2 "Low-voltage switchgear and controlgear assemblies".

The three-digit principle

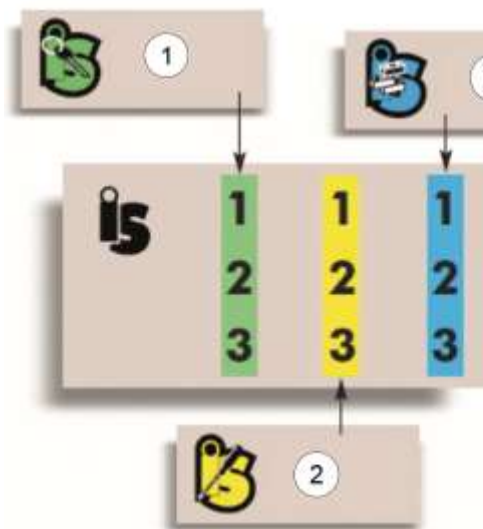

The first digit (first column in green) "Operation" determines the consequences of a mechanical or electrical lockout on the switchboard.

The second digit "Maintenance" determines the ability of the switchboard to respond to a maintenance requirement.

The last column "Upgrade" determines the ability of the switchboard to respond to a maintenance requirement.

1	Operation of the switchboard
2	Maintenance of the switchboard
3	Evolution of the switchboard

The meaning of the Service Index three digits

	Operation	Maintenance	Upgrade
1	General isolation and lock-out of the assembly. Not possible to individually lock out functional units. Complete shutdown of the switchboard.	General isolation and lock-out of the assembly. Complete shutdown of the switchboard for an indefinite period.	General isolation and lock-out of the assembly. Complete shutdown of the switchboard for an indefinite period.
2	Individual isolation and lockout of the FUs.	Individual isolation and lockout of the FUs. Intervention on connections required to replace FU.	Predetermined upgrades (power and technology), agreed during the design phase, are possible without general isolation of the switchboard. FUs are added in an equipped location in the fixed part, defined by the manufacturer and the user.
3	Individual isolation and lockout of the FUs. Auxiliary circuits can be tried (in particular automated operations), with the power circuits off-load.	Individual isolation and lockout of the FUs. No intervention required on connections to replace FU.	Predetermined upgrades (power and technology), agreed during the design phase, are possible without general isolation of the switchboard.

3.6.4 Service Index ratings of internal system

Functional units needed per Service Index

The service index is a characteristic of the functional units of low-voltage switchboards. It describes the level of requirements in terms of operation, maintenance and evolution of the system.

The fitting system parts and type of device must be chosen according to the required index service.

Index service rating	Form of segregation	Mobility index	Type of kit	Type of device
111	1	FFF	quadro evo	all
112	2b	FFF	plug-in	P160, P250, P630, ACB
113	2b	DFF	SX kit	P160, P250, P630
121	3b	DFF	plug-in	P160, P250, P630, ACB
122	3b	DFF	plug-in	P160, P250, P630, ACB
123	3b	DFF	SX kit	P160, P250, P630
131	3b	DDD	plug-in	P160, P250, P630, ACB
132	3b	DDD	plug-in	P160, P250, P630, ACB
133	3b	DDD	SX kit	P160, P250, P630
211	1	FFF	quadro evo	all
212	2b	DFF	plug-in	P160, P250, P630, ACB
213	2b	DFF	SX kit	P160, P250, P630
221	3b	DFF	plug-in	P160, P250, P630, ACB
222	3b	DFF	plug-in	P160, P250, P630, ACB
223	3b	DFF	SX kit	P160, P250, P630
231	3b	DDD	plug-in	P160, P250, P630, ACB
232	3b	DDD	plug-in	P160, P250, P630, ACB
233	3b	DDD	SX kit	P160, P250, P630
311	1	WWW	draw-out	P250, P630, ACB
312	2b	WWW	draw-out	P250, P630, ACB
313	3b	WWW	draw-out	solution unavailable
321	3b	WWW	draw-out	P250, P630, ACB
322	3b	WWW	draw-out	P250, P630, ACB
323	3b	WWW	draw-out	solution unavailable
331	3b	WWW	draw-out	P250, P630, ACB
332	3b	WWW	draw-out	P250, P630, ACB
333	3b	WWW	draw-out	solution unavailable

3.6.5 Dedicated parts for Service Index 223 / 233

Enclosures configuration

The compartment for the configurations of service index levels IS223 and IS233 requires a dedicated internal equipment named SX.



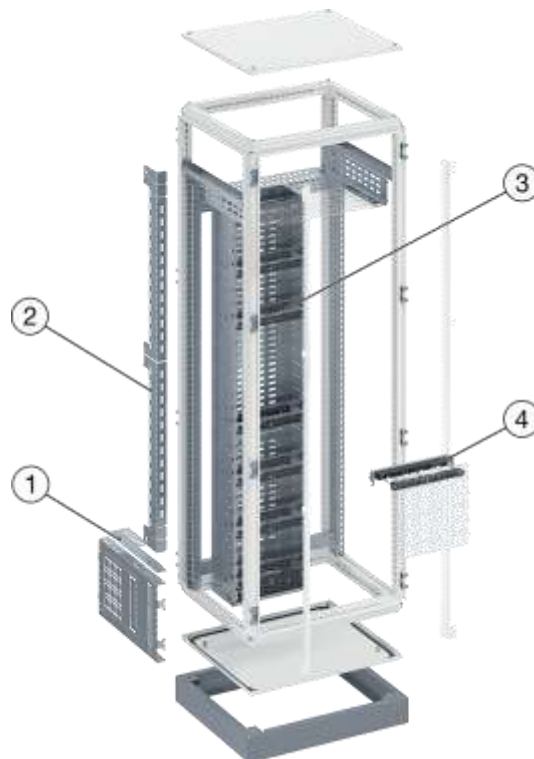

The vertical copper busbar in the rear can supply up to I_{nA} 2000 A for outgoing circuits. The application is limited to P160, P250 and P630 or x630 versions of MCCBs, size 630 A maximum.

The devices have to be installed on dedicated functional units that are plugged into the vertical distribution busbar. The contact tulips are designed in such a way that the spring does not relax over a very long period of time, thus guaranteeing constant contact forces. In addition, the components are galvanically silver-plated so that the surfaces have a very reliable low contact impedance.

The grease on the contact tulips is only there to reduce the sliding forces (especially for the P400 & P630 switches with 2 contact tulips per phase). It does not fulfil any electrical function. Therefore, there is no need to add grease during maintenance, the initially applied grease spreads evenly over the contact surface during the first mating and forms a lubricating film that remains present during further mating operations. The quality and elasticity of the electrical 'tulip' contacts is a technology proven by their usage in other Hager systems for many years.

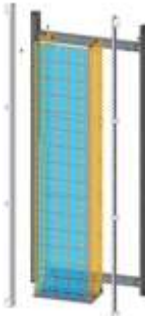

1	Extension space segregation for busbar
2	Vertical busbar segregation
3	Structure & distribution kit
4	Distribution busbar support

Enclosure dimensions	D600		D800		Content	
	H1900	H2100	H1900	H2100		
Enclosure width [mm]	1000 + 450 700 + 450	1000 + 450 700 + 450	1000 + 450 700 + 450	1000 + 450 700 + 450	- standard enclosure frame	
Structure & distribution kit	UCSX1860ST	UCSX2060ST	UCSX160ST	UCSX2060SR	<ul style="list-style-type: none"> - front upright - back upright & horizontal distribution busbar fixation bracket - distribution busbar side panels - front segregation - bottom panel & rear segregation, 1 x plastic busbar support - (front cover H300 for main busbar space) 	
Distribution busbar support	UCSX600BB				<ul style="list-style-type: none"> - 2 x plastic support - 2 x distribution busbar support brackets - distribution busbar rail - screws 	
Vertical busbar segregation	UCSX6060FV		UCSX6080FV		- 2 x segregation plate	
Extension space segregation for busbar	UCSX600PL				- 1 x segregation plate	

Functional unit kits (mobile part)

These are the mobile parts that can be moved and plugged into the busbar. There are two options, IS223 version can only be plugged into the incoming terminals, while IS233 can also be plugged into the outgoing terminals.

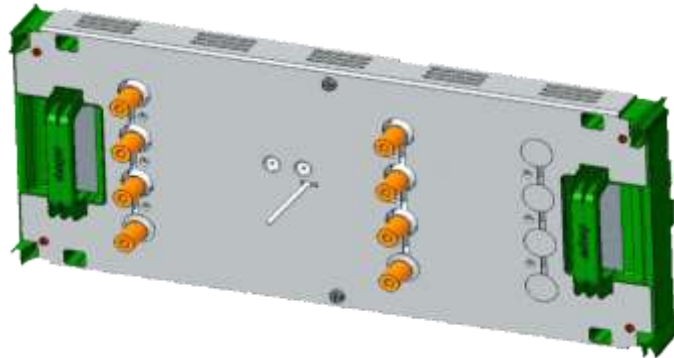

The MCCB shall be pre-installed on the functional unit.

Device		without RCD		with RCD			
		IS223	IS233	IS223	IS233		
P160	3P	UCSX161A3	UCSX161B3				
	4P	UCSX161A4	UCSX161B4				
P250	3P	UCSX262A3	UCSX262B3				UCSX262B3R
	4P	UCSX262A4	UCSX262B4				UCSX262B4R
P630 or x630	3P	UCSX463A3	UCSX463B3				UCSX463B3R
	4P	UCSX463A4	UCSX463B4				UCSX463B4R

Backbox kits (fix part)

The backbox needs to be fixed in front of the busbar, in the position where the corresponding MCCB will be placed. It provides the segregations required for IS223 / IS233 and the fixation materials for the moveable part.

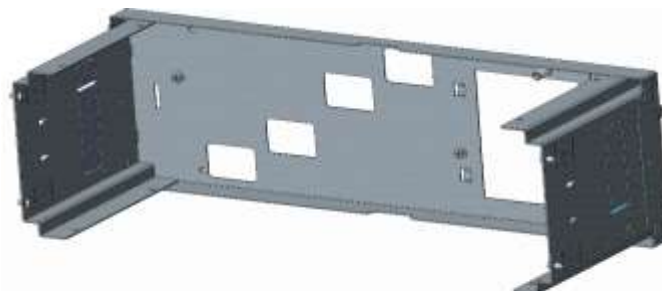

Device		
P160	H150	UCSX1560BK
P240	H200	UCSX2060BK
P630	H250	UCSX3060BK

IS233 downstream connection box

For service index level IS233, this additional adapter is required on the outgoing terminals that have to be plugged in also.

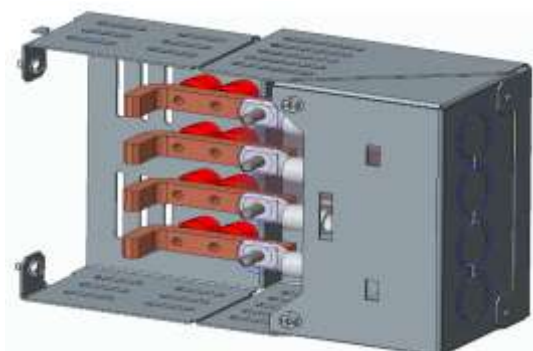

Device		3P	4P
P160	H150	UCSX150B3P	UCSX150B4P
P240	H200	UCSX200B3P	UCSX200B4P
P630	H250	UCSX300B3P	UCSX200B4P

Front covers

For forms of segregation above Form 3, the front covers are required to separate the devices from each other once the door is opened. That's why those front covers are not included as default in the reference of the functional unit kit.

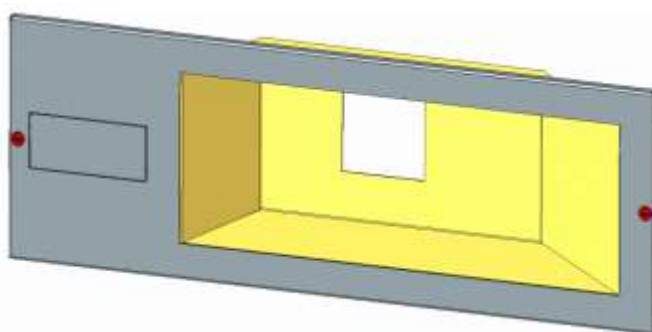

Device		Type of command		
		Direct command	Rotary handle	Motor command
P160	with RCD			
	without RCD	UCSX161D	UCSX161R	
P250	with RCD	UCSX262DR	UCSX262RR	UCSX262MR
	without RCD			
P630 or x630	with RCD	UCSX463DR	UCSX463RR	UCSX463MR
	without RCD			

Accessory

To ensure IP protection for cables and flexibars, the accessory listed below is provided. It is to be installed in the lateral segregation plates.

Plastic lateral segregation for kits H250	UCSX150FL
Plastic lateral segregation for kits H200	UCSX200FL
Plastic lateral segregation for kits H250	UCSX300FL

For segregation Form 3, horizontal segregations are required to be installed between the MCCBs.

Horizontal segregation plate	UCSX600FH
------------------------------	-----------

It is possible to install modular devices such as lamps or meters next to the functional unit. To do so, a special accessory adapter fixed in the side of the functional unit is used.

Modular device adapter (6M)	UCSXMT
-----------------------------	--------

In case of a gap to laterally attached compartments needs to be closed, to ensure IP2X segregation, additional pre-fitted parts can be ordered

vertical busbar segregation 600 mm deep	UCSX6060FV
vertical busbar segregation 800 mm deep	UCSX6080FV
extension space segregation for busbar	UCSX600PL

For auxiliary plug-in terminals we recommend to use Wago accessory such as:

Spring half	
6 poles:	231-106/026-000
8 poles:	231-108/026-000

Pin half:	
6 poles:	231-606/019-000
8 poles:	231-608/019-000

3.7 Functional units

3.7.1 Circuit breaker kit product codes

Product codes

See below for summary tables of mounting kits for circuit breaker integration in enclosures.

The kit widths shown are for the usable internal width of the enclosure, (W - 100 mm).

For example, a 450 mm enclosure requires a kit width of 450 - 100 = 350 mm.

MCCB Code summary

UC	2	6	4	PN
Series	I _n	Modular width	Modular height	Type

	Series	I _n	Modular width		Modular height		Type		
h3+	UC	1	160 A	3	350	2	200	PN	Fix
		2	250 A	6	600	3	300	PRN	Fix+ Rcd
				8	800	4	400	PIN	Mechanical Interlock
								PMN	Motorized
								PDN	Multiple
								PWN	Draw-Out
								PPN	Plug-in

h3+	UC	4	630 A	3	350	3	300	P	P Version	N	Fix
				6	600	4	400	X	X Version	RN	Fix+ Rcd
				8	800	6	600			IN	Mechanical Interlock
										MN	Motorized
										DN	Multiple
										WN	Draw-Out
										PN	Plug-in

h3	UC	1	630 A	3	350	3	300	P	X Version		Fix
		2	250 A	6	600	4	400	X	H Version	R	Fix+ Rcd
		4	630 A	8	800	6	600	X-H	X and H Version	M	Motorized
		5	1000 A							D	Multiple
		6	1600 A								

3.7.2 MCCB (Moulded Case Circuit Breaker)

Installation options

There are several system kits options available to install the same type of device in the assembly.

The kit's reference code to be selected depends on:

- fixation method of the device
 - fixed
 - plug-in
 - draw-out
- orientation of the device
 - horizontal mounting
 - vertical mounting
- operation of device
 - direct drive / rotary handle / external handle
 - interlocking mechanism
 - motor drive
- size of the board
- quantity of devices to be installed

3.7.2.1 System kits references for fixation of MCCBs in the enclosure.

MCCB P160 - vertical

In		25 A - 160 A				
Orientation		Vertical				
Poles		3 / 4				
Type of device		P160 MCCB				
Type of kit		Fix (op. rotary & ext. handle)				
Reference		UC133PN	UC163PN*	UC183PN*		
						
No. of devices per kit		1	3	4		
Height x width of kit [mm]		300 x 350	300 x 600	300 x 800		
Class II accessory		UC000XHP				
Segregation Form 2b	Lateral segregation front	full size	UC300FL			
	Lateral segregation back	Enclosure depth [mm]	400	UC3040BL		
			600	UC3060BL		
			800	UC3080BL		
	Lateral segregation full depth	Enclosure depth [mm]	400	UC3040FUL		
			600	UC3060FUL		
			800	UC3080FUL		
	Horizontal top / bottom full depth	Enclosure depth [mm]	400	UC3540FUH	UC6040FUH	UC8040FUH
			600	UC3560FUH	UC6060FUH	UC8060FUH
			800	UC3580FUH	UC6080FUH	UC8080FUH
Segregation Form 3b	Horizontal top / bottom front	full size	UC350FH	UC600FH	UC800FH	
	Horizontal top / bottom back	Enclosure depth [mm]	400	UC3540BH	UC6040BH	UC8040BH
			600	UC3560BH	UC6060BH	UC8060BH
			800	UC3580BH	UC6080BH	UC8080BH
	Horizontal top / bottom full depth	Enclosure depth [mm]	400	UC3540FUH	UC6040FUH	UC8040FUH
			600	UC3560FUH	UC6060FUH	UC8060FUH
			800	UC3580FUH	UC6080FUH	UC8080FUH
Rear vertical	full size	N.A.	UC6030V	UC8030V		
Segregation Form 4b	Terminal covers (front connection)	3 poles	HYS021H			
		4 poles	HYS022H			
	Terminal blocks	Phases	KXB70LH			
		Neutral	KXB70NH			
	Segregation (rear connection)	In and out	N.A.	N.A.	N.A.	
In or out		N.A.	N.A.	N.A.		

* Note: In case of more than 1 device per kit, the maximum reachable form of segregation is 2b.

MCCB P160 - vertical

	In	25 A - 160 A			
	Orientation	Vertical			
	Poles	3 / 4			
	Type of device	P160 MCCB			
	Type of kit	Plug-in			
	Reference	UC163PPN*	UC183PPN*		
					
	No. of devices per kit	2	3		
	Height x width of kit [mm]	300 x 600	300 x 800		
	Class II accessory	UC000XHP			
Segregation Form 2b	Lateral segregation front	full size	UC300FL		
	Lateral segregation back	Enclosure depth [mm]	400	UC3040BL	
		600	UC3060BL		
		800	UC3080BL		
	Lateral segregation full depth	Enclosure depth [mm]	400	UC3040FUL	
		600	UC3060FUL		
		800	UC3080FUL		
	Horizontal top / bottom full depth	Enclosure depth [mm]	400	UC6040FUH	UC8040FUH
		600	UC6060FUH	UC8060FUH	
		800	UC6080FUH	UC8080FUH	
Segregation Form 3b	Horizontal top / bottom front	full size	UC600FH	UC800FH	
	Horizontal top / bottom back	Enclosure depth [mm]	400	UC6040BH	UC8040BH
		600	UC6060BH	UC8060BH	
		800	UC6080BH	UC8080BH	
	Horizontal top / bottom full depth	Enclosure depth [mm]	400	UC6040FUH	UC8040FUH
		600	UC6060FUH	UC8060FUH	
		800	UC6080FUH	UC8080FUH	
Rear vertical	full size	UC6030V	UC8030V		
Segregation Form 4b	Terminal covers (front connection)	3 poles	HYS021H		
		4 poles	HYS022H		
	Terminal blocks	Phases	KXB70LH		
		Neutral	KXB70NH		
	Segregation (rear connection)	In and out	N.A.	N.A.	
In or out		N.A.	N.A.		

* Note: In case of more than 1 device per kit, the maximum reachable form of segregation is 2b.

MCCB P160 - vertical

	In		25 A - 160 A		
	Orientation		Vertical		
	Poles		3 / 4		
	Type of device		P160 MCCB		
	Type of kit		Fixed; mechanical interlock		
	Reference		UC163PIN*	UC183PIN*	
	No. of devices per kit		2	3	
	Height x width of kit [mm]		300 x 600	300 x 800	
	Class II accessory		UC000XHP		
Segregation Form 2b	Lateral segregation front	full size	UC300FL		
	Lateral segregation back	Enclosure depth [mm]	400	UC3040BL	
			600	UC3060BL	
			800	UC3080BL	
	Lateral segregation full depth	Enclosure depth [mm]	400	UC3040FUL	
			600	UC3060FUL	
			800	UC3080FUL	
	Horizontal top / bottom full depth	Enclosure depth [mm]	400	N.A.	N.A.
			600	N.A.	N.A.
			800	N.A.	N.A.
Segregation Form 3b	Horizontal top / bottom front	full size	N.A.	N.A.	
	Horizontal top / bottom back	Enclosure depth [mm]	400	N.A.	N.A.
			600	N.A.	N.A.
			800	N.A.	N.A.
	Horizontal top / bottom full depth	Enclosure depth [mm]	400	N.A.	N.A.
			600	N.A.	N.A.
			800	N.A.	N.A.
Rear vertical	full size	N.A.	N.A.		
Segregation Form 4b	Terminal covers (front connection)	3 poles	N.A.		
		4 poles	N.A.		
	Terminal blocks	Phases	N.A.		
		Neutral	N.A.		
	Segregation (rear connection)	In and out	N.A.	N.A.	
		In or out	N.A.	N.A.	

* Note: In case of more than 1 device per kit, the maximum reachable form of segregation is 2b.

MCCB P160 - horizontal

	In	25 A - 160 A				
	Orientation	Horizontal				
	Poles	3 / 4				
	Type of device	P160 MCCB				
	Type of kit	Fix (op. rotary & ext. handle)				
	Reference	UC162PN	UC182PN	UC162PPN		
						
	No. of devices per kit	1	1	1		
	Height x width of kit [mm]	200 x 600	200 x 800	200 x 600		
	Class II accessory	UC000XHP				
Segregation Form 2b	Lateral segregation front	full size	UC200FL			
	Lateral segregation back	Enclosure depth [mm]	400	UC2040BL		
			600	UC2060BL		
			800	UC2080BL		
	Lateral segregation full depth	Enclosure depth [mm]	400	UC2040FUL		
			600	UC2060FUL		
			800	UC2080FUL		
	Horizontal top / bottom full depth	Enclosure depth [mm]	400	UC6040FUH	UC8040FUH	UC6040FUH
			600	UC6060FUH	UC8060FUH	UC6060FUH
			800	UC6080FUH	UC8080FUH	UC6080FUH
Segregation Form 3b	Horizontal top / bottom front	full size	UC600FH	UC800FH	UC600FH	
	Horizontal top / bottom back	Enclosure depth [mm]	400	UC6040BH	UC8040BH	UC6040BH
			600	UC6060BH	UC8060BH	UC6060BH
			800	UC6080BH	UC8080BH	UC6080BH
	Horizontal top / bottom full depth	Enclosure depth [mm]	400	UC6040FUH	UC8040FUH	UC6040FUH
			600	UC6060FUH	UC8060FUH	UC6060FUH
			800	UC6080FUH	UC8080FUH	UC6080FUH
Rear vertical	full size	UC6020V	UC6030V	UC8030V		
Segregation Form 4b	Terminal covers (front connection)	3 poles	HYS021H			
		4 poles	HYS022H			
	Terminal blocks	Phases	KXB70LH			
		Neutral	KXB70NH			
	Segregation (rear connection)	In and out	UC200C	UC200C	N.A.	
In or out		UC600VD	UC800VD	N.A.		

MCCB X160 - vertical

	In	16 A - 160 A				
	Orientation	Vertical				
	Poles	3 / 4				
	Type of device	X160 MCCB				
	Type of kit	Fix (op. rotary & ext. handle)				
	Reference	UC133X*	UC163X*	UC183X*		
						
	No. of devices per kit	2 (3P / 4P)	5 (3P) / 4 (4P)	8 (3P) / 6 (4P)		
	Height x width of kit [mm]	300 x 350	300 x 600	300 x 800		
	Class II accessory	UC000XHP				
Segregation Form 2b	Lateral segregation front	full size	UC300FL			
	Lateral segregation back	Enclosure depth [mm]	400	UC3040BL		
			600	UC3060BL		
			800	UC3080BL		
	Lateral segregation full depth	Enclosure depth [mm]	400	UC3040FUL		
			600	UC3060FUL		
			800	UC3080FUL		
	Horizontal top / bottom full depth	Enclosure depth [mm]	400	UC3540FUH	UC6040FUH	UC8040FUH
			600	UC3560FUH	UC6060FUH	UC8060FUH
			800	UC3580FUH	UC6080FUH	UC8080FUH
Segregation Form 3b	Horizontal top / bottom front	full size	UC350FH	UC600FH	UC800FH	
	Horizontal top / bottom back	Enclosure depth [mm]	400	UC3540BH	UC6040BH	UC8040BH
			600	UC3560BH	UC6060BH	UC8060BH
			800	UC3580BH	UC6080BH	UC8080BH
	Horizontal top / bottom full depth	Enclosure depth [mm]	400	UC3540FUH	UC6040FUH	UC8040FUH
			600	UC3560FUH	UC6060FUH	UC8060FUH
			800	UC3580FUH	UC6080FUH	UC8080FUH
Rear vertical	full size	N.A.	UC6030V	UC8030V		
Segregation Form 4b	Terminal covers (front connection)	3 poles	HYS021H			
		4 poles	HYS022H			
	Terminal blocks	Phases	KXB70LH			
		Neutral	KXB70NH			
	Segregation (rear connection)	In and out	N.A.	N.A.	N.A.	
In or out		N.A.	N.A.	N.A.		

* Note: In case of more than 1 device per kit, the maximum reachable form of segregation is 2b.

MCCB X160 - vertical

	In		16 A - 160 A		
	Orientation		Vertical		
	Poles		3 / 4		
	Type of device		X160 MCCB		
	Type of kit		N.A.		
	Reference	UC162XD*	UC182XD*		
	No. of devices per kit	5 (3P) / 4 (4P)	8 (3P) / 6 (4P)		
	Height x width of kit [mm]	200 x 600	200 x 800		
	Class II accessory	N.A.			
Segregation Form 2b	Lateral segregation front	full size	UC200FL		
	Lateral segregation back	Enclosure depth [mm]	400	UC2040BL	
			600	UC2060BL	
			800	UC2080BL	
	Lateral segregation full depth	Enclosure depth [mm]	400	UC2040FUL	
			600	UC2060FUL	
			800	UC2080FUL	
	Horizontal top / bottom full depth	Enclosure depth [mm]	400	UC6040FUH	UC8040FUH
			600	UC6060FUH	UC8060FUH
			800	UC6080FUH	UC8080FUH
Segregation Form 3b	Horizontal top / bottom front	full size	N.A.	N.A.	
	Horizontal top / bottom back	Enclosure depth [mm]	400	N.A.	N.A.
			600	N.A.	N.A.
			800	N.A.	N.A.
	Horizontal top / bottom full depth	Enclosure depth [mm]	400	N.A.	N.A.
			600	N.A.	N.A.
			800	N.A.	N.A.
Rear vertical	full size	N.A.	N.A.		
Segregation Form 4b	Terminal covers (front connection)	3 poles	N.A.		
		4 poles	N.A.		
	Terminal blocks	Phases	N.A.		
		Neutral	N.A.		
	Segregation (rear connection)	In and out	N.A.	N.A.	
		In or out	N.A.	N.A.	

MCCB X160 - horizontal

	In		16 A - 160 A	
	Orientation		Horizontal	
	Poles		3 / 4	
	Type of device		X160 MCCB	
	Type of kit		Fix (op. rotary & ext. handle)	
	Reference		UC162X	
				
	No. of devices per kit		1	
	Height x width of kit [mm]		200 x 600	
	Class II accessory		UC000XHP	
Segregation Form 2b	Lateral segregation front	full size	UC200FL	
	Lateral segregation back	Enclosure depth [mm]	400	UC2040BL
			600	UC2060BL
			800	UC2080BL
	Lateral segregation full depth	Enclosure depth [mm]	400	UC2040FUL
			600	UC2060FUL
			800	UC2080FUL
	Horizontal top / bottom full depth	Enclosure depth [mm]	400	UC6040FUH
			600	UC6060FUH
			800	UC6080FUH
	Segregation Form 3b	Horizontal top / bottom front	full size	UC600FH
		Horizontal top / bottom back	Enclosure depth [mm]	400
600				UC6060BH
800				UC6080BH
Horizontal top / bottom full depth		Enclosure depth [mm]	400	UC6040FUH
			600	UC6060FUH
			800	UC6080FUH
Rear vertical	full size	UC6020V		
Segregation Form 4b	Terminal covers (front connection)	3 poles	HYS021H	
		4 poles	HYS022H	
	Terminal blocks	Phases	KXB70LH	
		Neutral	KXB70NH	
	Segregation (rear connection)	In and out	UC200C	
		In or out	UC600VD	

MCCB P250 - vertical

	In	40 A - 250 A				
	Orientation	Vertical				
	Poles	3 / 4				
	Type of device	P250 MCCB				
	Type of kit	Fix (op. rotary & ext. handle)				
	Reference	UC233PN	UC263PN*	UC283PN*		
						
	No. of devices per kit	1	2	3		
	Height x width of kit [mm]	300 x 350	300 x 600	300 x 800		
	Class II accessory	UC000XHP				
Segregation Form 2b	Lateral segregation front	full size	UC300FL			
	Lateral segregation back	Enclosure depth [mm]	400	UC3040BL		
			600	UC3060BL		
			800	UC3080BL		
	Lateral segregation full depth	Enclosure depth [mm]	400	UC3040FUL		
			600	UC3060FUL		
			800	UC3080FUL		
	Horizontal top / bottom full depth	Enclosure depth [mm]	400	UC3540FUH	UC6040FUH	UC8040FUH
			600	UC3560FUH	UC6060FUH	UC8060FUH
			800	UC3580FUH	UC6080FUH	UC8080FUH
Segregation Form 3b	Horizontal top / bottom front	full size	UC350FH	UC600FH	UC800FH	
	Horizontal top / bottom back	Enclosure depth [mm]	400	UC3540BH	UC6040BH	UC8040BH
			600	UC3560BH	UC6060BH	UC8060BH
			800	UC3580BH	UC6080BH	UC8080BH
	Horizontal top / bottom full depth	Enclosure depth [mm]	400	UC3540FUH	UC6040FUH	UC8040FUH
			600	UC3560FUH	UC6060FUH	UC8060FUH
			800	UC3580FUH	UC6080FUH	UC8080FUH
Rear vertical	full size	N.A.	UC6030V	UC8030V		
Segregation Form 4b	Terminal covers (front connection)	3 poles	HYT021H			
		4 poles	HYT022H			
	Terminal blocks	Phases	KX150NH			
		Neutral	KXB150LH			
	Segregation (rear connection)	In and out	N.A.	N.A.	N.A.	
		In or out	N.A.	N.A.	N.A.	

* Note: In case of more than 1 device per kit, the maximum reachable form of segregation is 2b.

MCCB P250 - vertical

	In	40 A - 250 A		
	Orientation	Vertical		
	Poles	3 / 4		
	Type of device	P250 MCCB		
	Type of kit	Fix (op. rotary & ext. handle)		
	Reference	UC234PRN	UC264PRN*	
				
	No. of devices per kit	1	2	
	Height x width of kit [mm]	400 x 350	400 x 600	
	Class II accessory	UC000XHP		
Segregation Form 2b	Lateral segregation front	full size	UC400FL	
	Lateral segregation back	Enclosure depth [mm] 400	UC4040BL	
		600	UC4060BL	
		800	UC4080BL	
	Lateral segregation full depth	Enclosure depth [mm] 400	UC4040FUL	
		600	UC4060FUL	
		800	UC4080FUL	
	Horizontal top / bottom full depth	Enclosure depth [mm] 400	UC3540FUH	UC6040FUH
		600	UC3560FUH	UC6060FUH
		800	UC3580FUH	UC6080FUH
Segregation Form 3b	Horizontal top / bottom front	full size	UC350FH	UC600FH
	Horizontal top / bottom back	Enclosure depth [mm] 400	UC3540BH	UC6040BH
		600	UC3560BH	UC6060BH
		800	UC3580BH	UC6080BH
	Horizontal top / bottom full depth	Enclosure depth [mm] 400	UC3540FUH	UC6040FUH
		600	UC3560FUH	UC6060FUH
		800	UC3580FUH	UC6080FUH
Rear vertical	full size	N.A.	UC6030V	
Segregation Form 4b	Terminal covers (front connection)	3 poles	HYT021H	
		4 poles	HYT022H	
	Terminal blocks	Phases	KX150NH	
		Neutral	KXB150LH	
	Segregation (rear connection)	In and out	N.A.	N.A.
In or out		N.A.	N.A.	

* Note: In case of more than 1 device per kit, the maximum reachable form of segregation is 2b.

MCCB P250 - vertical

	In	40 A - 250 A			
	Orientation	Vertical			
	Poles	3 / 4			
	Type of device	P250 MCCB			
	Type of kit	Plug-in			
	Reference	UC263PPN*	UC283PPN*		
	No. of devices per kit	2	3		
	Height x width of kit [mm]	300 x 600	300 x 800		
	Class II accessory	UC000XHP			
Segregation Form 2b	Lateral segregation front	full size	UC300FL		
	Lateral segregation back	Enclosure depth [mm]	400	UC3040BL	
			600	UC3060BL	
			800	UC3080BL	
	Lateral segregation full depth	Enclosure depth [mm]	400	UC3040FUL	
			600	UC3060FUL	
			800	UC3080FUL	
	Horizontal top / bottom full depth	Enclosure depth [mm]	400	UC6040FUH	UC8040FUH
			600	UC6060FUH	UC8060FUH
			800	UC6080FUH	UC8080FUH
Segregation Form 3b	Horizontal top / bottom front	full size	UC600FH	UC800FH	
	Horizontal top / bottom back	Enclosure depth [mm]	400	UC6040BH	UC8040BH
			600	UC6060BH	UC8060BH
			800	UC6080BH	UC8080BH
	Horizontal top / bottom full depth	Enclosure depth [mm]	400	UC6040FUH	UC8040FUH
			600	UC6060FUH	UC8060FUH
			800	UC6080FUH	UC8080FUH
Rear vertical	full size	UC6030V	UC8030V		
Segregation Form 4b	Terminal covers (front connection)	3 poles	HYT021H		
		4 poles	HYT022H		
	Terminal blocks	Phases	KX150NH		
		Neutral	KXB150LH		
	Segregation (rear connection)	In and out	N.A.	N.A.	
In or out		N.A.	N.A.		

* Note: In case of more than 1 device per kit, the maximum reachable form of segregation is 2b.

MCCB P250 - vertical

In		40 A - 250 A				
Orientation		Vertical				
Poles		3 / 4				
Type of device		P250 MCCB				
Type of kit		Draw-out				
Reference		UC233PWN	UC263PWN*	UC283PWN*		
No. of devices per kit		1	1	2		
Height x width of kit [mm]		300 x 350	300 x 600	300 x 800		
Class II accessory		UC000XHP				
Segregation Form 2b	Lateral segregation front	full size	UC300FL			
	Lateral segregation back	Enclosure depth [mm]	400	UC3040BL		
			600	UC3060BL		
			800	UC3080BL		
	Lateral segregation full depth	Enclosure depth [mm]	400	UC3040FUL		
			600	UC3060FUL		
			800	UC3080FUL		
	Horizontal top / bottom full depth	Enclosure depth [mm]	400	UC3540FUH	UC6040FUH	UC8040FUH
			600	UC3560FUH	UC6060FUH	UC8060FUH
			800	UC3580FUH	UC6080FUH	UC8080FUH
Segregation Form 3b	Horizontal top / bottom front	full size	UC350FH	UC600FH	UC800FH	
	Horizontal top / bottom back	Enclosure depth [mm]	400	UC3540BH	UC6040BH	UC8040BH
			600	UC3560BH	UC6060BH	UC8060BH
			800	UC3580BH	UC6080BH	UC8080BH
	Horizontal top / bottom full depth	Enclosure depth [mm]	400	UC3540FUH	UC6040FUH	UC8040FUH
			600	UC3560FUH	UC6060FUH	UC8060FUH
			800	UC3580FUH	UC6080FUH	UC8080FUH
Rear vertical	full size	N.A.	UC6030V	UC8030V		
Segregation Form 4b	Terminal covers (front connection)	3 poles	HYT021H			
		4 poles	HYT022H			
	Terminal blocks	Phases	KX150NH			
		Neutral	KXB150LH			
	Segregation (rear connection)	In and out	N.A.	N.A.	N.A.	
In or out		N.A.	N.A.	N.A.		

* Note: In case of more than 1 device per kit, the maximum reachable form of segregation is 2b.

MCCB P250 - vertical

	In			40 A - 250 A	
	Orientation			Vertical	
	Poles			3 / 4	
	Type of device			P250 MCCB	
	Type of kit			Fixed; mechanical interlock	
	Reference			UC263PIN*	UC283PIN*
	No. of devices per kit			2	3
	Height x width of kit [mm]			300 x 600	300 x 800
	Class II accessory			UC000XHP	
Segregation Form 2b	Lateral segregation front	full size		UC300FL	
	Lateral segregation back	Enclosure depth [mm]	400	UC3040BL	
			600	UC3060BL	
			800	UC3080BL	
	Lateral segregation full depth	Enclosure depth [mm]	400	UC3040FUL	
			600	UC3060FUL	
			800	UC3080FUL	
	Horizontal top / bottom full depth	Enclosure depth [mm]	400	N.A.	N.A.
			600	N.A.	N.A.
			800	N.A.	N.A.
Segregation Form 3b	Horizontal top / bottom front	full size		N.A.	N.A.
	Horizontal top / bottom back	Enclosure depth [mm]	400	N.A.	N.A.
			600	N.A.	N.A.
			800	N.A.	N.A.
	Horizontal top / bottom full depth	Enclosure depth [mm]	400	N.A.	N.A.
			600	N.A.	N.A.
			800	N.A.	N.A.
Rear vertical	full size		N.A.	N.A.	
Segregation Form 4b	Terminal covers (front connection)	3 poles	N.A.		
		4 poles	N.A.		
	Terminal blocks	Phases	N.A.		
		Neutral	N.A.		
	Segregation (rear connection)	In and out	N.A.	N.A.	
		In or out	N.A.	N.A.	

* Note: In case of more than 1 device per kit, the maximum reachable form of segregation is 2b.

MCCB P250 - vertical

	In	40 A - 250 A				
	Orientation	Vertical				
	Poles	3 / 4				
	Type of device	P250 MCCB				
	Type of kit	Motorized		Multiple		
	Reference	UC263PMN*	UC283PMN*	UC263PDN*		
						
	No. of devices per kit	2	3	3		
	Height x width of kit [mm]	300 x 600	300 x 800	300 x 600		
	Class II accessory	UC000XHP		N.A.		
Segregation Form 2b	Lateral segregation front	full size	UC300FL			
	Lateral segregation back	Enclosure depth [mm]	400	UC3040BL		
			600	UC3060BL		
			800	UC3080BL		
	Lateral segregation full depth	Enclosure depth [mm]	400	UC3040FUL		
			600	UC3060FUL		
			800	UC3080FUL		
	Horizontal top / bottom full depth	Enclosure depth [mm]	400	UC6040FUH	UC8040FUH	N.A.
			600	UC6060FUH	UC8060FUH	N.A.
800			UC6080FUH	UC8080FUH	N.A.	
Segregation Form 3b	Horizontal top / bottom front	full size	UC600FH	UC800FH	N.A.	
	Horizontal top / bottom back	Enclosure depth [mm]	400	UC6040BH	UC8040BH	N.A.
			600	UC6060BH	UC8060BH	N.A.
			800	UC6080BH	UC8080BH	N.A.
	Horizontal top / bottom full depth	Enclosure depth [mm]	400	UC6040FUH	UC8040FUH	N.A.
			600	UC6060FUH	UC8060FUH	N.A.
			800	UC6080FUH	UC8080FUH	N.A.
Rear vertical	full size	UC6030V	UC8030V	N.A.		
Segregation Form 4b	Terminal covers (front connection)	3 poles	HYT021H		N.A.	
		4 poles	HYT022H		N.A.	
	Terminal blocks	Phases	KX150NH		N.A.	
		Neutral	KXB150LH		N.A.	
	Segregation (rear connection)	In and out	N.A.	N.A.	UC300C	
		In or out	N.A.	N.A.	UC600VD	

* Note: In case of more than 1 device per kit, the maximum reachable form of segregation is 2b.

MCCB P250 - horizontal

	In		40 A - 250 A	
	Orientation		Horizontal	
	Poles		3 / 4	
	Type of device		P250 MCCB	
	Type of kit		Fix (op. rotary & ext. handle) + RCD	
	Reference	UC262PRN	UC282PRN	
				
	No. of devices per kit	1	1	
	Height x width of kit [mm]	200 x 600	200 x 800	
	Class II accessory	UC000XHP		
Segregation Form 2b	Lateral segregation front	full size	UC200FL	
	Lateral segregation back	Enclosure depth [mm] 400	UC2040BL	
		600	UC2060BL	
		800	UC2080BL	
	Lateral segregation full depth	Enclosure depth [mm] 400	UC2040FUL	
		600	UC2060FUL	
		800	UC2080FUL	
	Horizontal top / bottom full depth	Enclosure depth [mm] 400	UC600FH	UC800FH
		600	UC6040BH	UC8040BH
		800	UC6060BH	UC8060BH
Segregation Form 3b	Horizontal top / bottom front	full size	UC6080BH	UC8080BH
	Horizontal top / bottom back	Enclosure depth [mm] 400	UC6040FUH	UC8040FUH
		600	UC6060FUH	UC8060FUH
		800	UC6080FUH	UC8080FUH
	Horizontal top / bottom full depth	Enclosure depth [mm] 400	UC3540FUH	UC6040FUH
		600	UC3560FUH	UC6060FUH
		800	UC3580FUH	UC6080FUH
Rear vertical	full size	UC6020V		
Segregation Form 4b	Terminal covers (front connection)	3 poles	HYT021H	
		4 poles	HYT022H	
	Terminal blocks	Phases	KX150NH	
		Neutral	KXB150LH	
	Segregation (rear connection)	In and out	UC200C	UC200C
In or out		UC600VD	UC800VD	

MCCB P250 - horizontal

	In		40 A - 250 A	
	Orientation		Horizontal	
	Poles		3 / 4	
	Type of device		P250 MCCB	
	Type of kit	Plug-in	Draw-out	
	Reference	UC262PPN	UC262PWN	
	No. of devices per kit	1	1	
	Height x width of kit [mm]	200 x 600	200 x 800	
	Class II accessory		UC000XHP	
Segregation Form 2b	Lateral segregation front	full size	UC200FL	
	Lateral segregation back	Enclosure depth [mm]	400	UC2040BL
			600	UC2060BL
			800	UC2080BL
	Lateral segregation full depth	Enclosure depth [mm]	400	UC6040FUH
			600	UC6060FUH
			800	UC6080FUH
	Horizontal top / bottom full depth	Enclosure depth [mm]	400	UC600FH
			600	UC6040BH
			800	UC6060BH
Segregation Form 3b	Horizontal top / bottom front	full size	UC600FH	
	Horizontal top / bottom back	Enclosure depth [mm]	400	UC6040BH
			600	UC6060BH
			800	UC6080BH
	Horizontal top / bottom full depth	Enclosure depth [mm]	400	UC6040FUH
			600	UC6060FUH
			800	UC6080FUH
Rear vertical	full size	UC6020V		
Segregation Form 4b	Terminal covers (front connection)	3 poles	HYT021H	
		4 poles	HYT022H	
	Terminal blocks	Phases	KX150NH	
		Neutral	KXB150LH	
	Segregation (rear connection)	In and out	UC200C	
In or out		UC600VD		

MCCB X250 / H250 - vertical

	In	100 A - 250 A / 40 A - 250 A				
	Orientation	Vertical				
	Poles	3 / 4				
	Type of device	X250 MCCB / H250 MCCB				
	Type of kit	Fix (op. rotary & ext. handle)				
	Reference	UC233XH	UC263XH*	UC283XH*		
						
	No. of devices per kit	1	2	3		
	Height x width of kit [mm]	300 x 350	300 x 600	300 x 800		
	Class II accessory	UC000XHP				
Segregation Form 2b	Lateral segregation front	full size	UC300FL			
	Lateral segregation back	Enclosure depth [mm]	400	UC3040BL		
			600	UC3060BL		
			800	UC3080BL		
	Lateral segregation full depth	Enclosure depth [mm]	400	UC3040FUL		
			600	UC3060FUL		
			800	UC3080FUL		
	Horizontal top / bottom full depth	Enclosure depth [mm]	400	UC3540FUH	UC6040FUH	UC8040FUH
			600	UC3560FUH	UC6060FUH	UC8060FUH
			800	UC3580FUH	UC6080FUH	UC8080FUH
Segregation Form 3b	Horizontal top / bottom front	full size	UC350FH	UC600FH	UC800FH	
	Horizontal top / bottom back	Enclosure depth [mm]	400	UC3540BH	UC6040BH	UC8040BH
			600	UC3560BH	UC6060BH	UC8060BH
			800	UC3580BH	UC6080BH	UC8080BH
	Horizontal top / bottom full depth	Enclosure depth [mm]	400	UC3540FUH	UC6040FUH	UC8040FUH
			600	UC3560FUH	UC6060FUH	UC8060FUH
			800	UC3580FUH	UC6080FUH	UC8080FUH
Rear vertical	full size	N.A.	UC6030V	UC8030V		
Segregation Form 4b	Terminal covers (front connection)	3 poles	HYS021H			
		4 poles	HYS022H			
	Terminal blocks	Phases	KX150NH			
		Neutral	KXB150LH			
	Segregation (rear connection)	In and out	N.A.	N.A.	N.A.	
		In or out	N.A.	N.A.	N.A.	

* Note: In case of more than 1 device per kit, the maximum reachable form of segregation is 2b.

MCCB X250 / H250 - vertical

	In	100 A - 250 A / 40 A - 250 A		
	Orientation	Vertical		
	Poles	3 / 4		
	Type of device	X250 MCCB / H250 MCCB		
	Type of kit	Fix (op. rotary & ext. handle) + RCD		
	Reference	UC234XHR	UC264XHR*	
				
	No. of devices per kit	1	2	
	Height x width of kit [mm]	400 x 350	400 x 600	
	Class II accessory	UC000XHP		
Segregation Form 2b	Lateral segregation front	full size	UC400FL	
	Lateral segregation back	Enclosure depth [mm] 400	UC4040BL	
		600	UC4060BL	
		800	UC4080BL	
	Lateral segregation full depth	Enclosure depth [mm] 400	UC4040FUL	
		600	UC4060FUL	
		800	UC4080FUL	
	Horizontal top / bottom full depth	Enclosure depth [mm] 400	UC3540FUH	UC6040FUH
		600	UC3560FUH	UC6060FUH
800		UC3580FUH	UC6080FUH	
Segregation Form 3b	Horizontal top / bottom front	full size	UC350FH	UC600FH
	Horizontal top / bottom back	Enclosure depth [mm] 400	UC3540BH	UC6040BH
		600	UC3560BH	UC6060BH
		800	UC3580BH	UC6080BH
	Horizontal top / bottom full depth	Enclosure depth [mm] 400	UC3540FUH	UC6040FUH
		600	UC3560FUH	UC6060FUH
		800	UC3580FUH	UC6080FUH
Rear vertical	full size	N.A.	UC6030V	
Segregation Form 4b	Terminal covers (front connection)	3 poles	HYT021H	
		4 poles	HYT022H	
	Terminal blocks	Phases	KX150NH	
		Neutral	KXB150LH	
	Segregation (rear connection)	In and out	N.A.	N.A.
In or out		N.A.	N.A.	

* Note: In case of more than 1 device per kit, the maximum reachable form of segregation is 2b.

MCCB X250 / H250 - horizontal

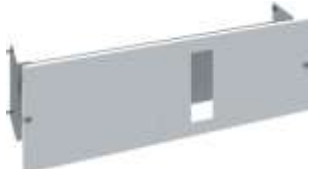
	In	100 A - 250 A / 40 A - 250 A			
	Orientation	Horizontal			
	Poles	3 / 4			
	Type of device	X250 MCCB / H250 MCCB			
	Type of kit	Fix (op. rotary & ext. handle) + RCD			
	Reference	UC262XHR	UC282XHR		
					
	No. of devices per kit	1	1		
	Height x width of kit [mm]	200 x 600	200 x 800		
	Class II accessory	UC000XHP			
Segregation Form 2b	Lateral segregation front	full size	UC200FL		
	Lateral segregation back	Enclosure depth [mm]	400	UC2040BL	
			600	UC2060BL	
			800	UC2080BL	
	Lateral segregation full depth	Enclosure depth [mm]	400	UC2040FUL	
			600	UC2060FUL	
			800	UC2080FUL	
	Horizontal top / bottom full depth	Enclosure depth [mm]	400	UC6040FUH	UC8040FUH
			600	UC6060FUH	UC8060FUH
			800	UC6080FUH	UC8080FUH
Segregation Form 3b	Horizontal top / bottom front	full size	UC350FH	UC600FH	
	Horizontal top / bottom back	Enclosure depth [mm]	400	UC600FH	UC800FH
			600	UC6040BH	UC8040BH
			800	UC6060BH	UC8060BH
	Horizontal top / bottom full depth	Enclosure depth [mm]	400	UC6080BH	UC8080BH
			600	UC6040FUH	UC8040FUH
			800	UC6060FUH	UC8060FUH
Rear vertical	full size	UC6020V			
Segregation Form 4b	Terminal covers (front connection)	3 poles	HYT021H		
		4 poles	HYT022H		
	Terminal blocks	Phases	KX150NH		
		Neutral	KXB150LH		
	Segregation (rear connection)	In and out	UC200C	UC200C	
In or out		UC600VD	UC800VD		

MCCB P630 - vertical

In		250 A - 630 A		
Orientation		Vertical		
Poles		3 / 4		
Type of device		P630 MCCB		
Type of kit		Fix (op. rotary & ext. handle)		
Reference		UC434PN	UC464PN*	
				
No. of devices per kit		1	2	
Height x width of kit [mm]		400 x 350	400 x 600	
Class II accessory		UC000XHP		
Segregation Form 2b	Lateral segregation front	full size	UC400FL	
	Lateral segregation back	Enclosure depth [mm] 400	UC4040BL	
		600	UC4060BL	
		800	UC4080BL	
	Lateral segregation full depth	Enclosure depth [mm] 400	UC4040FUL	
		600	UC4060FUL	
		800	UC4080FUL	
	Horizontal top / bottom full depth	Enclosure depth [mm] 400	UC3540FUH	UC6040FUH
		600	UC3560FUH	UC6060FUH
		800	UC3580FUH	UC6080FUH
Segregation Form 3b	Horizontal top / bottom front	full size	UC350FH	UC600FH
	Horizontal top / bottom back	Enclosure depth [mm] 400	UC3540BH	UC6040BH
		600	UC3560BH	UC6060BH
		800	UC3580BH	UC6080BH
	Horizontal top / bottom full depth	Enclosure depth [mm] 400	UC3540FUH	UC6040FUH
		600	UC3560FUH	UC6060FUH
		800	UC3580FUH	UC6080FUH
Rear vertical	full size	N.A.	UC6040V	
Segregation Form 4b	Terminal covers (front connection)	3 poles	HYW021H	
		4 poles	HYW022H	
	Terminal blocks up to 400 A	Phases	2 x KXB150LH	
		Neutral	2 x KXB150NH	
	Terminal blocks up to 630 A	Phases	N.A.	
		Neutral	N.A.	
Segregation (rear connection)	In and out	N.A.	N.A.	
	In or out	N.A.	N.A.	

* Note: In case of more than 1 device per kit, the maximum reachable form of segregation is 2b.

MCCB P630 - vertical

	In		250 A - 630 A		
	Orientation		Vertical		
	Poles		3 / 4		
	Type of device		P630 MCCB		
	Type of kit		Plug-in		
	Reference	UC466PPN*	UC486PPN*		
	No. of devices per kit		2 3		
	Height x width of kit [mm]		600 x 600 600 x 800		
	Class II accessory		UC000XHP		
Segregation Form 2b	Lateral segregation front	full size	UC600FL		
	Lateral segregation back	Enclosure depth [mm]	400	UC6040BL	
			600	UC6060BL	
			800	UC6080BL	
	Lateral segregation full depth	Enclosure depth [mm]	400	UC6040FUL	
			600	UC6060FUL	
			800	UC6080FUL	
	Horizontal top / bottom full depth	Enclosure depth [mm]	400	UC6040FUH	UC8040FUH
			600	UC6060FUH	UC8060FUH
			800	UC6080FUH	UC8080FUH
Segregation Form 3b	Horizontal top / bottom front	full size	UC600FH	UC800FH	
	Horizontal top / bottom back	Enclosure depth [mm]	400	UC6040BH	UC8040BH
			600	UC6060BH	UC8060BH
			800	UC6080BH	UC8080BH
	Horizontal top / bottom full depth	Enclosure depth [mm]	400	UC6040FUH	UC8040FUH
			600	UC6060FUH	UC8060FUH
			800	UC6080FUH	UC8080FUH
Rear vertical	full size	UC6060V	UC8060V		
Segregation Form 4b	Terminal covers (front connection)	3 poles	HYW021H		
		4 poles	HYW022H		
	Terminal blocks up to 400 A	Phases	2 x KXB150LH		
		Neutral	2 x KXB150NH		
	Terminal blocks up to 630 A	Phases	N.A.		
		Neutral	N.A.		
Segregation (rear connection)	In and out	N.A.	N.A.		
	In or out	N.A.	N.A.		

* Note: In case of more than 1 device per kit, the maximum reachable form of segregation is 2b.

MCCB P630 - vertical

	In	250 A - 630 A		
	Orientation	Vertical		
	Poles	3 / 4		
	Type of device	P630 MCCB		
	Type of kit	Fix (op. rotary & ext. handle) + RCD		
	Reference	UC436PRN	UC466PRN*	
				
	No. of devices per kit	1	2	
	Height x width of kit [mm]	600 x 350	600 x 600	
	Class II accessory	UC000XHP		
Segregation Form 2b	Lateral segregation front	full size	UC600FL	
	Lateral segregation back	Enclosure depth [mm] 400	UC6040BL	
		600	UC6060BL	
		800	UC6080BL	
	Lateral segregation full depth	Enclosure depth [mm] 400	UC6040FUL	
		600	UC6060FUL	
		800	UC6080FUL	
	Horizontal top / bottom full depth	Enclosure depth [mm] 400	UC3540FUH	UC6040FUH
		600	UC3560FUH	UC6060FUH
		800	UC3580FUH	UC6080FUH
Segregation Form 3b	Horizontal top / bottom front	full size	UC350FH	UC600FH
	Horizontal top / bottom back	Enclosure depth [mm] 400	UC3540BH	UC6040BH
		600	UC3560BH	UC6060BH
		800	UC3580BH	UC6080BH
	Horizontal top / bottom full depth	Enclosure depth [mm] 400	UC3540FUH	UC6040FUH
		600	UC3560FUH	UC6060FUH
		800	UC3580FUH	UC6080FUH
Rear vertical	full size	N.A.	UC6060V	
Segregation Form 4b	Terminal covers (front connection)	3 poles	HYW021H	
		4 poles	HYW022H	
	Terminal blocks up to 400 A	Phases	2 x KXB150LH	
		Neutral	2 x KXB150NH	
	Terminal blocks up to 630 A	Phases	N.A.	
		Neutral	N.A.	
Segregation (rear connection)	In and out	N.A.	N.A.	
	In or out	N.A.	N.A.	

* Note: In case of more than 1 device per kit, the maximum reachable form of segregation is 2b.

MCCB P630 - vertical

In		250 A - 630 A				
Orientation		Vertical				
Poles		3 / 4				
Type of device		P630 MCCB				
Type of kit		Draw-out				
Reference		UC436PWN	UC466PWN	UC486PWN*		
No. of devices per kit		1	1	2		
Height x width of kit [mm]		600 x 350	600 x 600	600 x 800		
Class II accessory		UC000XHP				
Segregation Form 2b	Lateral segregation front	full size	UC600FL			
	Lateral segregation back	Enclosure depth [mm]	400	UC6040BL		
			600	UC6060BL		
			800	UC6080BL		
	Lateral segregation full depth	Enclosure depth [mm]	400	UC6040FUL		
			600	UC6060FUL		
			800	UC6080FUL		
	Horizontal top / bottom full depth	Enclosure depth [mm]	400	UC3540FUH	UC6040FUH	UC8040FUH
			600	UC3560FUH	UC6060FUH	UC8060FUH
			800	UC3580FUH	UC6080FUH	UC8080FUH
Segregation Form 3b	Horizontal top / bottom front	full size	UC350FH	UC600FH	UC800FH	
	Horizontal top / bottom back	Enclosure depth [mm]	400	UC3540BH	UC6040BH	UC8040BH
			600	UC3560BH	UC6060BH	UC8060BH
			800	UC3580BH	UC6080BH	UC8080BH
	Horizontal top / bottom full depth	Enclosure depth [mm]	400	UC3540FUH	UC6040FUH	UC8040FUH
			600	UC3560FUH	UC6060FUH	UC8060FUH
			800	UC3580FUH	UC6080FUH	UC8080FUH
Rear vertical	full size	N.A.	UC6060V	UC8060V		
Segregation Form 4b	Terminal covers (front connection)	3 poles	HYW021H			
		4 poles	HYW022H			
	Terminal blocks up to 400 A	Phases	2 x KXB150LH			
		Neutral	2 x KXB150NH			
	Terminal blocks up to 630 A	Phases	N.A.			
		Neutral	N.A.			
Segregation (rear connection)	In and out	N.A.	N.A.	N.A.		
	In or out	N.A.	N.A.	N.A.		

* Note: In case of more than 1 device per kit, the maximum reachable form of segregation is 2b.

MCCB P630 - vertical

	In	250 A - 630 A			
	Orientation	Vertical			
	Poles	3 / 4			
	Type of device	P630 MCCB			
	Type of kit	Motorized	Multiple		
	Reference	UC464PMN*	UC484PDN*		
					
	No. of devices per kit	2	3		
	Height x width of kit [mm]	400 x 600	400 x 800		
	Class II accessory	UC000XHP	N.A.		
Segregation Form 2b	Lateral segregation front	full size	UC400FL		
	Lateral segregation back	Enclosure depth [mm]	400	UC4040BL	
		600	UC4060BL		
		800	UC4080BL		
	Lateral segregation full depth	Enclosure depth [mm]	400	UC4040FUL	
		600	UC4060FUL		
		800	UC4080FUL		
	Horizontal top / bottom full depth	Enclosure depth [mm]	400	UC6040FUH	N.A.
		600	UC6060FUH	N.A.	
800		UC6080FUH	N.A.		
Segregation Form 3b	Horizontal top / bottom front	full size	UC600FH	N.A.	
	Horizontal top / bottom back	Enclosure depth [mm]	400	UC6040BH	N.A.
		600	UC6060BH	N.A.	
		800	UC6080BH	N.A.	
	Horizontal top / bottom full depth	Enclosure depth [mm]	400	UC6040FUH	N.A.
		600	UC6060FUH	N.A.	
		800	UC6080FUH	N.A.	
Rear vertical	full size	UC6040V	N.A.		
Segregation Form 4b	Terminal covers (front connection)	3 poles	HYW021H	N.A.	
		4 poles	HYW022H	N.A.	
	Terminal blocks up to 400 A	Phases	2 x KXB150LH	N.A.	
		Neutral	2 x KXB150NH	N.A.	
	Terminal blocks up to 630 A	Phases	N.A.	N.A.	
		Neutral	N.A.	N.A.	
	Segregation (rear connection)	In and out	N.A.	N.A.	
In or out		N.A.	N.A.		

* Note: In case of more than 1 device per kit, the maximum reachable form of segregation is 2b.

MCCB P630 - horizontal

	In		250 A - 630 A		
	Orientation		Horizontal		
	Poles		3 / 4		
	Type of device		P630 MCCB		
	Type of kit		Fix (op. rotary & ext. handle) + RCD		
	Reference		UC463PRN	UC483PRN	
					
	No. of devices per kit		1	1	
	Height x width of kit [mm]		300 x 600	300 x 800	
	Class II accessory		UC000XHP		
Segregation Form 2b	Lateral segregation front	full size	UC300FL		
	Lateral segregation back	Enclosure depth [mm]	400	UC3040BL	
			600	UC3060BL	
			800	UC3080BL	
	Lateral segregation full depth	Enclosure depth [mm]	400	UC3040FUL	
			600	UC3060FUL	
			800	UC3080FUL	
	Horizontal top / bottom full depth	Enclosure depth [mm]	400	UC6040FUH	UC8040FUH
			600	UC6060FUH	UC8060FUH
			800	UC6080FUH	UC8080FUH
Segregation Form 3b	Horizontal top / bottom front	full size	UC600FH	UC800FH	
	Horizontal top / bottom back	Enclosure depth [mm]	400	UC6040BH	UC8040BH
			600	UC6060BH	UC8060BH
			800	UC6080BH	UC8080BH
	Horizontal top / bottom full depth	Enclosure depth [mm]	400	UC6040FUH	UC8040FUH
			600	UC6060FUH	UC8060FUH
			800	UC6080FUH	UC8080FUH
Rear vertical	full size	UC6030V	UC8030V		
Segregation Form 4b	Terminal covers (front connection)	3 poles	HYW021H		
		4 poles	HYW022H		
	Terminal blocks up to 400 A	Phases	2 x KXB150LH		
		Neutral	2 x KXB150NH		
	Terminal blocks up to 630 A	Phases	N.A.		
		Neutral	N.A.		
Segregation (rear connection)	In and out	UC300C	UC300C		
	In or out	UC600VD	UC800VD		

MCCB P630 - horizontal

	In	250 A - 630 A				
	Orientation	Horizontal				
	Poles	3 / 4				
	Type of device	P630 MCCB				
	Type of kit	Plug-in		Draw-out		
	Reference	UC463PPN	UC483PPN	UC463PWN		
	No. of devices per kit	1	1	1		
	Height x width of kit [mm]	300 x 600	300 x 800	300 x 600		
	Class II accessory	UC000XHP				
Segregation Form 2b	Lateral segregation front	full size	UC300FL			
	Lateral segregation back	Enclosure depth [mm]	400	UC3040BL		
			600	UC3060BL		
			800	UC3080BL		
	Lateral segregation full depth	Enclosure depth [mm]	400	UC3040FUL		
			600	UC3060FUL		
			800	UC3080FUL		
	Horizontal top / bottom full depth	Enclosure depth [mm]	400	UC6040FUH	UC8040FUH	UC6040FUH
			600	UC6060FUH	UC8060FUH	UC6060FUH
			800	UC6080FUH	UC8080FUH	UC6080FUH
Segregation Form 3b	Horizontal top / bottom front	full size	UC600FH	UC800FH	UC600FH	
	Horizontal top / bottom back	Enclosure depth [mm]	400	UC6040BH	UC8040BH	UC6040BH
			600	UC6060BH	UC8060BH	UC6060BH
			800	UC6080BH	UC8080BH	UC6080BH
	Horizontal top / bottom full depth	Enclosure depth [mm]	400	UC6040FUH	UC8040FUH	UC6040FUH
			600	UC6060FUH	UC8060FUH	UC6060FUH
			800	UC6080FUH	UC8080FUH	UC6080FUH
Rear vertical	full size	UC6030V	UC8030V	UC6030V		
Segregation Form 4b	Terminal covers (front connection)	3 poles	HYW021H			
		4 poles	HYW022H			
	Terminal blocks up to 400 A	Phases	2 x KXB150LH			
		Neutral	2 x KXB150NH			
	Terminal blocks up to 630 A	Phases	N.A.			
		Neutral	N.A.			
Segregation (rear connection)	In and out	UC300C	UC300C	UC300C		
	In or out	UC600VD	UC800VD	UC600VD		

MCCB X250-X630 - vertical

	In	250 A - 630 A			
	Orientation	Vertical			
	Poles	3 / 4			
	Type of device	X630 MCCB			
	Type of kit	Fix (op. rotary & ext. handle)			
	Reference	UC434XN	UC464XN*		
					
	No. of devices per kit	1	2		
	Height x width of kit [mm]	400 x 350	400 x 600		
	Class II accessory	UC000XHP			
Segregation Form 2b	Lateral segregation front	full size	UC400FL		
	Lateral segregation back	Enclosure depth [mm]	400	UC4040BL	
			600	UC4060BL	
			800	UC4080BL	
	Lateral segregation full depth	Enclosure depth [mm]	400	UC4040FUL	
			600	UC4060FUL	
			800	UC4080FUL	
	Horizontal top / bottom full depth	Enclosure depth [mm]	400	UC3540FUH	UC6040FUH
			600	UC3560FUH	UC6060FUH
			800	UC3580FUH	UC6080FUH
Segregation Form 3b	Horizontal top / bottom front	full size	UC350FH	UC600FH	
	Horizontal top / bottom back	Enclosure depth [mm]	400	UC3540BH	UC6040BH
			600	UC3560BH	UC6060BH
			800	UC3580BH	UC6080BH
	Horizontal top / bottom full depth	Enclosure depth [mm]	400	UC3540FUH	UC6040FUH
			600	UC3560FUH	UC6060FUH
			800	UC3580FUH	UC6080FUH
Rear vertical	full size	N.A.	UC6040V		
Segregation Form 4b	Terminal covers (front connection)	3 poles	HYW021H		
		4 poles	HYW022H		
	Terminal blocks up to 400 A	Phases	2 x KXB150LH		
		Neutral	2 x KXB150NH		
	Terminal blocks up to 630 A	Phases	N.A.		
		Neutral	N.A.		
Segregation (rear connection)	In and out	N.A.	N.A.		
	In or out	N.A.	N.A.		

* Note: In case of more than 1 device per kit, the maximum reachable form of segregation is 2b.

MCCB X250-X630 - vertical

	In	250 A - 630 A				
	Orientation	Vertical				
	Poles	3 / 4				
	Type of device	X630 MCCB				
	Type of kit	Fix (op. rotary & ext. handle) + RCD	Multiple			
	Reference	UC436XRN	UC466XRN*	UC484XDN*		
						
	No. of devices per kit	1	2	3		
	Height x width of kit [mm]	600 x 350	600 x 600	400 x 800		
	Class II accessory	UC000XHP		N.A.		
Segregation Form 2b	Lateral segregation front	full size	UC600FL	UC400FL		
	Lateral segregation back	Enclosure depth [mm]	400	UC6040BL	UC4040BL	
			600	UC6060BL	UC4060BL	
			800	UC6080BL	UC4080BL	
	Lateral segregation full depth	Enclosure depth [mm]	400	UC6040FUL	UC4040FUL	
			600	UC6060FUL	UC4060FUL	
			800	UC6080FUL	UC4080FUL	
	Horizontal top / bottom full depth	Enclosure depth [mm]	400	UC3540FUH	UC6040FUH	N.A.
			600	UC3560FUH	UC6060FUH	N.A.
			800	UC3580FUH	UC6080FUH	N.A.
Segregation Form 3b	Horizontal top / bottom front	full size	UC350FH	UC600FH	N.A.	
	Horizontal top / bottom back	Enclosure depth [mm]	400	UC3540BH	UC6040BH	N.A.
			600	UC3560BH	UC6060BH	N.A.
			800	UC3580BH	UC6080BH	N.A.
	Horizontal top / bottom full depth	Enclosure depth [mm]	400	UC3540FUH	UC6040FUH	N.A.
			600	UC3560FUH	UC6060FUH	N.A.
			800	UC3580FUH	UC6080FUH	N.A.
Rear vertical	full size	N.A.	UC6060V	N.A.		
Segregation Form 4b	Terminal covers (front connection)	3 poles	HYW021H		N.A.	
		4 poles	HYW022H		N.A.	
	Terminal blocks up to 400 A	Phases	2 x KXB150LH		N.A.	
		Neutral	2 x KXB150NH		N.A.	
	Terminal blocks up to 630 A	Phases	N.A.			
		Neutral	N.A.			
Segregation (rear connection)	In and out	N.A.	N.A.	N.A.		
	In or out	N.A.	N.A.	N.A.		

* Note: In case of more than 1 device per kit, the maximum reachable form of segregation is 2b.

MCCB X250-X630 - horizontal

	In		250 A - 630 A		
	Orientation		Horizontal		
	Poles		3 / 4		
	Type of device		X630 MCCB		
	Type of kit		Fix (op. rotary & ext. handle) + RCD		
	Reference	UC463XRN	UC483XRN		
					
	No. of devices per kit	1	1		
	Height x width of kit [mm]	300 x 600	300 x 800		
	Class II accessory		UC000XHP		
Segregation Form 2b	Lateral segregation front	full size	UC300FL		
	Lateral segregation back	Enclosure depth [mm]	400	UC3040BL	
			600	UC3060BL	
			800	UC3080BL	
	Lateral segregation full depth	Enclosure depth [mm]	400	UC3040FUL	
			600	UC3060FUL	
			800	UC3080FUL	
	Horizontal top / bottom full depth	Enclosure depth [mm]	400	UC6040FUH	UC8040FUH
			600	UC6060FUH	UC8060FUH
			800	UC6080FUH	UC8080FUH
Segregation Form 3b	Horizontal top / bottom front	full size	UC600FH	UC800FH	
	Horizontal top / bottom back	Enclosure depth [mm]	400	UC6040BH	UC8040BH
			600	UC6060BH	UC8060BH
			800	UC6080BH	UC8080BH
	Horizontal top / bottom full depth	Enclosure depth [mm]	400	UC6040FUH	UC8040FUH
			600	UC6060FUH	UC8060FUH
			800	UC6080FUH	UC8080FUH
Rear vertical	full size	UC6030V	UC8030V		
Segregation Form 4b	Terminal covers (front connection)	3 poles	HYW021H		
		4 poles	HYW022H		
	Terminal blocks up to 400 A	Phases	2 x KXB150LH		
		Neutral	2 x KXB150NH		
	Terminal blocks up to 630 A	Phases	N.A.		
		Neutral	N.A.		
Segregation (rear connection)	In and out	UC300C	UC300C		
	In or out	UC600VD	UC800VD		

MCCB H1000 - vertical

	In	630 A - 1000 A		
	Orientation	Vertical		
	Poles	3 / 4		
	Type of device	H1000 MCCB		
	Type of kit	Fix		
	Reference	UC566H	UC586H*	
				
	No. of devices per kit	1	2	
	Height x width of kit [mm]	600 x 600	600 x 800	
	Class II accessory	UC000XHP		
Segregation Form 2b	Lateral segregation front	full size	UC1000V	
	Lateral segregation back	Enclosure depth [mm]	400	N.A.
			600	N.A.
			800	N.A.
	Lateral segregation full depth	Enclosure depth [mm]	400	N.A.
			600	N.A.
			800	N.A.
	Horizontal top / bottom full depth	Enclosure depth [mm]	400	N.A.
			600	N.A.
			800	N.A.
	Segregation Form 3b	Horizontal top / bottom front	full size	UC1000BH
		Horizontal top / bottom back	Enclosure depth [mm]	400
			600	N.A.
			800	N.A.
Horizontal top / bottom full depth		Enclosure depth [mm]	400	N.A.
			600	N.A.
			800	N.A.
Rear vertical	full size	N.A.		
Seg. Form 4b	Terminal covers (front connection)	3 poles	HYW021H	
		4 poles	HYW022H	
	Segregation (rear connection)	In and out	N.A.	N.A.
		In or out	N.A.	N.A.

* Note: In case of more than 1 device per kit, the maximum reachable form of segregation is 2b.

MCCB H1000 - vertical

	In	630 A - 1000 A		
	Orientation	Vertical		
	Poles	3 / 4		
	Type of device	H1000 MCCB		
	Type of kit	Motorized		
	Reference	UC566HM	UC586HM*	
				
	No. of devices per kit	1	2	
	Height x width of kit [mm]	600 x 600	600 x 800	
	Class II accessory	UC000XHP		
Segregation Form 2b	Lateral segregation front	full size	UC1000V	
	Lateral segregation back	Enclosure depth [mm]	400	N.A.
			600	N.A.
			800	N.A.
	Lateral segregation full depth	Enclosure depth [mm]	400	N.A.
			600	N.A.
			800	N.A.
	Horizontal top / bottom full depth	Enclosure depth [mm]	400	N.A.
			600	N.A.
			800	N.A.
	Segregation Form 3b	Horizontal top / bottom front	full size	UC1000BH
		Horizontal top / bottom back	Enclosure depth [mm]	400
			600	N.A.
			800	N.A.
Horizontal top / bottom full depth		Enclosure depth [mm]	400	N.A.
			600	N.A.
			800	N.A.
Rear vertical	full size	N.A.		
Seg. Form 4b	Terminal covers (front connection)	3 poles	HYW021H	
		4 poles	HYW022H	
	Segregation (rear connection)	In and out	N.A.	N.A.
		In or out	N.A.	N.A.

* Note: In case of more than 1 device per kit, the maximum reachable form of segregation is 2b.

MCCB H1000 - vertical

	In	630 A - 1000 A		
	Orientation	Vertical		
	Poles	3 / 4		
	Type of device	H1000 MCCB		
	Type of kit	Multiple	Multiple + Motorized	
	Reference	UC586HD*	UC586HDM*	
	No. of devices per kit	2	2	
	Height x width of kit [mm]	600 x 800	600 x 800	
	Class II accessory	UC000XHP		
Segregation Form 2b	Lateral segregation front	full size	UC600FL	
	Lateral segregation back	Enclosure depth [mm]	400	UC6040BL
			600	UC6060BL
			800	UC6080BL
	Lateral segregation full depth	Enclosure depth [mm]	400	UC6040FUL
			600	UC6060FUL
			800	UC6080FUL
	Horizontal top / bottom full depth	Enclosure depth [mm]	400	UC8040FUH
			600	UC8060FUH
			800	UC8080FUH
Segregation Form 3b	Horizontal top / bottom front	full size	N.A.	
	Horizontal top / bottom back	Enclosure depth [mm]	400	N.A.
			600	N.A.
			800	N.A.
	Horizontal top / bottom full depth	Enclosure depth [mm]	400	UC8040FUH
			600	UC8060FUH
			800	UC8080FUH
Rear vertical	full size	N.A.		
Seg. Form 4b	Terminal covers (front connection)	3 poles	N.A.	
		4 poles	N.A.	
	Segregation (rear connection)	In and out	N.A.	N.A.
In or out		N.A.	N.A.	

* Note: In case of more than 1 device per kit, the maximum reachable form of segregation is 2b.

MCCB H1000 - horizontal

	In	630 A - 1000 A			
	Orientation	Horizontal			
	Poles	3 / 4			
	Type of device	H1000 MCCB			
	Type of kit	Fix			
	Reference	UC564H	UC584H		
					
	No. of devices per kit	1	1		
	Height x width of kit [mm]	400 x 600	400 x 800		
	Class II accessory	UC000XHP			
Segregation Form 2b	Lateral segregation front	full size	UC400FL		
	Lateral segregation back	Enclosure depth [mm]	400	UC4040BL	
			600	UC4060BL	
			800	UC4080BL	
	Lateral segregation full depth	Enclosure depth [mm]	400	UC4040FUL	
			600	UC4060FUL	
			800	UC4080FUL	
	Horizontal top / bottom full depth	Enclosure depth [mm]	400	UC6040FUH	UC8040FUH
			600	UC6060FUH	UC8060FUH
			800	UC6080FUH	UC8080FUH
Segregation Form 3b	Horizontal top / bottom front	full size	UC600FH	UC800FH	
	Horizontal top / bottom back	Enclosure depth [mm]	400	UC6040BH	UC8040BH
			600	UC6060BH	UC8060BH
			800	UC6080BH	UC8080BH
	Horizontal top / bottom full depth	Enclosure depth [mm]	400	UC6040FUH	UC8040FUH
			600	UC6060FUH	UC8060FUH
			800	UC6080FUH	UC8080FUH
Rear vertical	full size	UC6040V	UC8040V		
Seg. Form 4b	Terminal covers (front connection)	3 poles	HYE021H		
		4 poles	HYE022H		
	Segregation (rear connection)	In and out	N.A.	N.A.	
		In or out	UC600VD	UC800VD	

MCCB H1600 - vertical

	In		1250 A - 1600 A
	Orientation		Vertical
	Poles		3 / 4
	Type of device		H1600 MCCB
	Type of kit		Fix
	Reference	UC666H	UC686H
			
	No. of devices per kit	1	1
	Height x width of kit [mm]	600 x 600	600 x 800
	Class II accessory	UC000XHP	
Segregation	Form 2b Segregation plate	full size	UC1600V
	Form 3b/4b Segregation plate	full size	UC1600BH

MCCB H1600 - vertical

	In	1250 A - 1600 A		
	Orientation	Vertical		
	Poles	3 / 4		
	Type of device	H1600 MCCB		
	Type of kit	Motorized		Multiple
	Reference	UC666HM	UC686HM	UC686HD*
				
	No. of devices per kit	1	1	2
	Height x width of kit [mm]	600 x 600	600 x 800	600 x 800
	Class II accessory	UC000XHP		UC000XHP
Segregation	Form 2b Segregation plate	full size	UC1600V	N.A.
	Form 3b/4b Segregation plate	full size	UC1600BH	N.A.

* Note: In case of more than 1 device per kit, the maximum reachable form of segregation is 2b.

3.7.3 ACB air circuit breaker

ACB HWT Type

In		800 A - 1600 A Frame 1	800 A - 2000 A Frame 1	2500 A - 3200 A - 4000 A Frame 2
Orientation		Vertical		
Poles		3 / 4		
Type of device		ACB		
Type of kit		Fix and Draw-out		
Reference		UC766HWT	UC786HWT	UC886HWT
				
No. of devices per kit		1	1	1
Height x width of kit [mm]		600 x 600	600 x 800	600 x 800
Front connection		Available in ACB configuration		N.A.
Rear connection		Available in ACB configuration		
Class II accessory		N.A.		
Segregation	Form 2b Lateral segregation full depth	Enclosure depth [mm]	400	N.A.
			600	UC3060FUL
			800	UC3080FUL
	Form 3b/4b Segregation plate	Full size	UC6060HWT	UC6080HWT

ACB HW Type

		In	Up to 2000 A	From 2000 A to 4000 A
Orientation		Vertical		
Poles		3 / 4		
Type of device		ACB		
Type of kit		Fix and Draw-out		
Reference		UC766HW	UC886HW	
				
No. of devices per kit		1	1	
Height x width of kit [mm]		600 x 600	600 x 800	
Front connection		Available in ACB configuration		
Rear connection		Available in ACB configuration		
Class II accessory		N.A.		
Segregation	Form 2b	Enclosure depth [mm]	400	N.A.
	Lateral segregation		600	UC3060FUL
	full depth		800	UC3080FUL
	Form 3b/4b	Full size	UC6060HW	UC6080HW
Segregation plate				

3.7.4 SWITCH + ATS

SWITCH + ATS HA 160 A - 250 A

In		160 A - 250 A				
Orientation		Vertical				
Poles		3 / 4				
Type of device		HA				
Type of kit		Fix				
Reference		UC233HA	UC263HA	UC283HA		
						
No. of devices per kit		1	1	1		
Height x width of kit [mm]		300 x 350	300 x 600	300 x 800		
Terminal covers		Available as accessory				
Front connection		Included in the device				
Class II accessory		N.A.				
Segregation Form 2b/3b	Lateral segregation full depth	Enclosure depth [mm]	400	UC3040FUL		
			600	UC3060FUL		
			800	UC3080FUL		
	Horizontal top / bottom full depth	Enclosure depth [mm]	400	UC3540FUH	UC6040FUH	UC8040FUH
			600	UC3560FUH	UC6060FUH	UC8060FUH
			800	UC3580FUH	UC6080FUH	UC8080FUH

SWITCH + ATS HA 630 A

	In		630 A		
	Orientation		Vertical		
	Poles		3 / 4		
	Type of device		HA		
	Type of kit		Fix		
	Reference	UC466HA	UC486HA		
					
	No. of devices per kit	1	1		
	Height x width of kit [mm]	600 x 600	600 x 800		
	Terminal covers	Available as accessory			
	Front connection	Included in the device			
	Class II accessory	N.A.			
Segregation Form 2b/3b	Lateral segregation full depth	Enclosure depth [mm]	400	UC6040FUL	
			600	UC6060FUL	
			800	UC6080FUL	
	Horizontal top / bottom full depth	Enclosure depth [mm]	400	UC6040FUH	UC8040FUH
			600	UC6060FUH	UC8060FUH
			800	UC6080FUH	UC8080FUH

SWITCH + ATS HA 1600 A + 3200 A

In		1600 A		3200 A
Orientation		Vertical		
Poles		3 / 4		
Type of device		HA		
Type of kit		Fix		
Reference		UC666HA	UC686HA	UC886HA
				
No. of devices per kit		1	1	1
Height x width of kit [mm]		600 x 600	600 x 800	600 x 800
Terminal covers		Available as accessory		
Front connection		Included in the device		
Class II accessory		N.A.		
Segregation Form 2b/3b	Lateral segregation full depth	Enclosure depth [mm]	400	UC3040FUL
			600	UC3060FUL
			800	UC3080FUL
	Horizontal top / bottom full depth	Enclosure depth [mm]	400	N.A.
			600	N.A.
			800	N.A.

SWITCH + ATS HI 160 A - 400 A

	In	160 A - 400 A				
	Orientation	Vertical				
	Poles	3 / 4				
	Type of device	HI				
	Type of kit	Fix				
	Reference	UC163HI	UC183HI			
	No. of devices per kit	1	1			
	Height x width of kit [mm]	300 x 600	300 x 800			
	Terminal covers	Available as accessory				
	Front connection	Included in the device				
	Class II accessory	N.A.				
Segregation Form 2b/3b	Lateral segregation full depth	Enclosure depth [mm]	400	UC3040FUL		
			600	UC3060FUL		
			800	UC3080FUL		
	Horizontal top / bottom full depth	Enclosure depth [mm]	400	UC6040FUH	UC8040FUH	
			600	UC6060FUH	UC8060FUH	
			800	UC6080FUH	UC8080FUH	

SWITCH + ATS HI 630 A + 3200 A

In		630 A		3200 A		
Orientation		Vertical				
Poles		3 / 4				
Type of device		HI				
Type of kit		Fix				
Reference		UC463HI	UC483HI	UC686HI		
No. of devices per kit		1	1	1		
Height x width of kit [mm]		300 x 600	300 x 800	600 x 800		
Terminal covers		Available as accessory				
Front connection		Included in the device				
Class II accessory		N.A.				
Segregation Form 2b/3b	Lateral segregation full depth	Enclosure depth [mm]	400	UC3040FUL		
		600	UC3060FUL			
		800	UC3080FUL			
	Horizontal top / bottom full depth	Enclosure depth [mm]	400	UC6040FUH	UC8040FUH	N.A.
		600	UC6060FUH	UC8060FUH	N.A.	
		800	UC6080FUH	UC8080FUH	N.A.	

SWITCH + ATS HIC 63 A - 160 A

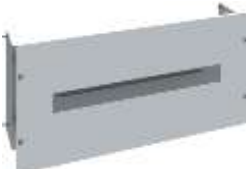
	In	63 A - 160 A			
	Orientation	Vertical			
	Poles	3 / 4			
	Type of device	HIC, modular			
	Type of kit	Fix			
	Reference	UC163HIC	UC183HIC		
					
	No. of devices per kit	1	1		
	Height x width of kit [mm]	300 x 600	300 x 800		
	Terminal covers	Available as accessory			
	Front connection	Included in the device			
	Class II accessory	N.A.			
Segregation Form 2b/3b	Lateral segregation full depth	Enclosure depth [mm]	400	UC3040FUL	
			600	UC3060FUL	
			800	UC3080FUL	
	Horizontal top / bottom full depth	Enclosure depth [mm]	400	UC6040FUH	UC8040FUH
			600	UC6060FUH	UC8060FUH
			800	UC6080FUH	UC8080FUH

SWITCH + ATS HIC 630 A

	In	250 A - 630 A				
	Orientation	Vertical				
	Poles	3 / 4				
	Type of device	HIC, not modular				
	Type of kit	Fix				
	Reference	UC463HIC	UC483HIC			
						
	No. of devices per kit	1	1			
	Height x width of kit [mm]	300 x 600	300 x 800			
	Terminal covers	Available as accessory				
	Front connection	Included in the device				
	Class II accessory	N.A.				
Segregation Form 2b/3b	Lateral segregation full depth	Enclosure depth [mm]	400	UC3040FUL		
			600	UC3060FUL		
			800	UC3080FUL		
	Horizontal top / bottom full depth	Enclosure depth [mm]	400	UC6040FUH	UC8040FUH	
			600	UC6060FUH	UC8060FUH	
			800	UC6080FUH	UC8080FUH	

SWITCH + ATS HIC 1600 A + 3200 A

In		800 A - 1600 A		3200 A	
Orientation		Vertical			
Poles		3 / 4			
Type of device		HIC / HIB, not modular			
Type of kit		Fix			
Reference		UC686HIC		UC886HIC	
					
No. of devices per kit		1		1	
Height x width of kit [mm]		600 x 800		600 x 800	
Terminal covers		Available as accessory			
Front connection		Included in the device			
Class II accessory		N.A.			
Segregation Form 2b/3b	Lateral segregation full depth	Enclosure depth [mm]	400	UC6040FUL	
			600	UC6060FUL	
			800	UC6080FUL	
	Horizontal top / bottom full depth	Enclosure depth [mm]	400	N.A.	
			600	N.A.	
			800	N.A.	

3.7.5 Fuse LT

Vertical mounting

In		160 A	250 A	630 A	
Orientation		Vertical			
Poles		3 / 4			
Type of device		LT			
Type of kit		Fix			
					
Reference		UC161LT	UC163LT	UC264LT	UC464LT
No. of devices per kit		1	3	1	1
Height x width of kit [mm]		300 x 600	300 x 600	400 x 600	400 x 600
Terminal covers		N.A.			
Front connection		N.A.			
Rear connection		N.A.			
Class II accessory		UC000XHP			
Segregation Form 2b	Lateral segregation front	full size	UC300FL	UC400FL	
	Lateral segregation back	Enclosure depth [mm]	400	UC3040BL	UC4040BL
		600	UC3060BL	UC4060BL	
		800	UC3080BL	UC4080BL	
	Lateral segregation full depth	Enclosure depth [mm]	400	UC3040FUL	UC4040FUL
		600	UC3060FUL	UC4060FUL	
		800	UC3080FUL	UC4080FUL	
	Horizontal top / bottom full depth	Enclosure depth [mm]	400	UC6040FUH	
		600	UC6060FUH		
		800	UC6080FUH		

Note : For the design tested version the maximum reachable form of segregation is 2b for the vertical kits

3.7.6 MCB

Vertical mounting

In	Up to 125 A					
Orientation	Vertical					
Poles	3 / 4					
Type of device	MCB and other modular devices					
Type of kit	Fix					
Reference	UC1530MD	UC1560MD	UC1580MD	UC2060MD	UC2080MD	
						
No. of devices per kit	10 mod	24 mod	36 mod	24 mod	36 mod	
Height x width of kit [mm]	150 x 350	150 x 600	150 x 800	200 x 600	200 x 800	
Terminal covers	N.A.					
Front connection	N.A.					
Rear connection	N.A.					
Class II accessory	N.A.					
Complete box	All	N.A.	UC6015FMD	UC8015MFD	UC6020FMD	UC8020FMD

Note : For the design tested version the maximum reachable form of segregation is 2b

In	Up to 125 A			
Orientation	Vertical			
Poles	3 / 4			
Type of device	MCB and terminal			
Type of kit	Adjustable in depth			
Reference	UC2035AMD	UC2060AMD	UC2080AMD	
				
No. of devices per kit	10 mod	24 mod	36 mod	
Height x width of kit [mm]	200 x 350	200 x 600	200 x 800	
Terminal covers	N.A.			
Front connection	N.A.			
Rear connection	N.A.			
Class II accessory	N.A.			
Complete box	All	N.A.	UC6020FMD	UC8020FMD

Note : For the design tested version the maximum reachable form of segregation is 2b

3.7.7 Mounting plate

Universal mounting

Mounting plates are used to mount other kind of equipment inside the board, where a standard kit can't be found.

Reference		UC2060MP	UC2080MP	
Height x width of kit [mm]		200 x 600	200 x 800	
Type of kit		Fix		
				
Class II accessory		UC000XHP		
Segregation Form 2b	Lateral segregation front	full size	UC200FL	
	Lateral segregation back	Enclosure depth [mm] 400	UC2040BL	
		600	UC2060BL	
		800	UC2080BL	
	Lateral segregation full depth	Enclosure depth [mm] 400	UC2040FUL	
		600	UC2060FUL	
		800	UC2080FUL	
	Horizontal top / bottom full depth	Enclosure depth [mm] 400	UC6040FUH	UC8040FUH
		600	UC6060FUH	UC8060FUH
		800	UC6080FUH	UC8080FUH
Segregation Form 3b	Horizontal top / bottom front	All	UC600FH	UC800FH
	Horizontal top / bottom back	Enclosure depth [mm] 400	UC6040BH	UC8040BH
		600	UC6060BH	UC8060BH
		800	UC6080BH	UC8080BH
	Horizontal top / bottom full depth	Enclosure depth [mm] 400	UC6040FUH	UC8040FUH
		600	UC6060FUH	UC8060FUH
		800	UC6080FUH	UC8080FUH
Rear Vertical	All	UC6020V	UC8020V	

3.7.8 Cable trunking

Easy wiring

To ease the wiring and increase aesthetics in the assembly cable trunking can be used. To fix the trunking on the structure, there are several possibilities - vertically they can be inserted in the side of the standard DIN rail kit, horizontally we suggest to use a support rail to avoid bending of the trunking due to wire's weight. Usage of plastic rivets for the fixation of the trunking is recommended.

Vertical support - included in kit **UCxxxxMD**

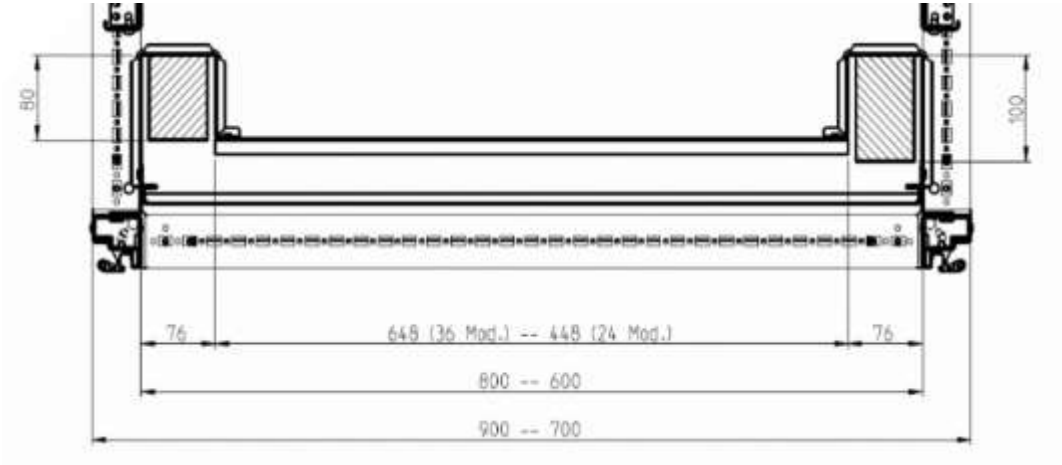

Horizontal support - UC915HS

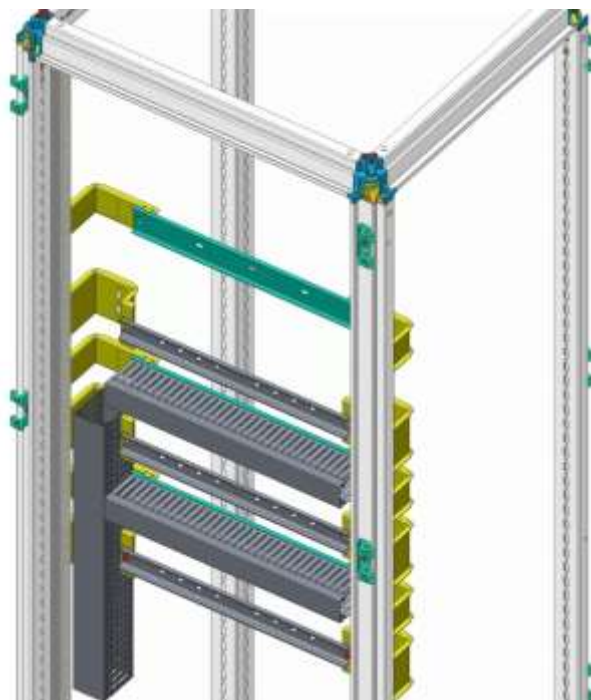

Cable trunking

cable trunking with cover, halogen free, 60 x 80 x 2000 mm grey RAL 7030	UC916
cable trunking with cover, halogen free, 30 x 80 x 500 mm grey RAL 7030	UC912
cable trunking with cover, halogen free, 30 x 80 x 750 mm grey RAL 7030	UC913

Wire guides

Wire guides are used without cable trunking, as alternative solution. The fixation is done on the rear of the quadro DIN rails.

Set of adapters to fix cable trunking on 15 mm DIN rail, 20 sets in packaging	UZ01V1
Set of clips to support cables, 1600 mm ² cross section	UZ25V2
Set of clips to support cables, 2200 mm ² cross section	UZ25V1

4 Planning and installation

Supplementary technical information for planners and manufacturers.

Chapter index

Standards, verifications and certificates	231
Protection classes for covers	240
Air clearances and creepage distances	243
Labelling and label panels	246
Protection against electric shock & continuity of protective conductor circuits	248
Implementing protective conductor and earthing connections in switchgear and controlgear assemblies	256
Installation of equipment	266
Internal electrical circuits and connections	269
Connections for conductors inserted from the outside	270
Insulation properties	272
Verification of short-circuit resistance	275
Verification of short-circuit resistance by applying the design rules	280
Short-circuit resistance of the protective conductor	281
Electromagnetic compatibility (EMC)	282
Mechanical function	284
Maintenance and assembly	285

4.1 Standards, verifications and certificates

Foreword

The international standards IEC 61439-1 / -2 have been accepted as European standards EN IEC 61439-1 / -2, therefore the implementation is identical.

Type test

The type test is carried out by Hager according to the “Low-voltage switchgear and controlgear assemblies” (SCA) series of standards:

- **IEC / EN IEC 61439-1:2021**
“Low-voltage switchgear and controlgear assemblies - Part 1: General rules”
- **IEC / EN IEC 61439-2:2021**
“Low-voltage switchgear and controlgear assemblies - Part 2: Power switchgear and controlgear assemblies”

Certificates

The information in the Hager catalogues, technical manuals and instruction leaflet is based on the VDE certificates for the quadro evo system.

Note

The following views are of a purely exemplary nature and are not subject to revision.



Design verification of quadro evo to I_{nA} 4000 A.
Tested and certified according to IEC / EN IEC 61439-1 / -2.

Design verification and routine verification according to IEC / EN IEC 61439

As the original manufacturer or according to the “original manufacturer” described in the IEC / EN IEC 61439-1 series of standards, Hager is responsible for performing the design verification of the switchgear and controlgear assembly by testing, calculation or by checking compliance with the design rules in accordance with IEC / EN IEC 61439.

Observe the following items when expanding or retrofitting the system:

- Each expansion or retrofitting measure must be planned. Observe the respective Hager guides and project planning guidelines as well as the manuals for the quadro evo enclosure types and components.
- Before replacing the electrical equipment with devices of a different type and before expanding the system in any way, the switchgear and controlgear assembly must be redesigned and checked in accordance with IEC / EN IEC 61439.
- When expanding or modifying an existing system, it must be verified and confirmed that the safety of the existing system is not adversely affected.

NOTICE

If the manufacturer of a switchgear and controlgear assembly makes changes to a system that are not included in the original manufacturer's design verification, this manufacturer becomes the original manufacturer.

This must also be observed when replacing or supplementing switchgear and equipment with components that are not identical in construction (made by different manufacturers).

4.1.1 Original manufacturer & SCA manufacturer

Explanation of terms

Standard IEC / EN IEC 61439 uses terms relating to the entities involved in the construction of low-voltage switchgear and controlgear assemblies, and assigns them clear responsibilities:

Original manufacturer

The original manufacturer is generally the producer of matching and tested system components, such as Hager, for example. The producer must provide the design verification through tests, calculations or by checking compliance with the design rules and must make this data available to the switchgear manufacturer as the basis for its calculation of the individually developed switchgear and controlgear assembly.

Switchgear and controlgear assembly manufacturer

The switchgear and controlgear assembly manufacturer is responsible for the system's solution design and therefore for the finished switchgear assembly. This is generally the switchgear manufacturer. This entity is responsible for dimensioning the system according to the agreed or tendered nominal data, for complying with the original manufacturer's design verification and calculating the system based on this information, for marking and documenting the installation and for carrying out the routine verification.

NOTE

The switchgear and controlgear assembly manufacturer may be a different entity than the original manufacturer.

4.1.2 Design verification according to IEC / EN IEC 61439

Requirements of the standard

The standard provides specifications in accordance with clause 8 ‘Construction requirements’ and clause 9 ‘Behavioural requirements’ for each low-voltage switchgear and controlgear assembly.

The fulfilment of these design and behavioural requirements must be verified and documented in a design verification.

The scope of the design verification is defined in clause 10 ‘Design verification’ of the standard.

General information

As the ‘original manufacturer’, Hager is obliged to provide the design verification required in clause 10 of the standard.

The design verification concerns the construction and behaviour of the switchgear and controlgear assembly as equipment.

Carrying out the design verification determines that the design of the low-voltage and controlgear assembly conforms to the requirements of the respectively applicable parts of the standard IEC / EN IEC 61439.

Subsequent modifications to low voltage switchgear and controlgear assemblies

If the manufacturer of the switchgear assembly (system builder) subsequently makes partial or complete modifications to a low-voltage switchgear and controlgear assembly for which a design verification exists, it must be checked in accordance with IEC / EN IEC 61439 clause 10 ‘Design verification’ whether these modifications impair the behaviour of the switchgear assembly. The design verification must be carried out again on the modified switchgear and controlgear assembly if an impairment is likely.

Design verification checklist according to IEC / EN IEC 61439

The following checklist contains a list of the design verifications carried out by Hager.

The checklist is structured in the same way as IEC / EN IEC 61439-1 (annex D, table D.1).

No.	Characteristics to be verified	Clause in the standard	Test	Comment
1	Strength of materials and parts	10.2	The mechanical, electrical and thermal suitability of the materials and parts used in the switchgear and controlgear assembly is considered to have been proven by verification of the construction and behavioural properties.	✓
	Corrosion resistance	10.2.2		✓
	Properties of insulation materials	10.2.3		✓
	Thermal resistance	10.2.3.1		✓
	Heat resistance of insulating materials against extraordinary heat and fire due to internal electrical influences	10.2.3.2		✓
	Resistance against ultraviolet (UV) radiation	10.2.4		✓
	Lifting	10.2.5		✓
	Impact test	10.2.6		✓

No.	Characteristics to be verified	Clause in the standard	Test	Comment
	Labelling	10.2.7		See the 'Labelling' clause in the technical manual
2	Protection class of covers	10.3	If no external changes have been made that could affect the protection class, no further testing is required.	✓
3	Air clearances	10.4	It must be verified that the air clearances and creepage distances meet the system requirements.	Air clearance ≥ 8 mm ($U_{imp} = 8$ kV)
4	Creepage distances	10.4		Creepage distance ≥ 11 mm ($U_i = 800$ V)
5	Protection against electric shock and continuity of protective circuits	10.5	Verification by checking or measuring resistance of the flawless connection between bodies of the switchgear and controlgear assembly and the protective conductor. The short-circuit resistance of the protective conductor circuit must be verified by the original manufacturer. This can be done by checking compliance with the design rules, calculation or testing.	Verification by measuring resistance
	Uniformity of the connection between bodies of the switchgear and controlgear assembly and the protective conductor circuit	10.5.2		
	Short-circuit resistance of the protective conductor circuit	10.5.3		
6	Installation of equipment	10.6	Compliance with the construction requirements for the installation of equipment must be verified by inspection.	Observe the requirements of the standard
7	Internal electrical circuits and connections	10.7	Compliance with the construction requirements for internal electrical circuits and connections must be verified by inspection.	
8	Connections for conductors inserted from the outside	10.8	Compliance with the construction requirements for connections inserted from the outside must be verified.	
9	Insulation properties	10.9	Compliance with the construction requirements must be verified.	
	Power-frequency withstand voltage	10.9.2		
	Impulse withstand voltage	10.9.3		
10	Temperature rise limits	10.10	It must be verified that the specified temperature rise limits of the parts of the switchgear and controlgear assembly are not exceeded.	Observe catalogue information, annexes of the certificate and the technical manual. Calculation methods are possible up to 1600 A.
11	Short-circuit resistance	10.11	The short-circuit resistance must be verified by checking compliance with the design rules/calculations/tests.	Observe catalogue information, annexes of the certificate and the technical manual
12	Electromagnetic compatibility (EMC)	10.12	The behaviour requirements for EMC must be confirmed by inspection or testing.	Observe the requirements of the standard

No.	Characteristics to be verified	Clause in the standard	Test	Comment
13	Mechanical function	10.13	This verification does not have to be provided if parts of the switchgear and controlgear assembly have already been tested according to the applicable regulations. For parts which require verification by testing, the flawless mechanical function must be verified after installation in the switchgear and controlgear assembly.	✓ Observe the catalogue information

✓ Hager has performed the verification by testing.

This test is not required for the installer/system manufacturer if Hager equipment is used in accordance with the design verification.

NOTE

This does not apply to the wiring or connected cables.

4.1.3 Routine verification according to IEC / EN IEC 61439

General information

Regardless of whether a low-voltage switchgear and controlgear assembly has been built according to IEC / EN IEC 61439-2 or to IEC / EN IEC 61439-3, a routine verification as described below must be performed.

The quadro evo system and equipment inside the quadro evo system are subject to design verifications.

However, these verifications do not prevent errors from creeping in, for example, during assembly or generally during the production process. For this reason, the final step is to carry out the routine verification to detect material and manufacturing defects and to ensure the correct functioning of the completed switchgear and controlgear assembly.

Routine testing must be carried out on each low voltage switchgear and controlgear assembly.

According to standard IEC / EN IEC 61439-1, it is not necessary to carry out routine verifications on devices installed in the low-voltage switchgear and controlgear assembly or on assemblies which can be used on their own if they have been correctly selected in accordance with clause 8.5.3 of the standard and installed according to the device manufacturer's instructions.

Scope of the routine test according to IEC / EN IEC 61439

With reference to IEC / EN IEC 61439-1 clause 11.1.a, the routine test must include the following points:

No.	Content of routine test	Clause in IEC / EN IEC 61439-1
1	Protection class of covers	11.2
2	Air clearances and creepage distances	11.3
3	Protection against electric shock and continuity of protective circuits	11.4
4	Installation of equipment	11.5
5	Internal electrical circuits and connections	11.6
6	Connections for conductors inserted from the outside	11.7
7	Mechanical function	11.8
8	Insulation properties	11.9
9	Wiring, operating behaviour and function	11.10

Protection class of covers

A visual inspection must be carried out to verify that the prescribed measures for achieving the intended protection class are observed. If no changes have been made to the enclosure and the system's construction instructions have been followed, no reduction of the covers is to be expected. This also applies to the system's interior fittings in terms of barriers and built-in equipment.

Air clearances and creepage distances

It must be checked whether the air clearances are greater than or equal to those specified in the documentation. In case of doubt, the impulse withstand voltage must be tested in accordance with the standard. If the air clearance is easily visible, the verification can be carried out via a simple physical measurement.

Compliance with the specifications regarding creepage distances must be verified by visual inspection. If this is not possible by visual inspection, the verification must be carried out by physical measurement.

Protection against electric shock and continuity of protective circuits

The prescribed measures with regard to basic protection and fault protection must be subjected to a visual inspection. The protective conductor circuits must be subjected to a visual inspection.

Screwed connections must be checked randomly to ensure that they are tightened correctly. This is especially important after transporting the switchgear.

Installation of equipment

It must be ensured that the installation and marking of the built-in equipment comply with the manufacturing documents for the switchgear and controlgear assembly.

Internal electrical circuits and connections

Connections, especially screwed connections, must be checked randomly to ensure that they are correctly tightened. Torques must correspond to the system or equipment documentation. Conductors or wiring must be checked for compliance with the manufacturing documents for the switchgear and controlgear assembly.

Connections for conductors inserted from the outside

The number, type and marking of connections must be checked for conformity with the switchgear and controlgear assembly's manufacturing documents.

Insulation properties

A test of the operating frequency insulation strength must be carried out on all circuits for 1 second in accordance with the following table.

Rated insulation voltage U_i : (conductor to earth) [V]	Test voltage: (AC-effective value) [V]
$U_i \leq 12$	250
$12 < U_i \leq 60$	500
$60 < U_i$	1000
$60 < U_i \leq 300$	1500
$300 < U_i \leq 690$	1890
$U_i = 800 \text{ V}$	2000

More information can be found in the standard.

NOTICE

The test is not required for auxiliary circuits

- which are protected by a short circuit protection device up to 16 A,
- if an electrical function test has previously been carried out at the rated operating voltage for which the auxiliary circuits are intended.

(Extract from IEC / EN IEC 61439-1)

Alternatively; for switchgear and controlgear assemblies with a protective device in the incoming unit, rated up to $I_{nA} = 250$ A, the insulation resistance can be verified by measurement using insulation measuring equipment with a voltage of at least 500 V DC.

In this case, the test is passed if the insulation resistance between the circuits and bodies is at least $1000 \Omega / V$ per circuit, related to the supply voltage of these circuits to earth.

Wiring, operating behaviour and function

Make sure that the information and markings are complete.

Depending on the complexity of the switchgear and controlgear assembly, it may be necessary to check the wiring and perform an electrical function test. The test procedure and number of tests depend on whether the switchgear and controlgear assembly has complicated locking mechanisms or sequence controls, etc.

(Extract from IEC / EN IEC 61439-1)

NOTE

In some cases, it may be necessary to perform or repeat this test on site before the system is put into operation.

4.2 Protection classes for covers

General information and nomenclature

General information

The protection class indicates the electrical equipment's suitability for use in different environmental conditions.

With regard to its suitability for use in various environmental conditions, electrical equipment is designed with suitable protection classes, expressed by IP codes.

In this document, the IP codes refer to standard DIN EN 60529 (VDE0470-1:2014-9) protection classes provided by enclosures.

Nomenclature

The letters 'IP' which are always present in the protection class designation, are followed by two code numbers. These numbers indicate the degree of protection provided by an enclosure with regard to contact or foreign bodies (first digit) and moisture or water (second digit). If one of the two numbers is not specified or does not have to be specified, it is replaced by the letter 'X' (for example 'IPX1').

If required, further defined letters can be added to the number combination to provide a more precise description of the protection class. Here, the third digit indicates the additional touch protection. The fourth digit is a supplementary letter. The last two digits are not mandatory.

4.2.1 Protection classes

Table of protection classes

First digit of the IP code: Protection against foreign bodies and contact

1st digit	Protection against foreign bodies
0	No protection
1	Protection against solid foreign bodies with diameter ≥ 50 mm
2	Protection against solid foreign bodies with diameter ≥ 12.5 mm
3	Protection against solid foreign bodies with diameter ≥ 2.5 mm
4	Protection against solid foreign bodies with diameter ≥ 1.0 mm
5	Protection against damaging quantities of dust
6	Dust-tight

Second digit of the IP code: Protection against water

2nd digit	Protection against foreign bodies
0	No protection
1	Protection against dripping water
2	Protection against water dripping vertically when the enclosure is tilted by up to 15°
3	Protection against dripping spray water up to 60° from the vertical
4	Protection against splash water from all sides
5	Protection against water jets (nozzles) from any angle
6	Protection against strong water jets
7	Protection against temporary immersion
8	Protection against permanent immersion
9	Protection against water at high pressure / steam jet cleaning, especially in an agricultural environment

Code letter for the third digit of the IP code: Access to dangerous live parts

Code letter	Access to dangerous live parts
A	Protection against access to dangerous live parts with the back of the hand . $\varnothing > 50$ mm
B	Protection against access to dangerous live parts with a finger . $\varnothing > 1$ mm and up to 80 mm long
C	Protection against access to dangerous live parts with a tool . $\varnothing > 2.5$ mm and up to 100 mm long
D	Protection against access to dangerous live parts with a wire . $\varnothing > 1$ mm and up to 1000 mm long

Code letter for the fourth digit of the IP code (optional according to DIN 60529)

Code letter	Can be used optionally
H	High voltage equipment
M	Tested when moving parts are in operation
S	Tested when moving parts are at standstill
W	Tested under specified weather conditions

Example

Protection type: IP54

IP code	Explanation of code letter	Explanation
IP	-	Ingress protection
5	Protection against foreign bodies and contact	Protection against damaging quantities of dust
4	Protection against water	Protection against splash water from all sides

Protection type: IP2xC

IP code	Explanation of code letter	Explanation
IP	-	Ingress protection
2	Protection against foreign bodies and contact	Protection against solid foreign bodies with diameter ≥ 12.5 mm.
x	Protection against water	Protection class not specified in this case because not necessary.
C	Access to dangerous live parts	Protection against access to dangerous live parts with a tool.

4.3 Air clearances and creepage distances

Definitions

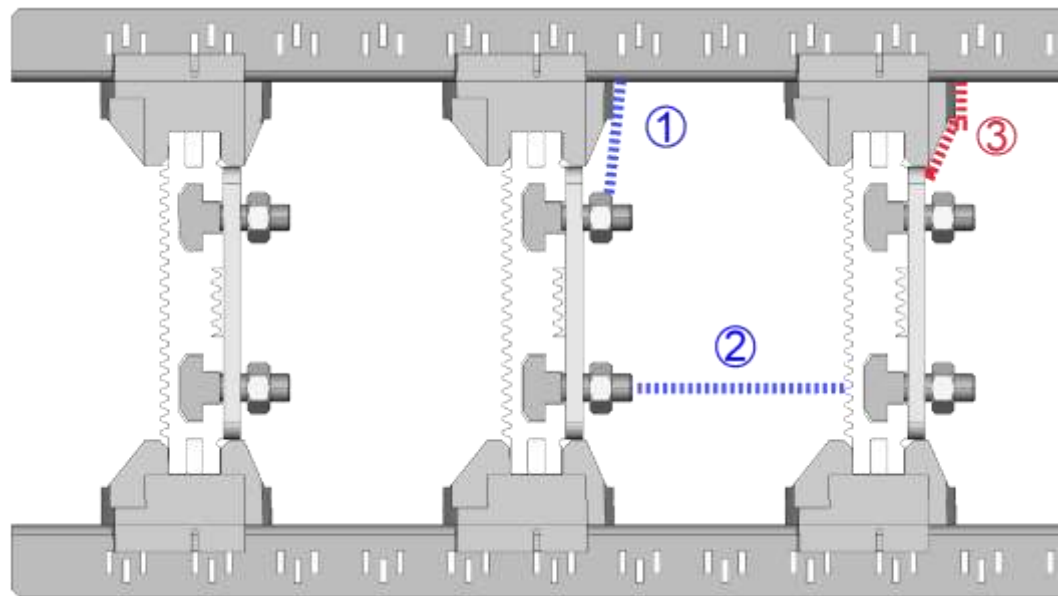

Air clearances and creepage distances

1 and 2 (blue)	Air clearances
3 (red)	creepage distance

Basic information

To dimension the air clearances and creepage distances, the following relationships result from the insulation coordination rules:

- Air clearances are dimensioned according to the expected overvoltages, taking into account the rated values of the surge protection device used and the ambient conditions to be expected, with consideration for the protective measures adopted against pollution.
- Creepage distances are dimensioned according to the working voltage and the expected ambient conditions, with consideration for the protective measures adopted against pollution and the insulating materials used.

Rated values for quadro evo

Rated operational voltages	3 AC 50 Hz 230 / 400 V
	3 AC 50 Hz 400 / 690 V
Rated current	For devices up to 4000 A
Rated insulation voltage	AC 400 V / 690 V
Rated peak withstand current	6 kV / 8 kV
Surge voltage category	IV
Degree of pollution	3
Air clearance	≥ 8 mm
Creepage distance	≥ 11 mm

NOTE

Air clearances and creepage distances can be reduced taking into consideration the requirements from IEC / EN IEC 61439-1, -2 (clauses 8.3.2, 8.3.3 and annex F). Hager recommends observing the values provided above as a basis. If these limits are reduced, the responsibility lies with the switchgear and controlgear assembly manufacturer.

Degree of pollution

According to IEC / EN IEC 61439-1 clause 7.1.3, the degree of pollution refers to the ambient conditions for which the low-voltage switchgear and controlgear assembly is intended. For the switchgear and components in an enclosure, the degree of pollution of the ambient conditions in the enclosure applies.

The following assignments apply to the degrees of pollution:

Degree of pollution 1

No pollution or only dry, non-conductive pollution occurs. The pollution has no influence.

Degree of pollution 2

Only non-conductive pollution occurs. Occasionally, temporary conductivity due to condensation must be expected.

Degree of pollution 3

Conductive pollution occurs or dry, non-conductive pollution that becomes conductive as condensation is expected.

Degree of pollution 4

The pollution leads to constant conductivity, e.g. caused by conductive dust, rain or snow.

NOTE

Pollution degree 4 does not apply to the micro-environment inside the switchgear and controlgear assembly pursuant to standard IEC / EN IEC 61439-1.

NOTE

Unless otherwise specified, pollution degree 3 applies to switchgear and controlgear assemblies used in industry. However, other degrees of pollution may be used depending on the application or micro-environment concerned.

Material groups

‘CTI’ - Comparative Tracking Index.

Numerical value of the highest voltage in volts at which a material can withstand 50 drops of a specified test liquid without tracking.

NOTE

The value of each test voltage and the ‘CTI’ must be divisible by 25.

The materials are divided into the following four groups according to their Comparative Tracking Index (CTI):

Material	CTI - Comparative Tracking Index
I	$600 \leq \text{CTI}$
II	$400 \leq \text{CTI} < 600$
IIIa	$175 \leq \text{CTI} < 400$
IIIb	$100 \leq \text{CTI} < 175$

The CTI values refer to the results determined for the insulation material according to IEC 60112:2003 + A1:2009, procedure A.

4.4 Labelling and label panels

Intended purpose

Type plates are used to identify the individual enclosure types and their traceability. They also contain product information required by the standards such as protection type and class, if applicable, as well as information about the approval by an external testing body (e.g. VDE).

Applicable documents

- DIN VDE 0603-1, clause 4.3 Labelling
- IEC / IEC EN 61439-1 clause 6.1 'Assembly designation marking'
- DIN EN ISO 9001:2008-2
- Feuille d'instructions no. 9Z 9031 00
- Hager Guidelines Visual Identity Grafic Code

Design of content (texts and symbols)

The labels and signs necessary for the product are determined by Hager.

As the use of the end product has not yet been defined when the device is delivered (meter board, type of low-voltage distribution), it is not possible to provide all the information required by the standards.

The contents specified by Hager are just the application-specific basic requirements.

NOTICE

The switchgear and controlgear assembly manufacturer must complete this information.

Type plates for basic enclosures



- Wipe-resistant (water and thinner according to IEC / EN IEC 61439-1)

The type plate indicates:

- Manufacturer's address
- Item number
- Certified product standard
- Protection class (IP) according to VDE certificate
- Product group description
- Symbols
- Protection class symbol
- Production date

Additional type plate of switchgear manufacturer

According to the applicable standard, the switchgear and controlgear assembly manufacturer must mark and document the switchgear and controlgear assembly. In the event that the systems are designed by switchgear manufacturer-partners in cooperation with the technical service, the following blank type plate of the switchgear manufacturer-partner will be delivered (delivery form: DIN A4 sheet with 4x blank type plates).

Power switchgear and controlgear assembly

Type _____

Rated current of the PSC (I_{N}) _____

Rated voltage of the PSC (U_n) _____ Project / Part _____

Type of current / frequency _____

Rated voltage of auxiliary circuits _____

Degree of protection _____ project code _____ Date _____

Standards: DIN EN 61439-1 (VDE 0660-600-1)

Before commissioning the switchgear assembly, all settings on protective devices must be checked in accordance with their protective function for the circuit concerned: if necessary, these settings must be carried out as intended.

TRIGEST19 / SMO11100

Installation verification sheets for basic enclosures (wall-mounted, standing, quadro eva modular stand-alone distributor)

All basic enclosures are supplied with the following illustrated sheet (DIN A4) for the installation verification. This must be filled in by the switchgear and controlgear assembly manufacturer and also installed in the enclosure, in the visible area.

:hager

Project name: _____

Type: _____

Max. system voltage: _____

Insulation voltage: _____

Rated current: _____

Degree of protection: _____

Frequency: _____

Type of current: _____

Standards: _____

VDE-AR-N: _____

Fachbereich: _____

Blatt 1: _____

Blatt 2: _____

Blatt 3: _____

Blatt 4: _____

Blatt 5: _____

Hersteller durch / installiert per / installiert by: _____

1	2	3	4	5	6	7	8	9	10	11	12	13	14	15	16	17	18	19	20	21	22	23	24	25	26	27	28	29	30	31	32	33	34	35	36	37	38
1	2	3	4	5	6	7	8	9	10	11	12	13	14	15	16	17	18	19	20	21	22	23	24	25	26	27	28	29	30	31	32	33	34	35	36	37	38

4.5 Protection against electric shock & continuity of protective conductor circuits

4.5.1 Basic definitions

Basic concept of protection against electric shock

When installing an electrical system, it must be ensured that, when the system is in a fault-free state, parts of the system that carry a current dangerous to humans cannot be touched. In the event of a fault which can lead to a life-threatening electric shock, suitable protective measures must be taken.

"Devices and circuits in a switchgear and controlgear assembly must be arranged in such a way that their operation and maintenance are facilitated and at the same time the necessary protection is ensured.

The following requirements are intended to ensure that the required protective measures are observed when a switchgear and controlgear assembly is connected to a system in accordance with standards of the IEC 80364 series.

Comment: for the generally applicable protective measures, IEC 61140 and IEC 60364-4-41 apply." (Quote e.g.: IEC / EN IEC 61439-1)

Basic definition - basic / fault protection

A protection measure always consists of a combination of two independent protective devices: the basic protection and the fault protection. Dangerous live parts must not be accessible or touchable under normal conditions. Furthermore, in the event of a fault, the occurrence of dangerous touch voltages on touchable conductive parts or surfaces is prevented.

Basic protection

Direct contact with live (active) parts of the electrical system is prevented e.g. through insulation.

Fault protection

In the event of a failure of the protective device for the basic protection, this prevents a dangerous touch voltage from occurring or remaining on conductive parts, e.g. by automatically disconnecting the power supply.

Additional protective devices

Additional protective devices provide protection:

- in the event of failure of the protective device used as the basic protection **and / or**
- in the event of failure of the protective device used as the fault protection **and / or**
- if the user of the electrical system is careless **or**
- in the event of particular danger to persons due to special conditions caused by external influences, e.g. through the use of error value protection devices with $I_{\Delta N} \leq 30 \text{ mA}$.

Safety measure to protect against electric shock according to DIN VDE 0100-410: 2007-06

- Clause 411: Automatic deactivation of the power supply
- Clause 412: Double or reinforced insulation
- Clause 413: Protective separation
- Clause 414: Safety extra-low voltage (SELV) or protected extra-low voltage with protective separation (PELV)

Implementation of the basic protection requirement in the quadro evo system

Implementation of the basic protection (protection against contact with active parts) is clearly described in standard IEC / EN IEC 61439-1 under clause 8.4.2.3 “Barriers or enclosures”:

Quote

“Air-insulated live parts shall be inside enclosures or behind barriers providing at least a degree of protection of IPXXB”

This required degree of protection is maintained by the Hager touch protection cover or the Hager enclosures and is confirmed by type tests.

Clause 8.4.2.3 “Barriers or enclosures” also mentions the following information:

Quote

“Where it is necessary to remove barriers or open enclosures or to remove parts of enclosures, this shall be possible only if one of the conditions a) to c) is fulfilled:

a) By the use of a key or tool, i.e. any mechanical aid, to open the door, cover or override an interlock.”

This requirement is also met by the Hager touch protection barrier using snap-lock bolts which can only be removed with a screwdriver, or by Hager enclosures equipped with a lock.

If no additional protection has been agreed between the system operator and the switchgear and controlgear assembly manufacturer, the measures described are sufficient to maintain the basic protection. See also IEC / EN IEC 61439-1 table C1.

NOTICE

If extended requirements for basic protection are agreed between the system operator and the SCA manufacturer, IEC / EN IEC 61439-1 clause 8.4.6.2.3 and table C.1 must be observed.



4.5.2 Protection classes

Definition

The protection classes are specified for all electrical equipment in DIN EN 61140:2016-11 (VDE 0140-1:2016-11).

Four protection classes exist for electrical equipment, whereby only protection classes one to three are permitted in the EU and other industrial countries.

These protection classes are to be distinguished from the IP-classified protection classes (IEC 60529). Whereas the three electrical equipment protection classes define measures to provide protection against voltages dangerous to the touch, IP protection classes describe the degree of protection of the enclosure against contact, foreign bodies and water.

Protection class	Symbol	Description
0	(no symbol)	Only basic insulation is used as the basic protection without a fault protection device.
I		Basic insulation is used as the basic protection, and a protective conductor connection is used as the fault protection. This means that all conductive parts of the enclosure of an item of equipment must be connected to a protective conductor system. Portable devices have a protective earth conductor which must be arranged in such a way that, in the event of a fault, the protective conductor is the last to be interrupted.
II		Basic insulation is used as the basic protection, and additional insulation is used as the fault protection. Protection class II devices are also known as 'double insulated devices'; the conductive parts of the enclosure have no earth connection. Portable devices do not have a protective earth conductor; only plugs with no safety contact are used.
III		The low voltage serves as the basic protection but there is no provision for fault protection. As with protection class II, equipment that operates with a low voltage requires reinforced or double insulation. The safety extra-low voltage (SELV) is max. 50 V for AC voltage and max. 120 V for DC voltage.

4.5.3 Network types

Overview of different network types

The maximum switch-off times for circuits in TN and TT systems with a nominal AC voltage of 230 / 400 V are shown graphically in the following overview.

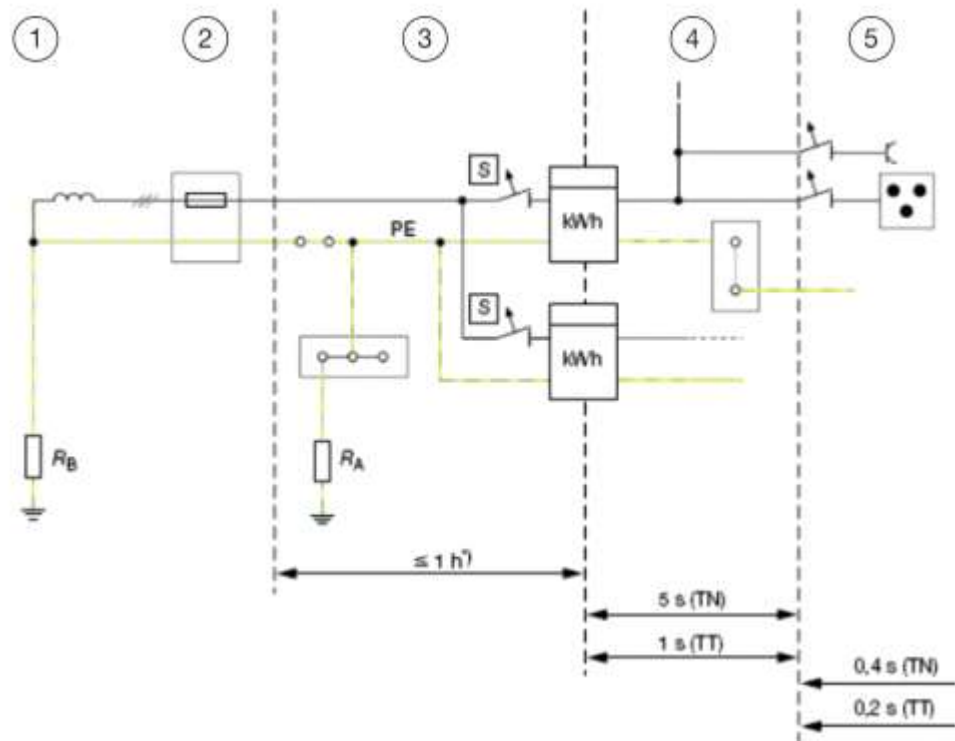

1	Public network 400 / 230 V
2	House consumer unit
3	Main power supply system (double or reinforced insulation)
4	Distribution circuit
5	Final circuit up to 32 A

For distribution networks designed as power lines or underground cables, as well as in primary power supply systems according to DIN 18015 - 1 with a “double or reinforced insulation” protective measure, it is sufficient if there is an overcurrent protection device at the start of the line section to be protected and, in the event of a fault, at least the current is flowing which causes the protective device to trip under the conditions specified in the standard for the overcurrent protective device for the overload range (large test current). This results in switch-off times of the overcurrent protection device of up to one hour.

TN system

A TN system is a specific way to implement a low voltage network in the electrical power supply. The most important feature is the type of earth connection of this power supply system to the power source and the electrical equipment in the building installation.

In a TN system, the star point is earthed on the undervoltage side of the supplying transformer.

In contrast to a TT system, in a TN system, the circuit is zeroed with the consumer's installation. In a TN system, there is a connection between the system (functional) earthing and the plant (protective) earthing.

In the event of sufficient low impedance, earth faults in TN networks lead to earth fault currents which cause the upstream fuse to respond. With a high-impedance earth fault, on the other hand, the earth fault current is often too low to trip the fuse. These earth currents, which are also known as 'residual currents', are particularly dangerous as they can lead to electrical accidents or equipment fires. To reduce this risk, residual current circuit breakers are used to detect high-impedance earth faults.

Depending on the design of the protective conductor, TN systems are divided into TN-C systems, TN-C-S systems and TN-S systems.

The TN-C-S system is the most common type of network in the low-voltage range. It is simple with a practical design, and proven in practice. For this reason, we will only refer to the TN-C-S system below.

TN-C-S system

The PEN conductor is divided into a protective conductor (PE) and a neutral conductor (N), preferably in the main power supply system.

After the transition to the TN-C-S system, the protective conductor (PE) and the neutral conductor (N) are kept strictly separated further along the line. It is not permitted, further along the line, to connect the neutral conductor to any other earthed part of the system or to reconnect it to the protective conductor.

TN-C-S system - fault: short to the enclosure

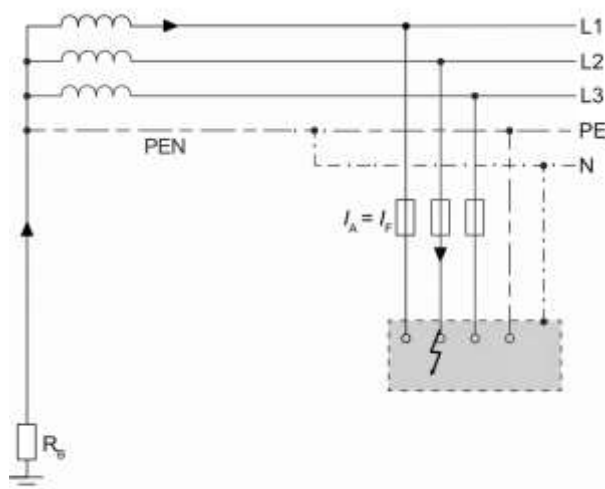

In the event of a short to the enclosure, the fault loop in the TN system is formed by an external conductor and the PEN or PE. The material, length and cross-section of the conductors are in most cases largely identical. For this reason, the resistances of the respective conductors are almost identical. Compared to the TT system, the system offers the advantage of a shorter switch-off time of the overcurrent protection devices due to the higher residual current.

Due to the significantly lower impedance of the PEN conductor compared to the operational earthing, a lower current flows via the system earthing itself despite the higher total residual current compared to TT systems.

$$I_f = \frac{U}{R} \quad \text{where } R \rightarrow 0 \quad I_f = \frac{U}{0} \quad I_F \rightarrow \infty$$

A short to the enclosure is therefore a non-critical fault as the switch-off condition for the overcurrent protection device is reached directly due to the high residual current.

However, due to the infinite current, it is necessary to design the protective conductor accordingly. But the residual current is limited by the fuse. The calculation formula for the copper conductor cross-section in relation to the NHgL fuse can be found in DIN VDE 0100 part 540.

To verify the effectiveness of the protective conductor circuit inside the switchgear and controlgear assembly, the resistance of the protective conductor circuit must not exceed 0.1 Ω (IEC / EN IEC 61439-1 / 10.5.2). The top-hat rail/mounting rail screw connection is tested for this. The enclosed wire is sufficient for the effective connection of the enclosure and the door to the earthing bar (continuity according to IEC / EN IEC 61439-1 / 10.5.2 verified). If devices with a higher voltage than low voltage are attached to the doors/enclosures, a protective conductor must be connected to these parts. In this case, the cross-section of the protective conductor must be in accordance with IEC / EN IEC 61439-1, table 3, with reference to the maximum rated operating current I_e of the secured equipment.

TN-C-S system - fault: earth fault

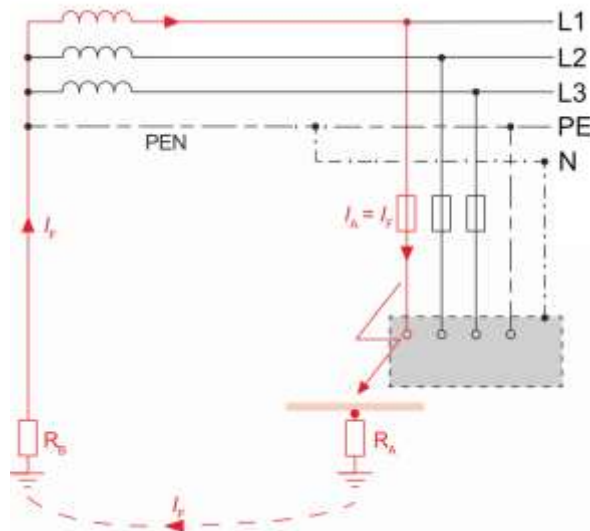

$$I_f = \frac{U}{R} \quad \text{with } R \rightarrow \infty \quad I_f = \frac{U}{0} \quad I_F \rightarrow 0$$

An earth fault in the TN system is particularly dangerous because the resistance of the earth fault is often highly resistive and the low residual current does not necessarily trip the upstream fuse. The switch-off condition $I_F \geq I_a$ is not achieved with a conventional overcurrent protection device. Strictly speaking, the switch-off condition for an earth fault is $I_F + I_B > I_A$. The resistance of the ground loop builds up a parallel circuit. The operating current I_B flows in one loop and I_F flows in the ground or fault circuit. Only if $R_B > R_F$ is the switch-off condition $I_F > I_A$ fulfilled.

NOTE

Sensitive monitoring by an RCD (residual current device) is required to detect and switch off the earth fault.

TT system

In the TT system, one point of the power source for the distribution network is connected to a system earth R_B . As in a TN system, the star point of the supplying transformer is usually earthed.

The protective conductor connected to the conductive enclosures of the electrical equipment in the consumer installation is not connected to the earthing of the distribution network, but is separately connected to its own local earth R_A (plant earth).

This lack of connection between the system earth of the generator and the earth of the consumer installations offers the advantage that no compensation currents can flow between the two earthing points because in the TT system, in contrast to the TN system, there is no increase in the earth potential due to the loaded PEN conductor on the consumer side. In the case of a system that has not been designed in accordance with the standards (no protective equipotential bonding conductors between external touchable parts such as water pipes and the main earthing bar), it is possible that compensating currents may flow between the plant earth and the system earth of the generator (secondary side, local network transformer) via directly earthed plants and systems, such as water pipes and other line networks (telecommunications, etc.), and cause them to corrode electrochemically over time.

TT system - fault

A short to the enclosure leads directly to an earth fault.

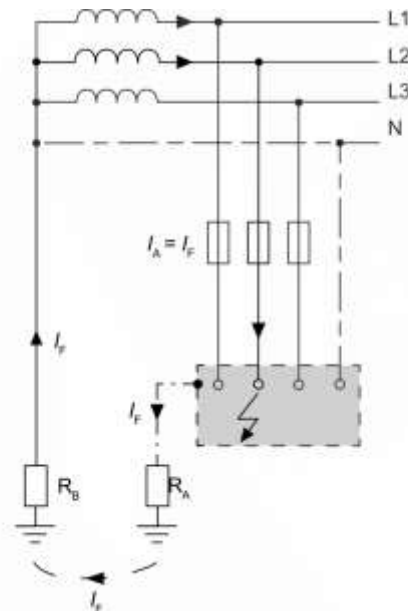

In the case of the TT system, the fault loop is formed by an external conductor and the path via R_A and R_B .

Here, the fault voltage corresponds approximately to the line-to-earth voltage U_0 because the resistance value of R_A is much higher than the sum of the remaining resistances in the fault circuit.

$$I_F = \frac{U_N}{R_A + R_B} \quad \text{where, e.g. } R_A = 5 \Omega, R_B = 5 \Omega, U_N = 230 \text{ V}$$

Thus, the following applies to the error voltage U:

$$U_F = R_A * I_F = 5\Omega * 23A = 115V = \frac{U_0}{2}$$

Thus, the error voltage exceeds the maximum permissible touch voltage and an immediate automatic switch-off becomes necessary. Via the switch-off condition $R_A \leq U_L / I_a$ where:

R_A = earth resistance of the bodies in Ω (ohm)

I_a = power in A which causes the protective device to switch off automatically

U_L = maximum permanent permissible contact voltage

$U_L \sim 50$ V, $U_L = 120$ V from DIN VDE 0100, Part 200

the value 1 Ω results for R_A already at a tripping current of 50 A.

Such small resistances for protective conductors are not economically feasible and the “protective earthing” protective measure alone is insufficient. Therefore, in the TT network, the RCD switch with a trip current of up to 300 mA is used. The calculation is based on a switch-off time of 0.2 s. The earth resistance when using an RCD should not exceed 200 Ω .

With the condition $R_A \leq U_L / I_{\Delta N}$ with e.g. $I_{\Delta N} = 300$ mA, $R_A = 166.6$ Ω .

NOTICE

In the event of a fault inside the switchgear and controlgear assembly, the rule also applies that the resistance of the protective conductor circuit must not exceed 0.1 Ω .

4.6 Implementing protective conductor and earthing connections in switchgear and controlgear assemblies

4.6.1 General information

Distinguishing between protective conductor connections- and earth connections

Inside the switchgear and controlgear assembly, a distinction is made between protective conductor connections and earth connections.

Protective conductor connection

This includes all active parts that are used to establish the connection between the protective conductor of the incoming unit and the protective conductor of the outgoing circuits.

It must be ensured that this connection is not interrupted when the covers are removed (e.g. to perform maintenance work). The requirements from clause 43.4 'Short-circuit resistance of the protective conductor' must be observed for protective conductor connections.

The design of the protective conductor connection depends on the supply current I_{nA} of the switchgear and controlgear assembly.

Protective conductor connections - cross-sections for protective conductors (PE, PEN):

Cross-section of the external conductor S	Minimum cross-section of the corresponding protective conductor (PE, PEN) Sp
$S \leq 16 \text{ mm}^2$	S
$16 \text{ mm}^2 < S \leq 35 \text{ mm}^2$	16 mm ²
$35 \text{ mm}^2 < S \leq 400 \text{ mm}^2$	S/2
$400 \text{ mm}^2 < S \leq 800 \text{ mm}^2$	200 mm ²
$800 \text{ mm}^2 < S$	S/4

Earth connection

This includes all inactive conducting parts such as covers, mounting rails, top-hat rails, etc. which do not have a protective conductor connection between the protective conductor of the incoming unit and the protective conductor of the outgoing circuits. These parts must be earthed separately or connected to the protective conductor via the construction type.

The transition resistance of this earthing connection (last construction part and protective conductor of the incoming unit) must not exceed 0.1 Ω.

The design of the earthing connection to the equipment and mechanical components of the system depends on the type of enclosure.

Earth connections - cross-sections for copper connecting conductors:

Rated operating current I_e	Minimum cross-section for connecting conductors
$I_e \leq 20 \text{ A}$	Cross-section of external conductor S in mm ²
$20 < I_e \leq 25 \text{ A}$	2.5 mm ²
$25 < I_e \leq 32 \text{ A}$	4 mm ²
$32 < I_e \leq 63 \text{ A}$	6 mm ²
$63 \text{ A} < I_e$	10 mm ²

Selecting components for earth and protective conductor connections

The following overview facilitates rapid selection of the required components, depending on the supply current I_{nA} and the type of enclosure.

	Modular stand-alone distributor FG
I_{nA} to 630 A: - Protective conductor connection - Earthing connection	Protective conductor measures for rated currents up to 630 A Earthing connection to quadro evo modular stand-alone distributors (630 A)
I_{nA} to 4000 A: - Protective conductor connection - Earthing connection	Protective conductor measures for rated currents up to 1600 A Earthing connection to quadro evo modular stand-alone distributors (1600 A)
Special cases: - $I_{nA} \leq 63$ A - Functional earthing VDI	Protective conductor measures for rated currents (< 63 A) -

4.6.2 Earthing connection in quadro evo modular stand-alone distributors for rated currents ≤ 250 A

Earthing connection for interior fittings

When using earthed system modules and a PE rail with an appropriate cross-section, no further earthing of the enclosure frame is necessary due to the mounting rails inside the enclosure. Furthermore, one or more protective conductor terminal blocks with an appropriate cross-section are sufficient as a support point for the earthing connection of the interior fittings.

If the protective conductor connection is isolated from the mounting rails, the enclosure frame must be connected to the central protective conductor at one point.

4.6.3 Protective conductor measures for rated currents ≤ 630 A

3 variants of connecting

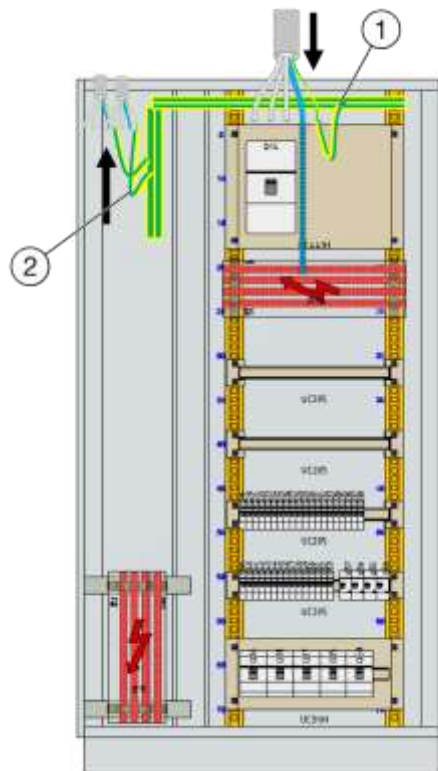

- | | |
|---|----------------------|
| 1 | Connection variant 1 |
| 2 | Connection variant 2 |

Variant 1

A perforated copper busbar, which is screwed directly to the enclosure frame, is used as the central protective conductor. The dimensions of the Cu busbar must be designed according to the incoming unit's external conductors pursuant to the table in chapter 'Assignment of minimum cross-sections'.

The contact of the incoming unit's protective conductor is ensured directly on the Cu busbar.

Variant 2

For smaller outgoing circuits that are routed via terminal blocks, one protective conductor terminal block is required per top-hat rail with outgoing terminal blocks for the protective conductor connection (e.g. KYA...). Both the terminal block and the wiring to the Cu busbar must be designed according to the technical values of the outgoing circuits. Here, the value of the rated short-time withstand current for quadro evo top-hat rails pursuant to the table in chapter 'Using top-hat rails as protective conductor busbars' must be observed in particular.

Variant 3

For larger outgoing circuits, where variant 2 is not possible due to the technical conditions, the protective conductor connection of the outgoing circuit must be directly connected to the Cu busbar.

4.6.4 Earthing connection in quadro evo modular stand-alone distributors for rated currents ≤ 630 A

Earthing connection for interior fittings

As in the current range from 630 A the central protective conductor is usually screwed directly to the enclosure frame, an additional earthing connection of the enclosure frame and the system modules is not necessary.

For quadro evo stand-alone distributors, the separately required earthing connection (10 mm²) to the side walls must be ensured.

4.6.5 Protective conductor measures for rated currents > 630 A

Central protective conductor

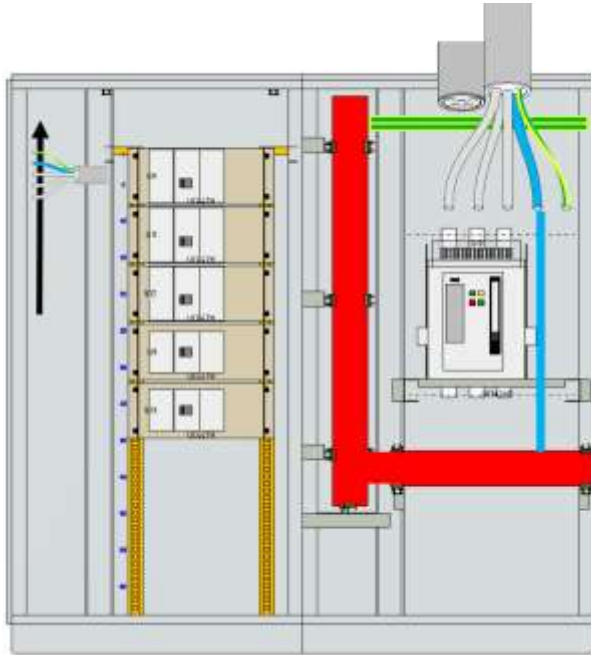

Protective conductor measures $I_{NA} \leq 1600 \text{ A}$

A copper busbar, to be placed directly at the supply point, is used as the central protective conductor. It can also be routed through the complete switchgear, even in the case of subdivided enclosures. The protective conductor of the incoming unit is connected directly to the Cu busbar.

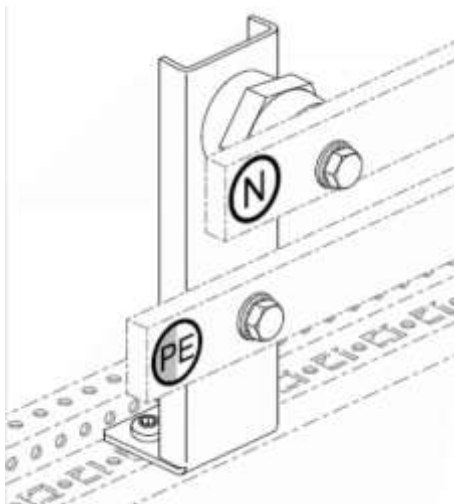

For smaller outgoing circuits that are routed via terminal blocks, one protective conductor terminal block is required for each top-hat rail with outgoing terminal blocks for the protective conductor connection (e.g. KYA...). Both the terminal block and the wiring to the copper busbar of the central protective conductor must be designed according to the technical values of the outgoing circuits.

Here, the value of the rated short-time withstand current for quadro evo top-hat rails must be observed in particular.

4.6.6 Earthing connection in quadro evo modular stand-alone distributors for rated currents > 630 A

Earthing connection for interior fittings

Due to the use of the UST42PEN as a busbar support for the central protective conductor, no further earthing measures are necessary with regard to the support frame and the enclosure structure. An additional earthing connection from the central protective conductor to the enclosure frame is only required if the copper busbar of the central protective conductor is insulated from the UST42PEN by additional supporting insulators (not included in delivery).

4.6.7 Assignment of minimum cross-sections

Minimum cross-sections

Assignment of minimum cross-sections of separately routed, mechanically unprotected PE conductors to the corresponding external conductor cross-sections.

If non-insulated PE conductors are used, the plastic insulation must not be touched.

Protective device: NHgL fuse ⁽¹⁾	PVC-insulated copper external conductor ⁽¹⁾	The smallest associated protective conductor cross-section made of copper (mechanically unprotected, laid separately as an individual conductor)			Non-insulated wire ⁽⁴⁾
		PVC insulated ⁽²⁾	Insulated as an external conductor ⁽³⁾	Not insulated ⁽⁴⁾	
I_N [A]	S [mm²]	S [mm²]	S [mm²]	S [mm²]	S [mm²]
16	1.5		1.5		25
20	2.5		2.5		25
25	4		4		25
35	6		6		25
50	10		10		25
63	16		16		25
80	25		16		25
100	35		16		25
125	50		25		25
160	70		35		25
200	95	20.3 (25)	47.5	18.3 (25)	25
250	120	26.6 (35)	60	23.9 (25)	25
250	150	26.6 (35)	75	23.9 (25)	25
315	185	32.8 (35)	92.5	29.5 (35)	2 x 25
355	240	39.9 (50)	120	35.9 (50)	2 x 25
400	300	43.8 (50)	150	39.4 (50)	2 x 25
500	400	59.4 (70)	200	53.4 (70)	3 x 25
630	500	78.2 (95)	200	70.3 (70)	3 x 25

1) PVC-insulated cable (30 °C) group 2 (DIN VDE 0100 T.523, assignment of gL fuses)

2) Calculated values for PVC-insulated PE according to DIN VDE 0100 T. 540 / 11.91 and rounding up to the next possible cross-section (values in brackets)

3) Minimum values for protective conductors with the same insulation material as the external conductor according to table 4, VDE 0660 T. 600 (IEC / EN IEC 61439-2) / VDE 0660 T.504 (IEC / DIN EN 61439-3)

4) Calculated values for bare mechanical, unprotected copper conductors according to DIN VDE 0100 T.540 / 11.91 and rounding up (values in brackets)

4.6.8 Protective conductor (PE)

Protective conductor cross-section of the assembly

IEC / EN IEC 61439-1 stipulates that each assembly must have a protective conductor for automatic power cut-off. This must be able to withstand the dynamic and thermal stresses caused by faults inside the enclosure and in feed circuits.

This protective conductor is often provided by a copper bar securely fastened to the enclosure framework and easily accessible for feed connections.

IEC / EN IEC 61439-1 Annex B specifies the calculation method for the protective conductor,

$$Sp = \frac{\sqrt{I^2 \times t}}{K}$$

- 'Sp' is the protective conductor cross-sectional area PE in mm²
- 'I²' is the effective fault current value in amps, line-to-earth, which is 60 % of the line-to-line fault current according to clause 10.11.5.6.
- 't' is the trip time of the breaking device in seconds (from min. 0.2 s to max. 5 s)
- 'k' is a factor based on the material type used

For example, the PE for an assembly with an I_{cw} characteristic of 50 kA / 1 s would be calculated as,

$$Sp = \frac{\sqrt{(50000 \times 0.6)^2 \times 1}}{176} = 170.45 \sim 171 \text{ mm}^2 \text{ with a 40/5 Cu bar}$$

(k = 176 for a bare copper bar)

Protective earth cross-section for feeds

Based on calculated values, use the standard PE bars dimensions as defined below. Hager offers perforated PE bars, that are easy to wire and to fix on the structure.

I _{cp} [A]	I _{cp} PE (I _{cp} *60 %) [A]	t [s]	k	cross section required [mm ²]	suitable standard [mm]	reference of perforated copper bar
85000	51000	1	176	289.77	63 x 5	UC922
75000	45000	1	176	255.68	63 x 5	UC922
70000	42000	1	176	238.64	50 x 5	UC844
65000	39000	1	176	221.60	50 x 5	UC844
52000	31200	1	176	177.23	50 x 5	UC844
40000	24000	1	176	136.37	32 x 5	UC843
35000	21000	1	176	119.32	25 x 5	UT87E
30000	18000	1	176	103.27	25 x 5	UT87E
25000	15000	1	176	85.23	25 x 5	UT87E
15000	9000	1	176	51.14	25 x 5	UT87E

4.6.9 Using top-hat rails as protective conductor busbars

Standardised top-hat rails as protective conductor busbars

According to DIN VDE 0611 T.3 / 11.89 para. 3.1.1, standardised rails (including top-hat rails according to DIN EN 60715) may be used as protective conductor busbars if the values of the rated short-time withstand current specified in the following table are not exceeded.

Top-hat rails according to DIN EN 60715 - steel	Corresponds to an E-Cu conductor with cross-section	Rated short-time withstand current I_{cw} (1 s) / kA
35 x 7.5 mm	16 mm ²	1.92
35 x 15 mm	50 mm ²	6

Exception:

Protective conductor busbars made of steel may not be used as PEN conductors or N conductors. For this reason, the table for steel rails does not indicate a maximum permissible rated current for the PEN function.

Hager device mounting rails made of steel comply with DIN EN 60715. Use is only permitted for the PE function and not for the PEN or N function.

4.7 Installation of equipment

General information

The installation of equipment is regulated by IEC / EN IEC 61439-1, clause 8.5 'Installation of equipment'.

Clause 8.5 'Installation of equipment' covers the following subjects:

- Clause 8.5.1 'Inserts'
- Clause 8.5.2 'Removable parts'
- Clause 8.5.3 'Choice of equipment'
- Clause 8.5.4 'Installation of equipment'
- Clause 8.5.5 'Accessibility'
- Clause 8.5.6 'Barriers'
- Clause 8.5.7 'Direction of actuation and indicating switch positions'
- Clause 8.5.8 'Indicator lights and push buttons'

4.7.1 Inserts

Installing inserts

With inserts (IEC / EN IEC 61439-1 clause 3.2.1), the connections of the main circuits (IEC / EN IEC 61439-1 clause 3.1.3) may only be connected or disconnected if the switchgear and controlgear assembly is de-energised. These inserts can generally only be removed and attached with tools.

To remove an insert, all or part of the switchgear and controlgear assembly must be disconnected from the mains.

To prevent unauthorised operation, the switchgear may be provided with arrangements to secure it in one or more of its positions.

4.7.2 Removable parts

Design of removable parts

Removable parts must be designed so that the installed electrical equipment can be safely disconnected or connected to the main circuit while live.

Removable parts may be equipped with an encoder (IEC / EN IEC 61439-1 clause 3.2.5).

A removable part must be fitted with a device which ensures that it can only be removed or inserted after its main circuit has been disconnected from the load.

Removable parts must have an operating position (IEC / EN IEC 61439-1 clause 3.2.3) and a set-down position (IEC / EN IEC 61439-1 clause 3.2.4).

4.7.3 Selecting the equipment

Equipment in accordance with the IEC standards

The equipment built into switchgear and controlgear assemblies must comply with the IEC standards applicable to them.

The equipment must be suitable for the application in question with regard to the external design of the switchgear and controlgear assembly (e.g. open or closed), its rated voltages, rated currents, rated frequency, service life, making and breaking capacity, short-circuit strength, etc.

If the short-circuit strength and / or breaking capacity of the equipment is not sufficient for the demands to be expected at the installation site, it must be protected by current-limiting protective devices such as fuses or circuit breakers.

When selecting current-limiting protective devices for built-in switchgear, the maximum permissible values specified by the device manufacturer must be taken into account; attention must be paid to the coordination of equipment (IEC / EN IEC 61439-1 clause 9.3.4).

The coordination of equipment, e.g. the coordination of motor starters with short-circuit protection devices, must comply with the applicable IEC standards.

In some cases, overvoltage protection may be required, e.g. for equipment that fulfils overvoltage category 2 (IEC / EN IEC 61439-1 clause 3.6.11).

4.7.4 Installation of equipment

Installation of equipment in accordance with the manufacturer's specifications

Equipment must be installed and wired in the switchgear and controlgear assembly in accordance with the manufacturer's specifications in such a way that influences, e.g. heat, switching emissions, vibrations, magnetic fields, which occur during normal operation, do not prevent it from functioning flawlessly. For switchgear and controlgear assemblies with electronic equipment, it may be necessary to separate or shield all electronic signal-processing circuits.

If any fuses are installed, the original manufacturer must specify the type and ratings of the fuse links to be used.

4.7.5 Accessibility

Allow easy access

Adjustment and reset devices which must be operated within the switchgear and controlgear assembly must be easily accessible.

Functional units mounted on the same supporting structure (mounting plate, mounting frame) and their connections for conductors inserted from the outside must be arranged in such a way that they are accessible for mounting, connection of the conductors, maintenance and replacement.

Unless otherwise agreed between the switchgear and controlgear assembly manufacturer and the user, the following accessibility requirements apply in connection with switchgear and controlgear assemblies installed on the floor:

- Apart from protective conductor connections, connections must be arranged at least 0.2 m above the base of the switchgear and controlgear assembly in such a way that cables and lines can be easily connected.
- Displays that must be read by the operator must be arranged in a range between 0.2 m and 2.2 m above the base of the switchgear and controlgear assembly.
- Operating elements, e.g. handles, push buttons or similar, must be arranged at a height such that they can be easily operated, i.e. their centre line must lie between 0.2 m and 2 m above the base of the switchgear and controlgear assembly.
- Actuating elements for emergency stop devices (see IEC 60364-5-53, 536.4.2) must be mounted in an accessible area between 0.8 m and 1.6 m above the base of the switchgear and controlgear assembly.

4.7.6 Barriers

Barriers are protecting

Barriers for manually-operated switchgear must be arranged so that operators are not endangered by switching emissions.

To reduce the risk of danger when replacing fuse links, phase separators should be used unless this is unnecessary due to the design and arrangement of the fuses.

4.7.7 Direction of actuation and indicating switch positions

Clear indication

The operating positions of equipment must be clearly indicated. If the direction of actuation does not comply with IEC 60447, the direction of actuation must be clearly marked.

4.7.8 Indicator lights and push buttons

Colors accordingly with IEC 60073

Unless otherwise specified in the applicable product standard, the colours of indicator lights and push buttons must comply with IEC 60073.

4.8 Internal electrical circuits and connections

Inspection and verification

Compliance with the construction requirements of (IEC / EN IEC 61439-, clause 8.6) for internal electrical circuits and connections must be confirmed by inspection and verified according to this standard.

Connections, especially screwed connections, must be checked randomly to ensure that they are correctly tightened. Conductors must be checked for compliance with the manufacturing documents for the switchgear and controlgear assembly.

4.9 Connections for conductors inserted from the outside

General information

The switchgear and controlgear assembly manufacturer must specify whether the connections are suitable for copper or aluminium conductors or for both materials. The connections must be designed in such a way that the conductors inserted from the outside can be connected by means of screws, plug connections, etc., and it must be ensured that the contact force required for the current rating and the short-circuit resistance of the equipment and the circuit is maintained.

Unless special agreements have been arranged between the switchgear and controlgear assembly manufacturer and the user, the connections must be able to accommodate copper conductors from the smallest to the largest cross-section, assigned to the rated current (IEC / EN IEC 61439-1 annex A).

If aluminium conductors are to be connected, the type, size and connection method of the conductors must be designed in accordance with the agreement between the switchgear and controlgear assembly manufacturer and the user.

IEC / EN IEC 61439-1 table A.1 does not apply to the connection of conductors inserted from the outside for electronic circuits with low currents and low voltages (less than 1 A and less than AC 50 V or DC 120 V) to a switchgear and controlgear assembly.

The available connection space must allow proper connection of the specified conductors inserted from the outside and, in the case of multi-core cables/lines, splicing of the cores.

Comment 1

In the United States of America (USA) and in Mexico, the National Electrical Codes must be used to determine the required minimum wiring space. In the USA, NFPA 70, article 312 is applicable. In Mexico, NOM-001-SEDE is applicable. In Canada, the space for connecting and bending wires is defined in the Canadian Electrical Code, Part 2 Standard, C22.2 No. 0.12, Wire Space and Wire Bending Space in Enclosures for Equipment Rated 750 V or Less.

The conductors must not be subjected to any loads that could reduce their normal service life expectancy.

Unless otherwise agreed between the switchgear and controlgear assembly manufacturer and the user, in three-phase circuits with a neutral conductor, it must be possible to connect copper conductors with the following current carrying capacity to the terminals for the neutral conductor:

- half the current carrying capacity of the external conductor, if this is greater than 16 mm²; however, minimum value of the neutral conductor 16 mm²;
- with the same current carrying capacity as the external conductor if its cross-section is equal to or smaller than 16 mm².

Comment 2

When using conductor material other than copper, the above-mentioned conductor cross-sections should be replaced by cross-sections with equivalent conductivity; in this case, connections for larger cross-sections may be necessary.

Comment 3

In certain applications where the current in the neutral conductor can assume a high value, e.g. large lighting installations with fluorescent tubes, a neutral conductor with a current carrying capacity equal to or greater than that of the phase conductors may be necessary; this must be specially agreed between the switchgear and controlgear assembly manufacturer and the user.

Connections provided for incoming and outgoing neutral conductors, protective conductors and PEN conductors must be arranged near the corresponding external conductor connections.

Openings in cable/line entries, end plates, etc. must be designed in such a way that, after proper installation of the cables/lines, the intended protection measures against contact and the intended protection class are achieved. This requires use of the means of insertion specified by the switchgear and controlgear assembly manufacturer for the application concerned.

Connections for protective conductors brought in from outside must be marked according to IEC 60445. An example is the symbol reg. no. 5019 according to IEC 60417. This symbol may be omitted if the protective conductor brought in from the outside is connected to an internal protective conductor which is clearly marked with the colours green and yellow.

The connections for external protective conductors (PE, PEN) and for metal sheaths of cables/lines (steel installation pipe, lead sheath, etc.) must have a clean contact if necessary. Unless otherwise specified, they must be suitable for connecting copper conductors. A separate connection of a suitable size must be provided for the protective conductor of each outgoing circuit.

Unless otherwise agreed between the switchgear and controlgear assembly manufacturer and the user, terminals for protective conductors must be suitable for connecting copper conductors with a cross-section based on the cross-section of the corresponding external conductor according to (IEC / EN IEC 61439-1 table 5).

Special attention must be paid to the risk of electrolytic corrosion in the case of sheathings and conductors made of aluminium or aluminium alloys. The means of connection that ensure the continuous connection of the conductive parts with the external protective conductor must not have any other function.

Comment 4

Special precautions may be necessary for metal parts of the switchgear and controlgear assembly, in particular cable entry plates, if they have a particularly resistant surface, for example powder coating.

‘Unless otherwise specified, the marking of connections must comply with IEC 60445.’

(Quote: IEC / EN IEC 61439-1, clause 8.8)

‘Compliance with the construction requirements (IEC / EN IEC 61439-1 clause 8.8) for connections for conductors inserted from the outside must be confirmed by inspection.’

(Quote: IEC / EN IEC 61439-1, clause 10.8)

‘The number, type and marking of connections must be checked for conformity with the switchgear and controlgear assembly’s manufacturing documents.’

(Quote: IEC / EN IEC 61439-1, clause 11.7)

4.10 Insulation properties

Power-frequency withstand voltage

The circuits of a switchgear and controlgear assembly must have the appropriate operating frequency withstand voltage. The rated peak withstand current of each circuit of a switchgear and controlgear assembly must be greater than or equal to the highest operating voltage. To ensure this, the data sheets of the equipment and the additional documentation of the connection technology must be observed.

Impulse withstand voltage

Impulse withstand voltage of main circuits

Air clearances between active parts and bodies of the switchgear and controlgear assembly and air clearances between active parts of different potentials must be able to withstand the required test voltage according to the values of the rated peak withstand current apparent in the standard, depending on the installation situation.

These values must be observed when selecting equipment.

Impulse withstand voltage of auxiliary circuits

'Auxiliary circuits which are connected to the main circuit and operated with its rated operating voltage and without additional measures to reduce overvoltages must meet the requirements of IEC / EN IEC 61439-1, clause 9.1.3.1.

Auxiliary circuits that are not connected to the main circuit may have a different overvoltage resistance than the main circuit. Air clearances of such circuits, AC or DC, must have the corresponding impulse withstand voltage according to annex G of IEC / EN IEC 61439-1.' (Quote: IEC / EN IEC 61439-1, clause 9.1.3.2)

To facilitate the planning of the switchgear and controlgear assembly, the following tables provide examples of the impulse withstand voltage of certain switchgear. For detailed data, refer to the equipment's documentation.

		Insulation voltage [U _i]	Impulse withstand voltage [U _{imp}]	Ambient operating temperature
	6 kA, 6...63 A	500 V	4000 V	-25...60 °C
	10 & 15 kA, 6...125 A	500 V	6000 V	-25...60 °C
	6 & 10 kA, 6...32 A	500 V	6000 V	-25...40 °C

		Insulation voltage [U _i]	Impulse withstand voltage [U _{imp}]	Ambient operating temperature
RCD 	16...63 A	500 V	6000 V	-25...40 °C
SLS 	16...100 A	690 V	6000 V	-25...40 °C
NH fuse switch disconnecter 	63...630 A	1000 V	8000 V	-25...60 °C
NH fuse switch 	63...630 A	800 V	8000 V	-25...55 °C
MCCB 	P160 / P250 / P630	800 V	8000 V	-20...70 °C
	h1000...h1600	800 V	6000 V	-20...70 °C
RCD 	160...630 A	690 V	6000 V	-20...70 °C
Disconnecter 	HAB, -C, -D, -E 20...160 A	800 V	8000 V	-20...70 °C
	h160	600 V	6000 V	-20...70 °C
	h250...h1600	800 V	8000 V	-20...70 °C

Switch disconnect
or / Automatic tra
nsfer switch



		Insulation voltage [U_i]	Impulse with- stand voltage [U_{imp}]	Ambient operating temperature
	HIM... top-hat rail 20...80 A	800 V	8000 V	-20...70 °C
	Top-hat rail 63...125 A	800 V	8000 V	-20...70 °C
	Mounting pla- te 125...400 A	800 V	8000 V	-20...70 °C
	Mounting pla- te 630...1600 A	1000 V	12000 V	-20...70 °C

4.11 Verification of short-circuit resistance

General explanation of terms

A short-circuit current is an overcurrent which occurs as a result of the incorrect bridging of parts of the normal circuit impedance. This can occur at different points in the electrical circuit and depends on the power supply side, the circuit impedance itself and any short-circuit protection devices that may be present. The level of the short-circuit current can be influenced by short-circuit protection devices installed in the switchgear and controlgear assembly or upstream. Therefore, the level and duration of the fault that must be considered always depends on the conditions in the location under consideration.

The switchgear and controlgear assembly must be designed in such a way that it can withstand the thermal loads caused by losses in the current path converted into heat and the dynamic load, essentially caused by the surge short-circuit current in a short circuit.

The switchgear and controlgear assembly manufacturer is responsible for verifying short-circuit resistance.

The IEC / EN IEC 61439 series of standards discusses all switchgear combinations and therefore covers all possible current-limiting or non-current-limiting applications, with or without protective devices. For this reason, the specifications for the switchgear and controlgear assembly require that, if applicable, all the characteristic features of interfaces (in accordance with clause 5 of the standard) must be included in the technical documentation provided by the switchgear and controlgear assembly manufacturer, supplied with the switchgear and controlgear assembly.

The documentation relating to short-circuit resistance is based on the rated values:

- I_{pk} : rated peak withstand current
- I_{cc} : rated conditional short-circuit resistance
- I_{cw} : rated short-circuit resistance together with the associated duration

The short-circuit protection devices used must also be described. Thus, the technical descriptions regarding short-circuit protection and short-circuit resistance are provided.

The rated values to be specified depend on the design of the switchgear and controlgear assembly, i.e. of the individual solution. The applicable design values must be specified for this solution. If no current-limiting switchgear is included in the supply circuit of a switchgear and controlgear assembly, the switchgear and controlgear assembly must be designed for the highest possible surge short-circuit current that can occur at the connection point. This rated peak withstand current I_{pk} must be verified and in this case, an important interface characteristic must be specified.

This means that the highest dynamic load on the switchgear and controlgear assembly has been tested. The highest thermal load is determined by the effective value of the short-circuit current and the duration. The ratio between the surge short-circuit current and the effective value of the continuous short circuit current is given by the factor "n" which can be found in table 7 of the standard. Thus, the rated short-time withstand current I_{cw} is the second value to be specified as an interface characteristic for these applications.

In most applications, there is a short circuit protection device (SCPD) in the circuits. For these applications, the rated conditional short-circuit current I_{cc} must be verified and specified. The I_{cc} must also be at least as large as the uninfluenced short-circuit current I_{cp} at the connection point. As short-circuit protection devices of different technologies have different effects on the short-circuit current in terms of their influence, various specifications are required as interface parameters. If the SCPD reacts to a short circuit without delay, i.e. directly, and is also not current-limiting, then the SCPD prevents the generation of a short-time current and the I_{cw} specification is not required. If the SCPD is also current-limiting, there is no need to specify the rated peak withstand current I_{pl} either.

When developing a new system or an individual solution, the tests are usually performed on entire switchgear and controlgear assemblies. Particularly when developing, expanding or replacing a new generation of protective devices in a system, individual components or functional units such as busbar systems are often tested. For these functional units to be used in an application to be designed based on their interface parameters, these values must be determined and made available. This means that I_{pk} and I_{cw} are specified for a busbar system. These specifications are for the components and do not apply to the switchgear combination. This is due to the fact that the switchgear and controlgear assembly could be implemented again with or without protective devices in the supply circuit.

Once the systemic properties of the combined functional units or switchgear and controlgear assembly have been determined, these interface values must be taken and compared with the short-circuit conditions at the installation site.

For applications with an SCPD, the important criterion is the description of the SCPD itself and the influences on the short-circuit current. The reduction of the load in the event of a short circuit is caused by an SCPD in the circuit of the switchgear and controlgear assembly or an upstream SCPD. Thus, for these applications with I_{cc} , knowledge of the protection device used is important. The description (type and manufacturer) of the equipment also provides information about the maximum permissible on-state currents, short circuit durations and switch-off integrals.

The switchgear and controlgear assembly manufacturer must verify in the short-circuit resistance design verification that the switchgear and controlgear assembly can withstand the short-circuit conditions at the connection point. For this consideration, the short-circuit condition at the switchgear and controlgear assembly's connection point must be known. This value is specified as the uninfluenced short circuit current I_{cp} and must be provided by the planner or user.

The switchgear and controlgear assembly is suitable for the application if the following applies:

$I_{cp} \leq I_{cc}$ or $I_{cp} \leq I_{cw}$
--

In both cases, the verification of short-circuit resistance is fulfilled.

The further the fault is away from the generator, the lower the load to be expected. This is due to the automatic physical influence, such as an increasingly long cable route, with usually increasingly smaller conductor cross-sections.

The aim is always to prevent short-circuits inside the switchgear and controlgear assembly, so that the test focuses on the external faults. This is why the requirements for the circuits and connections inside the switchgear and controlgear assembly are so important in terms of avoiding short circuits. It is easy to see that the lower the short-circuit level in the fault location, the lower the need for any maintenance, cleaning and potential repair work after a short circuit.

Of course, this means that all requirements for the circuits and connections within the switchgear and controlgear assembly are met. In the case of systems that have been implemented in compliance with the rules, it is obvious that if certain values have fallen below a certain short-circuit current level, the influence of the fault will be so small that neither thermal nor dynamic damage inside the switchgear and controlgear assembly are to be expected.

Therefore, in these cases the verification of short-circuit resistance may be omitted. This is regulated by standard IEC / EN IEC 61439 clause 10.11.2.

The verification can be omitted,

(a) if the switchgear and controlgear assembly has a rated short-time withstand current I_{cw} or a conditional short-circuit current I_{cc} of less than or equal to 10 kA.

(b) if the switchgear and controlgear assembly or circuits of the switchgear and controlgear assembly are protected by a current-limiting device which, with a maximum unaffected short-circuit current I_{cp} at the terminals of the switchgear and controlgear assembly, limits the on-state current to 17 kA.

(c) for auxiliary circuits of switchgear and controlgear assemblies intended for connection to transformers, the rated power of which does not exceed 10 kVA at a secondary rated voltage of at least 110 V or 1.6 kVA at a secondary rated voltage of less than 110 V and the short-circuit impedance of which is at least 4 %.

Implementation of cases a), b) and c)

In practice, case (a) means that for many switchgear and controlgear assemblies up to 630 A, the verification of short-circuit resistance can be omitted. Usually these switchgear and controlgear assemblies are directly connected to transformers up to 400 kVA, which have a short-circuit current I_{cp} equal to 10 kA. Case (a) is fulfilled by the requirement $I_{cp} \leq I_{cc}$.

IEC / EN IEC 61439

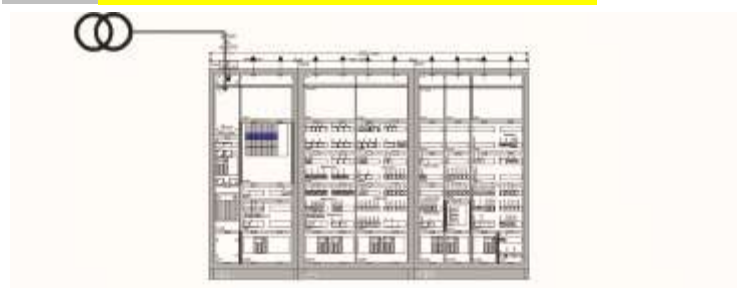
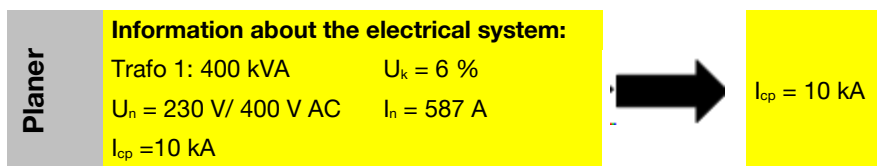

Case (b) means that the forward current is limited to 17 kA by using a short-circuit current-limiting device in the incoming unit (e.g. circuit breaker, NC

fuse, etc.). The output quantity for this consideration is always the I_{cp} , which is available at the supply points.

Thus, for example, an HRC00 (160 A) size NC fuse limits an unaffected short-circuit current of 25 kA to an on-state current of about 17 kA. If this NH fuse is used in the incoming unit of the switchgear and controlgear assembly and the assigned value is $I_{cp} \leq 25$ kA, the verification of short-circuit resistance is not required for this switchgear and controlgear.

In addition, this would be the worst case scenario, since in the case under consideration, the protective device of the outgoing circuit would not react. If the fault occurs in the outgoing circuit as intended, this reduced short-circuit current (cross-section, cable route to the fault location) will cause the protective device provided for this purpose to switch off and the load would be lower.

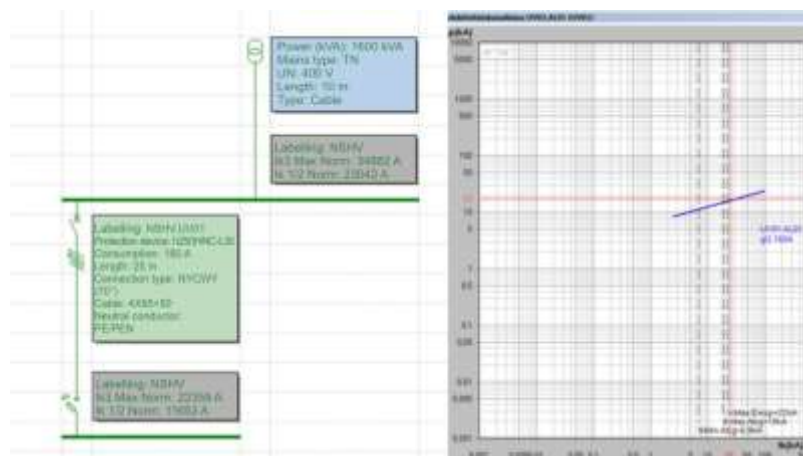

As an example of this, the figure shows the network topology of a power distribution network. At the UV01 connection point, a max. I_{cp} (here = I_{k3max}) of 22.3 kA occurs. By using an HRC00 fuse, the possible short-circuit level is lowered so that, from this point onwards, the verification of the short-circuit resistance by testing can be omitted.

For larger power distributions with higher power, the current-limiting device can also be a component within the switchgear and controlgear assembly behind the incoming unit.

The **rated conditional short-circuit current** I_{cc} is the expected value of the short-circuit current that a switchgear and controlgear assembly can safely withstand during the protective device's entire switch-off time. Therefore, the I_{cc} is always specified if there is a short-circuit protection device (SCPD) in the incoming unit.

If passed, the system test makes it possible to set a value for the I_{cc} . This value depends on the type of enclosure used, the busbar system used and the operating equipment, and is always determined in the interaction of these 3 components. For equipment in the current range above 630 A, the system works with bare connections. Therefore the copper plating from the equipment to the main busbar system is also considered.

After determining the short-circuit resistance of the busbar system used or the connection of the equipment to the busbar system, the I_{cc} can be specified for the switchgear and controlgear assembly.

When selectively designing the equipment or using the equipment as backup protection for each other, usually only the incoming unit is decisive when considering the I_{cc} of the equipment.

The **rated conditional short-circuit current** I_{cc} must be recorded in the system documentation (see cover sheet).

The **rated short-time withstand current** I_{cw} is the effective value of the short-circuit current which the switchgear and controlgear assembly can withstand without damage to components. This value is provided by the switchgear and controlgear assembly manufacturer for a certain period of time (with time specification). This value is specified for switchgear and controlgear assemblies without a short-circuit protection device in the incoming unit. This can be the case in applications where switch disconnectors and busbar systems are used.

The system test, if passed, makes it possible to set a value for the I_{cw} . This value depends on the busbar system used and on the equipment. Since bare connections are used in the system in the current range above 630 A, the copper plating from the equipment to the main busbar system must also be considered.

The **rated short-time withstand current** I_{cw} must be recorded in the system documentation (see cover sheet).

4.12 Verification of short-circuit resistance by applying the design rules

Checklist

The verification by applying design rules is performed by comparing the switchgear and controlgear assembly to be verified with a design that has already been tested, by referring to the checklist according to IEC / EN IEC 61439-2, table 13.

The verification is accomplished if all points can be marked with “YES”.

Point	Element to be assessed	Yes	No
1	Is the rated value of the short-circuit resistance of each circuit of the switchgear and controlgear assembly to be tested less than or equal to that of the reference design?		
2	Are the cross-section dimensions of the busbars and connections of each circuit of the switchgear and controlgear assembly to be tested less than or equal to those of the reference design?		
3	Are the distances of the busbars and the connections of each circuit of the switchgear and controlgear assembly to be tested less than or equal to those of the reference design?		
4	Are the busbar holders of each circuit of the switchgear and controlgear assembly to be tested of the same type, form and material and do they have the same distance or a smaller distance along the length of the busbar as the reference design?		
5	Are the material and material properties of the conductors of each circuit of the switchgear and controlgear assembly to be tested the same as those of the reference design?		
6	Are the short-circuit protection devices of each circuit of the switchgear and controlgear assembly to be tested equivalent, i.e. made by the same manufacturer and from the same series with the same or better current-limiting characteristics (I^2t , I_{pk}) according to the device manufacturer's specifications, and is their arrangement identical to that of the reference design?		
7	Is the length of the unprotected active conductors according to 8.6.4 (IEC / EN IEC 61439-2) of each unprotected circuit of the switchgear and controlgear assembly to be tested less than or equal to that of the reference design?		
8	If the switchgear and controlgear assembly to be tested has a cover, did the reference design also have a cover during the verification by testing?		
9	Does the cover of the switchgear and controlgear assembly to be tested correspond in design and type to the reference design and does it have at least the same dimensions?		
10	Do the compartments of each circuit of the switchgear and controlgear assembly to be tested correspond to the mechanical construction of the reference design and do they have at least the same dimensions?		

4.13 Short-circuit resistance of the protective conductor

General information

In general, the protective conductor connection between the protective conductor of the incoming unit and the protective conductor of outgoing circuits must be capable of carrying 60 % of the corresponding 3-phase short-circuit current.

For this reason, special care must be taken when using constructive parts such as top-hat rails, mounting rails, etc. as protective conductor connections. In the event of high short-circuit levels, additional electrical connections must be used.

Deviating from the exemption of the short-circuit test, various accessories such as top-hat rail fittings and other system-relevant parts were tested with regard to their I_{cw} (1 sec).

However, in normal use, it is assumed that the I_{cw} value is not affected by a short-circuit protection device. This is also used here as a comparative value.

Report	Part reference	Project	Contact	Test according to *	I_{cw}	Test site
1048PML	Top-hat rail, long, untreated	TSCA short-circuit	Screw	SC test 60439 - 1	7.4 kA	I ² PS Bonn
1058PML	Top-hat rail, short Untreated	TSCA short-circuit	Screw	SC test 60439 - 1	7.2 kA	I ² PS Bonn
1068PML	Top-hat rail, short Treated	TSCA short-circuit	Screw	SC test 60439 - 1	8.2 kA	I ² PS Bonn
1078PML	Top-hat rail, long Treated	TSCA short-circuit	Screw	SC test 60439 - 1	8.7 kA	I ² PS Bonn
0199PML	NB116, KX50H	TSCA short-circuit	Screw	SC test 60439 - 1	10 kA	I ² PS Bonn
0209PML	KX50H	TSCA short-circuit	Screw	SC test 60439 - 1	1.6 kA 200 ms	I ² PS Bonn

* Where tests on the assembly have been conducted in accordance with the IEC 60439 series (withdrawn) or previous editions of the IEC / EN IEC 61439 series, and the test results fulfil the requirements of the current edition of the relevant part of IEC / EN IEC 61439 series, the verification of these requirements need not be repeated.



Terminal

4.14 Electromagnetic compatibility (EMC)

General information

When developing the system, the aim was to minimise the amount of tests required by the switchgear and controlgear assembly manufacturer, and to reduce testing to a minimum. Especially with regard to EMC, the standard IEC / EN IEC 61439-1 explains how to reduce or even avoid testing.

The fact that switchgear and controlgear assemblies are, in most cases, individually manufactured or assembled and contain a more or less random combination of equipment is described in clause J.9.4.2 of the standard in the “Test requirements” clause.

EMC immunity and EMC emission tests do not need to be performed on finished switchgear assemblies if the following conditions are met:

- The built-in equipment is designed for the specified environment in accordance with the applicable EMC product standards or basic EMC technical standards.
- The internal installation and wiring is carried out according to the specifications of the manufacturers of the equipment (arrangement regarding mutual interference, shielded cables, earthing, etc.).

In all other cases, the EMC requirements must be verified by tests in accordance with clause J.10.12 of IEC / EN IEC 61439-1.

For the majority of applications of switchgear and controlgear assemblies falling within the scope of this standard, two ambient conditions are considered and described as follows:

- Environment A
- Environment B

Environment A refers to a power supply network that is connected to its own high or medium voltage distribution transformer which is intended to supply power to a factory or similar facility and is also intended for use in or near industrial environments as described below. This standard also applies to battery-powered devices (equipment, installations) intended for use in industrial environments.

The environments covered are industrial environments, both inside and outside buildings.

Industrial environments are also characterised by the presence of one or more of the following conditions:

- Industrial, scientific and medical (ISM) equipment as defined in CISPR 11 is present.
- Large inductive or capacitive loads are often switched.
- Currents and associated magnetic fields are large.

Comment: Environment A is covered by the basic EMC standards IEC 61000-6-2 and IEC 61000-6-4.

Environment B refers to public low-voltage power supply networks or equipment connected to a special DC power supply intended to connect the equipment to the public low-voltage power supply network. This standard also applies to battery-powered devices (equipment, installations) and to devices (equipment, installations) which are supplied by a non-public, but also non-industrial low-voltage power supply network, insofar as these are intended for use in the operating locations described below.

The environments covered are residential, commercial, industrial and small business environments, both inside and outside buildings. The following list, although not exhaustive, gives an indication of recorded places of operation:

- Residential property, e.g. houses, flats
- Retail sector, e.g. stores, supermarkets
- Business premises, e.g. offices, banks
- Public places of entertainment, e.g. cinemas, public bars, dance clubs
- Outdoor areas, e.g. petrol stations, car parks, amusement venues and sports facilities
- Small businesses, e.g. workshops, laboratories, service centres.

Sites characterised by the fact that they are directly connected to the public low-voltage electricity supply are considered to belong to residential areas or to business and commercial areas or small businesses.

Comment: Environment B is covered by the basic EMC standards IEC 61000-6-1 and IEC 61000-6-3.

4.15 Mechanical function

System checks and testing

It must be ensured that all covers or partitions, including locking devices and hinges for doors, are mechanically strong enough to withstand the loads that occur during operation and under short-circuit conditions. This is ensured by our system checks.

The mechanical function of removable parts, including any encoders, must be verified by testing. This requirement is not relevant for the quadro evo application. In the unimes H area, this is also ensured by the system check.

In the case of parts of the quadro evo system switchgear and controlgear assemblies which have been installed in accordance with the instruction leaflet / construction requirements and available documentation, no verification of mechanical function needs to be provided.

If the mechanical function has been changed by the way in which it has been installed, it is the responsibility of the switchgear and controlgear assembly manufacturer to check this according to the standard.

For such parts which require verification by testing, the flawless mechanical function must be verified after installation in the switchgear and controlgear assembly. The number of operating cycles is 200.

At the same time, the function of mechanical locking devices that are coupled with these movements must be tested. The test is passed if the operation of the device, the locking mechanisms, the specified degree of protection, etc. have not been impaired and if the degree of effort required for operation before and after the test remains virtually unchanged.

4.16 Maintenance and assembly

Maintenance conditions (in compliance with VDE 0100 part 610)

The instruction leaflet enclosed with the modules must be observed in order to install the system correctly and in accordance with the installation regulations.

In accordance with VDE 0100 part 610, the following maintenance conditions for switchgear and controlgear assemblies must be observed in the quadro evo system:

- Visual inspection of barriers and enclosures to check for damage impairing the protection type
- Visual inspection of contact points
- Checking of contact points in the main circuits, if necessary retightening them with the torques according to the 'Busbar terminals' table (in the annex)
- Functional inspection of protective switchgear, e.g. earth-leakage circuit breakers
- Functional inspection of the display features of analogue measuring devices (if present)
- Checking of the adjustment values of the equipment and devices (e.g. circuit breakers) according to the switching documents
- Visual inspection for damage of individual conductors
- Visual inspection of the individual equipment for changes in form or colour which could have been caused by thermal influences
- Elimination of identified defects (e.g. by replacing the faulty equipment)

Pictograms in instruction leaflet

The following pictograms are used in the instruction leaflet and must be observed.

Pictogram



Meaning

Installation by trained specialist personnel



Construction of the system indoors only

5 quadro evo technical information and characteristics

Technical information and characteristics of the switchgear in quadro evo.

Chapter index

Design verification	287
Verification of temperature rise in low-voltage switchgear and controlgear assemblies	293
Verification by tests of the original manufacturer	328
Routine verification	376
Installing	382
Connections	382
Commissioning	383
Maintenance	384

5.1 Design verification

PSC testing

A Power Switchgear and Controlgear Assembly (PSC) designed and produced to a precise specification of the main characteristics of the switchboard in its environment must undergo verification or test phases.

Every PSC must be systematically verified to enhance safety and performance based on specification requirements such as temperature rises, diversity factors, protection against external influences, mechanical endurance, short - circuit resistance, etc.

The PSC must also be supplied with documentation so that upgrades can be tracked.

IEC / EN IEC 61439-1 defines the general rules and details the verification requirements to guarantee the conformity of the assembly produced.

A switchboard, while distributing power and controlling a process, also protects people and property. Therefore the level of quality and performance of the equipment must be able to handle the operator consequences of a fault, malfunction or deterioration.

Key points to remember:

- Verify each assembly systematically
- Provide documentary traceability
- Clarify specification requirements

Clarify the responsibilities and obligations of each party involved in the project. During the design phase the manufacturer or original manufacturer has a duty to comply with the requirements of IEC 61439 Part 2. The manufacturer therefore develops an assembly reference system, which is verified by:

- tests
- calculations or
- design rules

Design and performance checks must be conducted and validated throughout the switchboard production process.

The assembly manufacturer translates the customer's needs into a suitable technical solution.

The manufacturer is responsible for selecting and assembling the components, and for carrying out routine verifications on each PSC manufactured. The manufacturer draws up the EC declaration of conformity report, referring to the test certificates, and ensures documentary traceability.

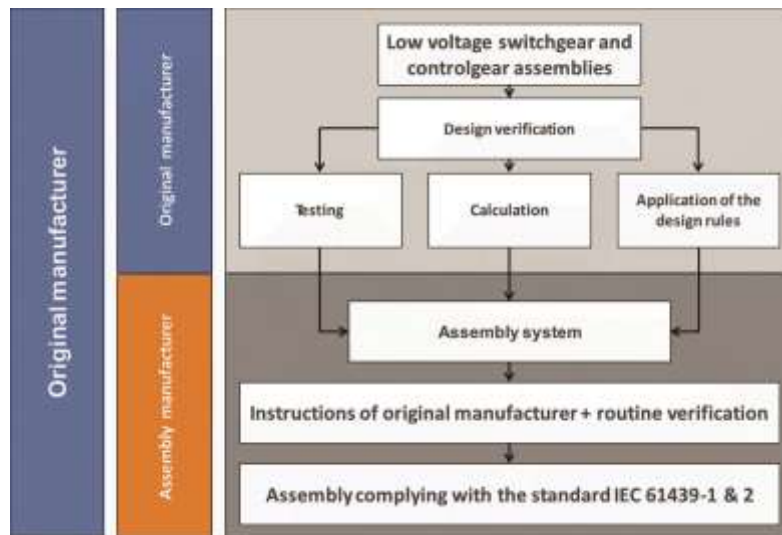

- Assembly or PSC produced: Complete system of electrical and mechanical components such as enclosures, busbars and functional units.
- Original manufacturer: Responsible for the original design and associated verification of an assembly compliant with IEC / EN IEC 61439-1 / -2.
- Assembly manufacturer: The organisation that takes responsibility for final assembly. This may be different to the original manufacturer.

Reminder: If the assembly manufacturer modifies or fails to comply with the original manufacturer's instructions, he is then considered the original manufacturer and must carry out all 13 verifications.

This constraint also applies when the assembly manufacturer substitutes equipment or components by third party equipment.

Design verification

There are 13 design verifications to be carried out by the original manufacturer according to IEC / EN IEC 61439-1 Annex D, Table D1 as shown below.

The verifications are intended to verify that the assembly complies with the requirements of the standard.

No.	Characteristic to be verified	Clauses or subclauses	Verification options available		
			Testing	Comparison with a reference design	Assessment
1	Strength of material and parts:	10.2	-	-	-
	Resistance to corrosion	10.2.2	Yes	No	No
	Properties of insulating materials:	10.2.3	-	-	-
	Thermal stability	10.2.3.1	Yes	No	No
	Resistance to abnormal heat and fire due to internal electric effects	10.2.3.2	Yes	No	Yes
	Resistance to ultra-violet (UV) radiation	10.2.4	Yes	No	Yes
	Lifting	10.2.5	Yes	No	No
	Mechanical impact	10.2.6	Yes	No	No
	Marking	10.2.7	Yes	No	No
2	Degree of protection of enclosures	10.3	Yes	No	Yes
3	Clearances	10.4	Yes	No	No
4	Creepage distances	10.4	Yes	No	No
5	Protection against electric shock and integrity of protective circuits:	10.5	-	-	-
	Effective continuity between the exposed conductive parts of the assembly and the protective circuit	10.5.2	Yes	No	No
	Short-circuit withstand strength of the protective circuit	10.5.3	Yes	Yes	No
6	Incorporation of switching devices and components	10.6	No	No	Yes
7	Internal electric circuits and connections	10.7	No	No	Yes
8	Terminals for external conductors	10.8	No	No	Yes
9	Dielectric properties:	10.9	-	-	-
	Power-frequency withstand voltage	10.9.2	Yes	No	No
	Impulse withstand voltage	10.9.3	Yes	No	Yes
10	Temperature-rise limits	10.10	Yes	Yes	Yes

No.	Characteristic to be verified	Clauses or subclauses	Verification options available		
			Testing	Comparison with a reference design	Assessment
11	Short-circuit withstand strength	10.11	Yes	Yes	No
12	Electromagnetic compatibility (EMC)	10.12	Yes	No	Yes
13	Mechanical operation	10.13	Yes	No	No

Design verification checklist

1: Strength of material and parts

The assembly must therefore be verified with respect to:

- corrosion resistance
- thermal stability and resistance against exceptional heat
- resistance against ultraviolet (UV) radiation
- resistance against mechanical impact
- durability of marking
- reaction to lifting and transport operations

2: Degree of protection of enclosures

When using an empty enclosure compliant with IEC 62208, no further test is required unless an external modification impairs the degree of protection.

IP tests must be carried out with all panels and doors in place and closed as per normal service and with the equipment switched off unless otherwise indicated.

If an assembly has multiple IPs, the assembly manufacturer must declare the IP of each of the parts.

3: Clearances

The rated impulse withstand voltage (U_{imp}) of the board depends mainly on the operating voltage and transient overvoltages on the upstream network, such as lightning or HV connections.

This verification validates the assembly's suitability to withstand overvoltage.

Clearances are given in the table below according to IEC / EN IEC 61439-1 clause 8.3.2.

Rated impulse withstand voltage U_{imp} (kV)	Minimum clearance (mm) up to 2000 m
≤ 2.5	1.5
4.0	3.0
6.0	5.5
8.0	8.0
12.0	14.0

Withstand voltage tests must be carried out in all cases unless clearances are more than 1.5 times those given in the table.

4: Creepage distances

The original manufacturer must choose one or more rated insulation voltages (U_i) for PSC circuits. These voltages are used to determine creepage distances. The rated insulation voltage for any given circuit must not be less than the rated operating voltage (U_e).

5: Protection against electric shock

This check verifies that all the earth interconnections and the protective circuit are correctly implemented and effective.

Protection against the consequences of internal faults in the assembly and of external faults within electrical circuits supplied by the PSC that have an impact inside the PSC.

6: Incorporation of switching devices and components

Verification that the switchgear installation is in accordance with the manufacturer's instructions (compliance with safety zones, connection rules, etc.) and EMC if applicable.

7: Internal electrical circuits and connections

Verification of internal circuit dimensions (busbars and connections), thermal dimensioning for heating, resistance to short-circuit currents. Conductor markings.

8: Terminals for external conductors

Verification of the capacity of the connection points (cross-section and number of conductors) and whether or not the use of copper or aluminium cables is compatible.

9: Dielectric properties

All electrical devices connected to the PSC are subjected to the test voltage.

10: Temperature rise limits

Verification of the assembly's thermal stability and compliance with the temperature rise limits on devices, connections and accessible parts, by means of laboratory tests either by applying the appropriate design rules or by using algorithms to calculate the temperature rise.

11: Short-circuit withstand strength

Verification of declared resistance to rated currents for short circuits.

As specified by the standard, verification of short-circuit withstand strength is not necessary for assemblies with a rated short-circuit current of 10 kA rms or less, or when the peak let - through current is less than 17 kA.

Likewise for auxiliary circuits connected to transformers with a power below 10 kVA.

12: Electromagnetic compatibility (EMC)

If the switchgear or built-in components comply with EMC requirements and the installation and wiring are carried out in accordance with the manufacturer's instructions, no EMC immunity or emissions testing is required.

13: Mechanical function

All enclosures or partitions, including closures and door hinges, must have sufficient mechanical strength to withstand the stresses to which they may be subjected in normal use and in short-circuit conditions.

The mechanical function of removable parts, including locking devices, must be verified by testing 200 activation cycles.

5.2 Verification of temperature rise in low-voltage switchgear and controlgear assemblies

General information

Assessing temperature rise limits is an important criterion for low voltage switchgear and controlgear assemblies. Incorrect assessments of temperature rise limits can cause production and machine failures and the loss of working hours (time taken to repair the system).

Therefore, a corresponding standard to determine temperature rise limits is of great interest, both for the operator and for the switchgear and controlgear assembly manufacturer.

5.2.1 Type of enclosure, enclosure materials

Influence of enclosure type and enclosure materials

In theory, we tend to assume that an enclosure made of an insulating material or an enclosure with a high protection class has a worse temperature behaviour than a steel plate enclosure or one that is in a low protection class.

In practice, however, the steady-state is used when considering temperature rise in switchgear and controlgear assemblies.

In doing so, the temperature rise test is continued until the temperature rise reaches an approximately constant value. A value is considered to be constant if the temperature does not change by more than 1 Kelvin per hour. These conditions result in only negligible differences between the enclosures mentioned above.

As a result, differences such as the design of the enclosure material, the wall thickness of an enclosure or the coatings of an enclosure can be ignored.

5.2.2 Conductors and busbars

Considering of conductors and busbars

Conductors must be included when considering power loss as thermal power loss increases quadratically with current intensity. The same applies to busbars.

As a rule, control cables do not need to be taken into account when considering current heat losses. The power losses of the control cables are often already included in the specifications for the power losses of the control units.

5.2.3 Notes on reducing power loss in enclosures

Power loss in enclosures

Indirect measures are measures that can be taken during the planning stage.

Direct measures are measures that have a direct effect on heat reduction in the switching enclosure.

Indirect measures

Better heating conditions can be achieved by a well-thought-out arrangement of the equipment.

For example, devices with a large power loss and which therefore generate a large amount of heat are positioned in the lower part of the system so that the heat emitted can escape upwards.

The possible mutual heating of the individual devices must also be considered. This means that heat-sensitive devices should be positioned in the lower area of the system.

The environmental conditions at the installation site must also be taken into account when planning.

Direct measures

Dissipation of heat loss by the exchange of air. In this case, additional ventilation openings can force the exchange of air inside the switching enclosure.

Dissipation of heat loss by fans. Cooler ambient air is sucked in by fans and the heated interior air is removed again.

Dissipation of heat loss by heat exchange. Here the heat exchange is forced by cooling devices.

5.2.3.1 Field of application

For distribution boards closed on all sides with dimensions according to DIN 43870, and as special requirements for low-voltage switchgear and controlgear assemblies which are accessible to ordinary persons.

5.2.3.2 Conclusion

General information

If the determined power losses (sum of devices, switching enclosure) are compared in an energy balance, conclusions can be drawn about the actual and maximum temperature conditions.

An enclosure with defined dimensions and a defined degree of protection can dissipate a certain amount of heat by the free flow of air. The criterion for the limit value of the power loss that can be dissipated is the temperature inside the enclosure at which the function of the installed electrical equipment is not impaired. In addition, the temperatures of the touchable outer sheath must fall within the conditions specified in IEC / EN IEC 61439-1 table 6 'Temperature rise limits'.

The heat dissipation capacity of an enclosure depends mainly on the protection class and is influenced by:

- the size of the enclosure,
- the proportions (height / width / depth),
- the presence of air ventilation openings,
- the temperature difference (ΔT) between the inside of the enclosure and the ambient air,
- the enclosure's installation type,
- and the distribution of heat sources inside the device.

Unless otherwise agreed, the ambient temperature of the switchgear and controlgear assembly is the air temperature that has been specified as an average value of 24 hours for indoor installation: 35 °C.

If the ambient temperature outside the system differs from the average value of 35 °C, this value should be used as the ambient temperature. The agreement is the responsibility of the switchgear and controlgear assembly manufacturer and the user.

For switchgear assemblies according to IEC / EN IEC 61439-1 / -2 and IEC / EN IEC 61439-1 / IEC / DIN EN 61439-3, it must be verified that the temperature rise limits for the different parts of the switchgear and controlgear assembly or the switchgear and controlgear assembly system specified in IEC / EN IEC 61439-1 are not exceeded.

NOTICE

Evidence of verification must be provided by one or more of the following methods:

- Testing with electricity;
- Derivation of design values from similar variants (from a tested type);
- or calculation.

5.2.4 Verification of temperature rise with the quadro evo system

General information

Different paths were explored for the quadro evo system, depending on the application. On the one hand, complete switchgear and controlgear assemblies were tested. This can also be done for individual solutions in coordination with the Product Marketing department of Hager Electro GmbH & Co.KG and the laboratory. For better dissipation, special applications in which the items of equipment are directly mounted next to each other, were tested as functional units, and the rated diversity factor (RDF) was determined. Information about these resources and notes on resources requiring special treatment can be found in 'Bundling of equipment' later in this main section.

In principle, the calculation methods based on measured values were chosen as a solution to verify the heating.

Evidence of verification can be produced in three ways:

1st method

"Adjusting the power loss (P_v) of built-in equipment with the permissible power loss ($P_{perm.}$) of the enclosures". This method addresses enclosures which Hager has equipped with equipment and / or equivalent resistors, and in which it has measured the $P_{perm.}$ per temperature difference. In this way, the built-in power loss as a function of the usable temperature difference has been determined for all enclosures in the quadro evo series, and presented in a table.

2nd method

"Determining the heating inside the switchgear and controlgear assembly" based on the method defined in IEC 60890. Here, the calculated power loss is used as a basis to determine the temperature curve inside the enclosure. To simplify the calculation process for the switchgear and controlgear assembly manufacturer, the heating values in 50 % and 100 % of the enclosure's height were determined as a function of the built-in power loss and also displayed in a table. Thus, by entering the specified values in the graph, the temperature curve in the switchgear and controlgear assembly can be easily represented.

3rd method

"Verification by testing". In this case, for the switchgear and controlgear assembly system to be verified, heating, which comprises a number of variants, is determined precisely by tests based on the most unfavourable arrangement(s). The test results can be used to derive or specify the design values of similar, less critical variants without the need for further tests.

Test results for individual functional units, the main busbars, the distribution bars and the switchgear are provided.

Factors such as arrangement, grouping, current rating, connection cross-sections, etc. must be taken into account for the compliant design of the switchgear

5.2.4.1 Bundling of equipment

General information

In principle, the technical data from the Hager catalogues should be used.

To facilitate work in the system, special features, which are important with regard to thermal properties in the switchgear and controlgear assembly, are highlighted below.

In the case of functional units with similar outgoing circuits, **two scenarios** should be taken into account when planning.

- **Scenario A)** The outgoing circuits are not or are only negligibly impeded by the surrounding equipment during heat emission.
- **Scenario B)** The outgoing circuits are mounted directly next to each other / above one another. E.g. fuse switch disconnectors in the in-line system. Thermal influence is very substantial here. The bundles were measured and the values from the following table should be used.

Miniature circuit breakers



Note on the loading capacity of miniature circuit breakers

The ambient temperature influences the thermal tripping behaviour of miniature circuit breakers.

The rated currents printed on the devices are valid at a temperature of 30 °C. Therefore, currents entered in this column are identical to the rated currents of the miniature circuit breakers because, at this temperature, the tripping behaviour is set in the factory.

The table also shows the corrected values of the rated currents in relation to the ambient temperatures.

I _n [A]	30 °C	35 °C	40 °C	45 °C	50 °C	55 °C	60 °C
0.5	0.5	0.47	0.45	0.4	0.38	-	-
1	1	0.95	0.9	0.8	0.7	0.6	0.5
2	2	1.9	1.7	1.6	1.5	1.4	1.3
3	3	2.8	2.5	2.4	2.3	2.1	1.9
4	4	3.7	3.5	3.3	3	2.8	2.5
6	6	5.6	5.3	5	4.6	4.2	3.8
10	10	9.4	8.8	8	7.5	7	6.4
16	16	15	14	13	12	11	10

I_n [A]	30 °C	35 °C	40 °C	45 °C	50 °C	55 °C	60 °C
20	20	18.5	17.5	16.5	15	14	13
25	25	23.5	22	20.5	19	17.5	16
32	32	30	28	26	24	22	20
40	40	37.5	35	33	30	28	25
50	50	47	44	41	38	35	32
63	63	59	55	51	48	44	40

NOTE

Depending on the ambient temperatures, the load capacity of the miniature circuit breakers is influenced by the bundling. The rated currents influenced by the ambient temperature must also be reduced by observing the following table.

Correction factor (K) in the case of mutual thermal influence of miniature circuit breakers mounted side by side at rated load:

Number of miniature circuit breakers (*)	K
1	1.0
2...3	0.95
4...5	0.9
≥ 6	0.85

(*) applies to 1-, 2-, 3-, 4-, 1+N, 3+N - pole devices

The tripping behaviour of miniature circuit breakers is also frequency-dependent. It is influenced when connected to mains systems with a frequency other than 50 Hz. This and other basic data can be found in the equipment's technical data.

Contactors and installation relays

In order to reduce the mutual interference of contactors and installation relays, a spacer should be used for half a space unit in an **LZ060** modular device series when bundling such devices.



Measuring equipment



Measuring accuracy is influenced by the ambient temperature. Observe the technical data of the measuring equipment.

Moulded-case circuit breaker, size x160



Number of MCCBs	Cable cross-section of inputs and outgoing connections [mm ²]	Rated current [A]	Max. current [A]	RDF
1	70	160	140	0.88
2-5	70	160	128	0.80

When using connection extensions:

Number of MCCBs	Cable cross-section of inputs and outgoing connections [mm ²]	Rated current [A]	Max. current [A]	RDF
1	70	160	136	0.85
2-5	70	160	123	0.77

Moulded-case circuit breaker, size x250

Number of MCCBs	Cable cross-section of inputs and outgoing connections [mm ²]	Rated current [A]	Max. current [A]	RDF
1	120	250	200	0.80
2-5	120	250	163	0.65

Moulded-case circuit breaker, size h400 - h1600

Size	Cable cross-section of outgoing connections [mm ²]	Cable outlet	RDF	Max. current [A]
h400	240	top / bottom	0.8	320
h630	2 x 185	top / bottom	0.8	504
h800	1 x 50 x 10	top / bottom	0.8	640
h1000	2 x 30 x 10	top / bottom	0.8	800
h1600	2 x 50 x 10	top / bottom	0.8	1280

5.2.4.2 Method 1: Adjusting the power loss (P_v) of built-in equipment with the permissible power loss (P_{perm}) of the enclosures

Method 1

For the verification of a switchgear and controlgear assembly with a single compartment and a rated current not exceeding 630 A and for rated frequencies up to and including 60 Hz, the verification by calculation is performed as follows:

- Select an enclosure according to the space requirement of the devices to be installed.
- The power loss is approximately evenly distributed within the enclosure.
- The rated currents of the circuits of the switchgear and controlgear assembly must not exceed 80 % of the conventional thermal currents in free air I_{th} or the rated currents I_n of the electrical equipment in the circuit.

NOTE:

The circuit protection devices must be selected so that the outgoing circuits are adequately protected, e.g. devices for thermal motor protection at the calculated temperature in the switchgear assembly.

- Determining the effective power loss:
 - The power losses of all selected devices, conductors and busbars are available (see section ‘Power loss of equipment’).
 - The expected power losses of the equipment are determined according to their rated current using the following formula.

$$P_V = P_N \left[\frac{I_B}{I_N} \right]^2$$

- If no load currents I_B are defined by the system operator and the switchgear and controlgear assembly manufacturer, the assumed load factors according to table 101 of IEC / EN IEC 61439-2 (energy switchgear combination) or IEC / EN IEC 61439-3 (distribution boards) must be applied. The product of the multiplication of I_{nc} and the assumed load factor is included in the power loss calculation.
- The power loss of the conductors must also be taken into account. This information can be found in the following tables. The values provided there are based on the cross-section assignments from VDE 0100 Part 430/6.8.1 (table 1 ‘Assignment of line protection fuses...’), matched to the rated currents of the devices.

An average cable length of 0.7 m was used as a basis. The calculated power losses of the P_v lines have already been added to the P_v power losses of the devices in the tables in the column P_v + P_{v line}.

NOTE:

It must be taken into account that the total load current is limited to the rated current of the switchgear and controlgear assembly I_{nA}.

Example:

A switchgear combination with only one compartment and a rated current of 100 A (limited by the distribution bars) is equipped with 20 outgoing circuits. The assumed load current of each circuit is 8 A.

The total effective power loss must be calculated for 12 outgoing circuits, each loaded with 8 A.

NOTE:

Devices exist with power losses essentially proportional to I² and others with essentially constant power dissipation.

- The power losses of the individual equipment must be added up and the total power loss is determined (HagerCAD software, if applicable).
- The mechanical parts and the installed equipment must be arranged in such a way that the air circulation is not significantly impaired.

NOTE:

This is especially important for mounting plates that can be freely equipped.

This design requirement has been taken into account when using the modules and kits. In order to facilitate planning, items of equipment that are lined up in a row together and therefore strongly influence each other were additionally tested with regard to the rated load diversity RDF (IEC / EN IEC 61439-1).

- Conductors carrying currents in excess of 200 A and adjacent structural components are arranged in a way which minimizes eddy currents and hysteresis losses

NOTE:

Busbar arrangements and equipment mountings (e.g. circuit breakers) have been specially designed to meet this requirement. When wiring, care must be taken to maintain this design feature.

- All conductors must be dimensioned to 125 % of the minimum cross-section corresponding to the rated current of the functional unit according to IEC 60364-5-52.

NOTE:

When dimensioning, it must be ensured that not the I_{th} or I_n but the rated current of the circuit is used.

Examples of the application of this standard to the conditions in a switchgear and controlgear assembly are provided in the tables in the sections 'Internal electrical circuits and connections' and 'Connections for conductors inserted from the outside'. If a conductor with a different cross-section is required from a test, this is added to the relevant section.

- Determining the permissible temperature rise of the air in the switchgear and controlgear assembly. Here the devices' maximum operating temperature must be observed, e.g. $\Delta T = 20 \text{ }^\circ\text{C}$.
- Selection of an enclosure in which the maximum radiation of heat of the enclosure is greater than or equal to the power loss of the installed equipment.

NOTE:

The values were measured in accordance with IEC / EN IEC 61439-1, -2 clause 10.10.4.2.2.

NOTE:

The quadro evo system works without internal horizontal partitions as standard. If required by the application, the permissible power loss must be reduced by the factor a for up to a maximum number of three partitions. The value a can be taken from the Conversion factor a table. $P_{perm.} = a P_{perm.}$

Conversion factor a table

Conversion factor a - power loss

Number of internal horizontal dividers	Conversion factor a
0	1.00
1	0.94
2	0.84
3	0.72

Table 101 for power switchgear combinations

Assumed load factor f in accordance with IEC / EN IEC 61439-2 table 101

Load type	Assumed load factor
Power distribution - 2 and 3 electrical circuits	0.9
Power distribution - 4 and 5 electrical circuits	0.8
Power distribution - 6 to 9 electrical circuits	0.7
Power distribution - 10 and more electrical circuits	0.6
Actuator	0.2
Motors ≤ 100 kW	0.8
Motors >100 kW	1

Procedure to verify compliance with the limit temperature

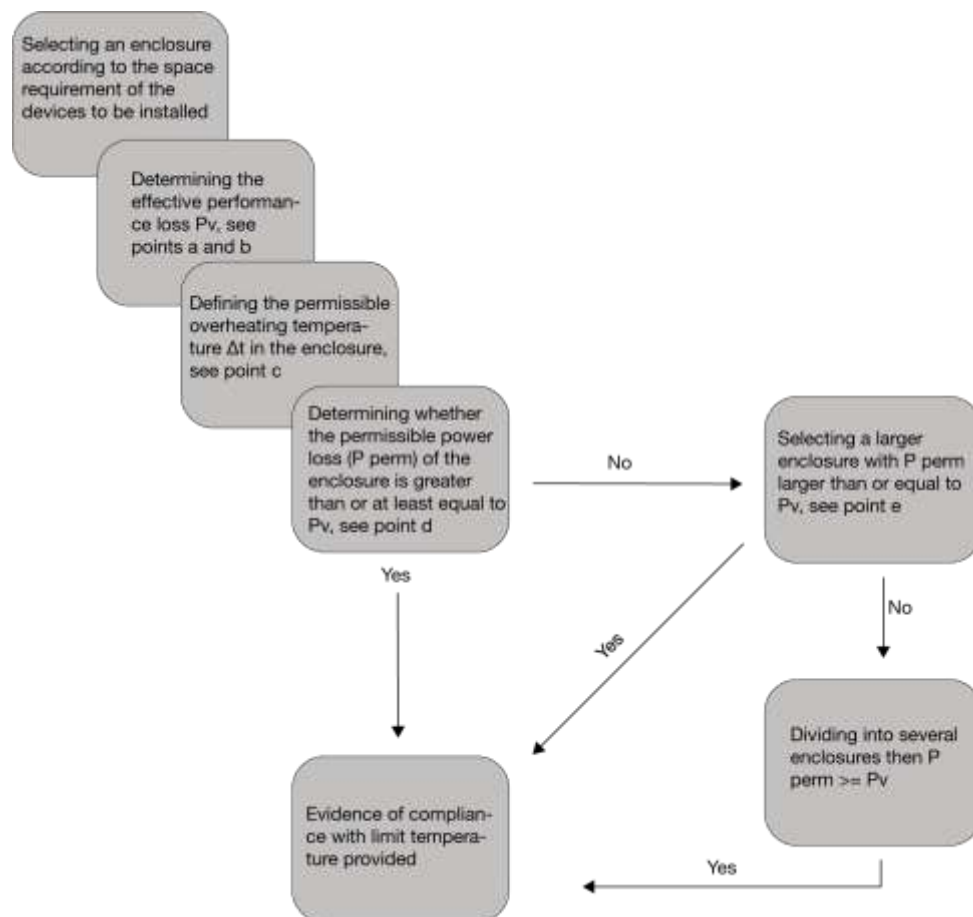

P_{perm} = maximum radiation of heat of the enclosure

P_v = power losses of the built-in devices and conductors

Verification of compliance with the limit temperature

If the criterion from the figure 'Procedure to verify compliance with the limit temperature' is not fulfilled, other measures must be taken such as:

- Dividing into several enclosures
- Dividing into several fields
- Providing air-conditioning in the switchgear and controlgear assembly
- Providing a design with a lower power loss (e.g. larger Cu cross-sections, a different arrangement of the components, etc.)

5.2.4.3 Method 2: Determining heating inside the switchgear and controlgear assembly

Method 2

Method 2 is used for verifying a switchgear and controlgear assembly above 630 A and below 1600 A and on the other hand switchgear and controlgear assemblies consisting of several compartments. As with method 1, the limit of 60 Hz must also be observed here. The calculation is carried out in accordance with IEC 60890.

To simplify the calculation process for the switchgear and controlgear assembly manufacturer, the heating values in 50 % and 100 % of the enclosure's height were determined as a function of the built-in power loss. These are displayed in a table. Thus, by entering the specified values in the graph, the temperature curve in the switchgear and controlgear assembly can be easily represented.

When following the method, the following conditions must be fulfilled:

- Select an enclosure according to the space requirement of the devices to be installed.
- The power loss is approximately evenly distributed within the enclosure.
- The rated currents of the circuits of the switchgear and controlgear assembly must not exceed 80 % of the conventional thermal currents in free air I_{th} or the rated currents I_n of the electrical equipment in the circuit.

NOTE:

the circuit protection devices must be selected so that the outgoing circuits are adequately protected, e.g. devices for thermal motor protection at the calculated temperature in the switchgear assembly.

- Determining the effective power loss:
 - The power loss of all selected devices, conductors and busbars are available (see clause 'Power loss of equipment').
 - The expected power losses of the equipment are determined according to their rated current using the following formula.
- If no load currents I_B are defined by the system operator and the switchgear and controlgear assembly manufacturer, the values for assumed load according to table 101 of IEC / EN IEC 61439-2 (energy switchgear combination) or IEC / EN IEC 61439-2 (distribution boards) must be applied. The result of the multiplication of I_{nc} and the assumed load factor are included in the power loss calculation.
- The power loss of the conductors must also be taken into account. This information can be found in the following tables. The values provided there are based on the cross-section assignments from VDE 0100 part 430/6.8.1 (table 1 'Assignment of line protection fuses...'), matched to the rated currents of the devices.

$$P_V = P_N \left[\frac{I_B}{I_N} \right]^2$$

An average cable length of 0.7 m was used as a basis. The calculated power losses of the PV lines have already been added to the PV power losses of the devices in the tables in the column PV + PV line.

NOTE:

It must be taken into account that the total load current is limited to the rated current of the switchgear and controlgear assembly I_{nA} .

Example:

A switchgear combination with only one compartment and a rated current of 100 A (limited by the distribution bars) is equipped with 20 outgoing circuits. The assumed load current of each circuit is 8 A. The total effective power loss must be calculated for 12 outgoing circuits, each loaded with 8 A.

NOTE:

Devices exist with power losses essentially proportional to I^2 and others with essentially constant power dissipation.

- The power losses of the individual equipment must be added up and the total power loss is determined (HagerCAD software, if applicable).
- The mechanical parts and the installed equipment must be arranged in such a way that the air circulation is not significantly impaired.

NOTE:

This is especially important for mounting plates that can be freely equipped. This design requirement has been taken into account when using the modules and kits. In order to facilitate planning, items of equipment that are lined up in a row together and therefore strongly influence each other were additionally tested with regard to the rated load diversity RDF (IEC / EN IEC 61439-1).

- Conductors carrying currents in excess of 200 A and adjacent structural components are arranged in a way which minimizes eddy currents and hysteresis losses

NOTE:

Busbar arrangements and equipment mountings (e.g. circuit breakers) have been specially designed to meet this requirement. When wiring, care must be taken to maintain this design feature.

- All conductors must be dimensioned to 125 % of the minimum cross-section corresponding to the rated current of the functional unit according to IEC 60364-5-52.

NOTE:

When dimensioning, it must be ensured that not the I_m or I_n but the rated current of the circuit is used.

Examples of the application of this standard to the conditions in a switchgear and controlgear assembly are provided in the tables in the sections 'Internal electrical circuits and connections' and 'Connections for conductors inserted from the outside'. If a conductor with a different cross-section is required from a test, this is added to the relevant section.

NOTE:

The values were measured in compliance with IEC / EN IEC 61439-1 / -2 clause 10.10.4.2.2.

It must be ensured that the permissible temperature rise of the air in the switchgear and controlgear assembly does not exceed the maximum operating temperature of the devices.

Using the values in the table significantly shortens the verification procedure.

To enable evidence to be provided according to this procedure for stand-alone distributors other than those listed, the procedure is shown in detail at the end of this section. In principle, however, the data provided eliminates the calculation procedure or shortens it to a comparison of the graph with the maximum ambient temperatures of the equipment.

This method also makes it possible to verify the heating for enclosures with natural ventilation. In doing so, it must be ensured that the cross-section of the air outlet openings is at least 1.1 times that of the air inlet openings.

NOTE:

The method is limited to ensuring that there are no more than three horizontal divisions in the switchgear and controlgear assembly or in a field of a switchgear and controlgear assembly. If several horizontal compartments are to be installed, verification by method 3: Testing is necessary.

NOTE:

The standard also provides for the case that an enclosure consists of several compartments and is cooled by natural ventilation. In this case, the cross-section of the ventilation openings in each horizontal subdivision must be at least 50 % of the horizontal cross-section of the compartment.

Table 101 for distribution boards for ordinary users

Assumed load factor f in accordance with IEC / EN IEC 61439-3 table 101

Number of outgoing circuits	Assumed load factor
2 and 3	0.8
4 and 5	0.7
6 to 9 inclusive	0.6
10 and more	0.5

Table 101 for power switchgear combinations

Assumed load factor f in accordance with IEC / EN IEC 61439-2 table 101

Load type	Assumed load factor
Power distribution - 2 and 3 electrical circuits	0.9
Power distribution - 4 and 5 electrical circuits	0.8
Power distribution - 6 to 9 electrical circuits	0.7
Power distribution - 10 and more electrical circuits	0.6
Actuator	0.2
Motors ≤ 100 kW	0.8
Motors >100 kW	1

The calculation is carried out in accordance with IEC 60890

NOTE:

In the case of quadro evo modular stand-alone distributors, the results graphic can be generated using the table values. This considerably shortens the verification procedure.

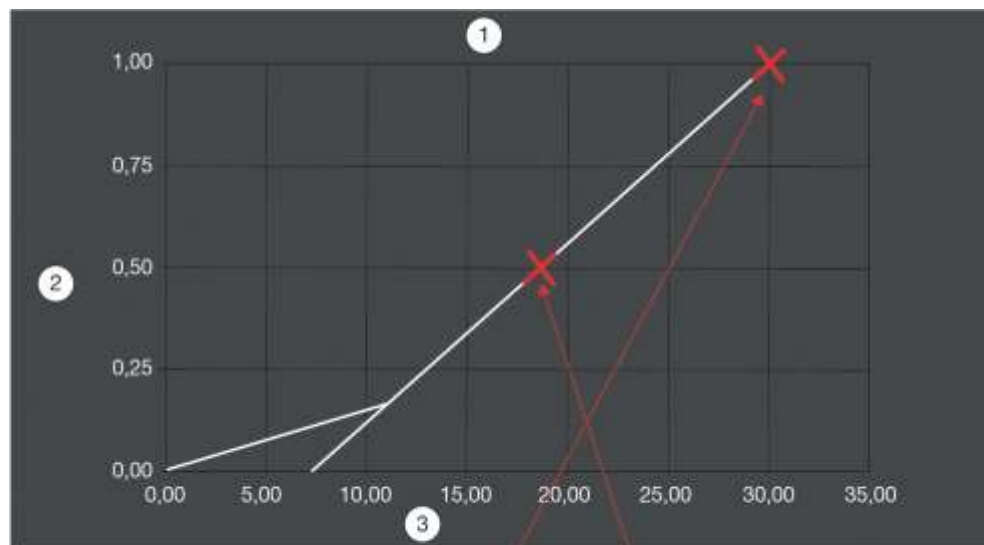

Δt in 100%		
20K	30K	
W	W	
12,5K	18,8K	Δt in 50%
105,2W	174,1W	P_{ZUL}
12,5K	18,8K	Δt in 50%
161,8W	267,8W	P_{ZUL}

- | | |
|---|---|
| 1 | Overheating temperature exceeded in enclosure |
| 2 | Enclosure height |
| 3 | Overheating of air in enclosure [K] |
| 4 | At overheating temperature Δt |

The table of power losses of the modular stand-alone distributors in the Power losses section shows the power losses that can be dissipated in modular stand-alone distributors. The values can be used to display the temperature rise curve of the air inside the enclosure, see graph.

It must be checked that the permissible operating ambient temperatures of the equipment and switchgear are not exceeded by the temperature rise curve occurring during operation. The devices' installation height must also be taken into account.

To enable a verification to be carried out according to this procedure for stand-alone distributors other than those listed, the procedure is shown in detail here.

For enclosures differentiated according to the 'Calculation method' table, column 4 and 5, the temperature rise of the air inside the enclosure is calculated according to the formulas in columns 1 to 3.

The associated factors and exponents can be found in columns 6 to 10. The formula symbols, units and designations are described in the following table.

For multi-field switchgear and controlgear assemblies with vertical partitions, the temperature rise of the air inside the enclosure must be determined separately for each field.

If enclosures without vertical partitions or individual fields have an effective cooling area of more than 11.5 m² or a width of more than about 1.5 m, they are

divided into fictitious fields for the calculation, the dimensions of which correspond to the values mentioned above.

Table: Calculation method, formulas and parameters according to IEC 60890

1	2	3	4	5	6	7	8	9	10	11
Calculation formulas			Housing		Parameter					Characteristic
Effective cooling surface A_e	Overheating of air inside		Effective cooling surface A_e		Factors				Exponent	Recording the overheating characteristic
	in half of the enclosure's height	on the roof area of the enclosure			b	k	d	c		
$A_e = \hat{a}(A_0 * b)$ (1)	$\Delta t_{0,5} = k * d * P^x$ (2)	$\Delta t_{1,0} = c * \Delta t_{0,5}$ (3)	$> 1.25 \text{ m}^2$	Enclosure without air vents Enclosure with air vents	Table 3	Pict. 3 Pict. 5	Table 4 Table 5	Pict. 4 Pict. 6	0.804 0.715	see 5.2.4.1
			$\leq 1.25 \text{ m}^2$	Enclosure without air vents		Pict. 7	-	Pict. 8	0.804	see 5.2.4.2

➤ For formula symbols, units and designations, see the following table.

Necessary data for determining the temperature rise

Formula symbols	Unit	Designation
A_0	m^2	Individual areas of the enclosure - external sides
A_b	m^2	Enclosure base area
A_e	m^2	Effective cooling surface of the enclosure
b	-	Area factor
c	-	Temperature-distribution factor
d	-	Factor for the temperature rise with internal horizontal dividers
f	-	Height / base area factor
g	-	Height / width factor
h	m	Enclosure height
k	-	Enclosure constant
n	-	Number of internal horizontal dividers (up to 3)
P	W	Effective power loss of equipment built into the enclosure
w	m	Enclosure width
x	-	Exponent
t	K	Temperature rise of the air inside the enclosure in general
$\Delta t_{0,5}$	K	Temperature rise of the air inside 1/2 the height of the enclosure
$\Delta t_{0,75}$	K	Temperature rise of the air inside 3/4 the height of the enclosure
$\Delta t_{1,0}$	K	Temperature rise of the air on the roof area of the enclosure

Heating characteristics in enclosures

Heating characteristics in enclosures with an effective cooling surface $A_e > 1.25 \text{ m}^2$

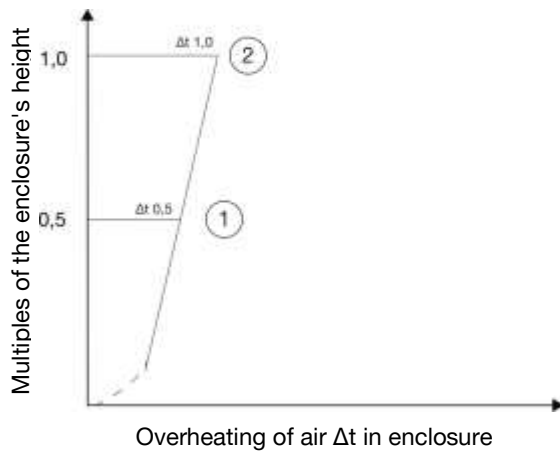

- 1 Half height

- 2 Roof

Heating characteristics in enclosures with an effective cooling surface $A_e \leq 1.25 \text{ m}^2$

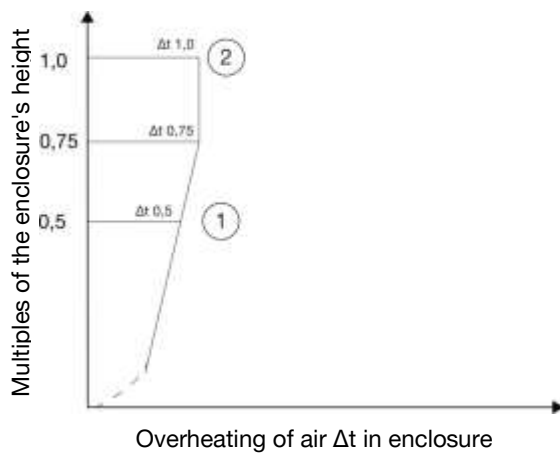

- 1 Half height

- 2 Roof

Factors and interdependencies

Area factor b as a function of the installation type

Installation type	Area factor b
Free roof area	1.4
Covered roof area	0.7
Unobstructed sides, e.g.: front, rear and side areas	0.9
Covered sides, e.g.: Rear in the case of a wall installation	0.5
Sides in the case of central enclosures	0.5
Base area	Not taken into account

Factor d for enclosures without ventilation openings and without an effective cooling surface $A_e > 1.25 \text{ m}^2$

Number of horizontal dividers	0	1	2	3
Factor d	1.00	1.05	1.15	1.30

Factor d for enclosures without ventilation openings and **with** an effective cooling surface $A_e \leq 1.25 \text{ m}^2$

Number of horizontal dividers	0	1	2	3
Factor d	1.00	1.05	1.10	1.15

Enclosure constant k for enclosures with ventilation openings and an effective cooling surface $A_e > 1.25 \text{ m}^2$

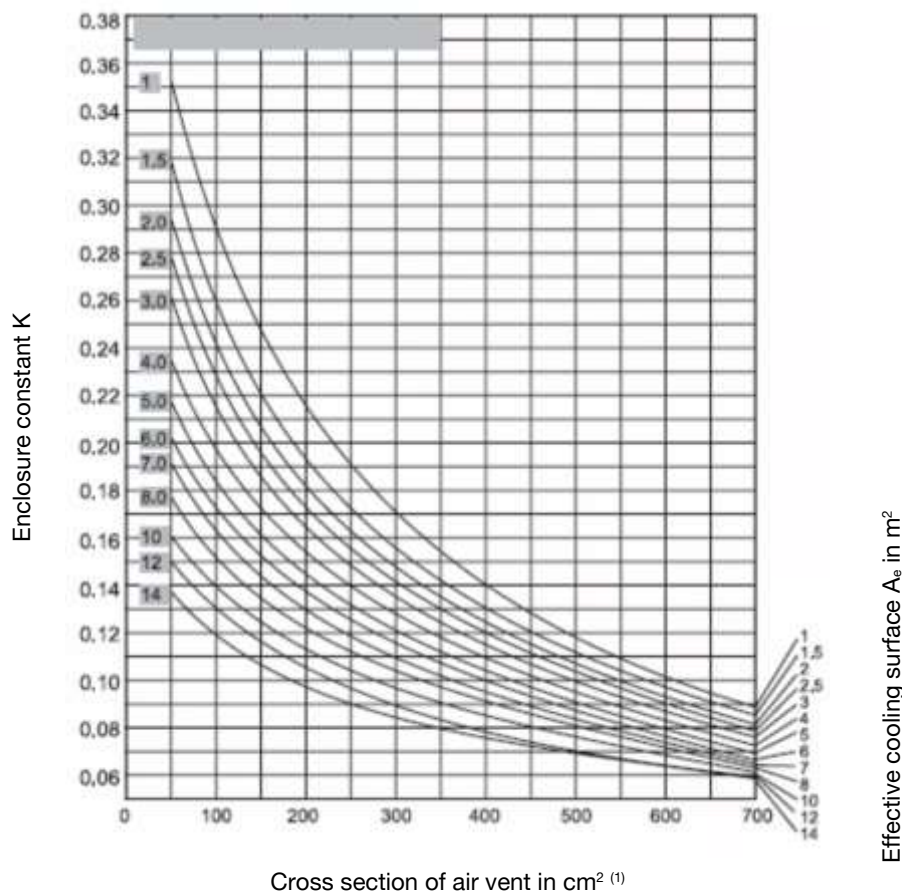

1) The cross-section of the associated air vents should be at least 1.1 times the cross-section of the air vents

Temperature distribution factor c for enclosures with ventilation openings and an effective cooling surface $A_e > 1.25 \text{ m}^2$

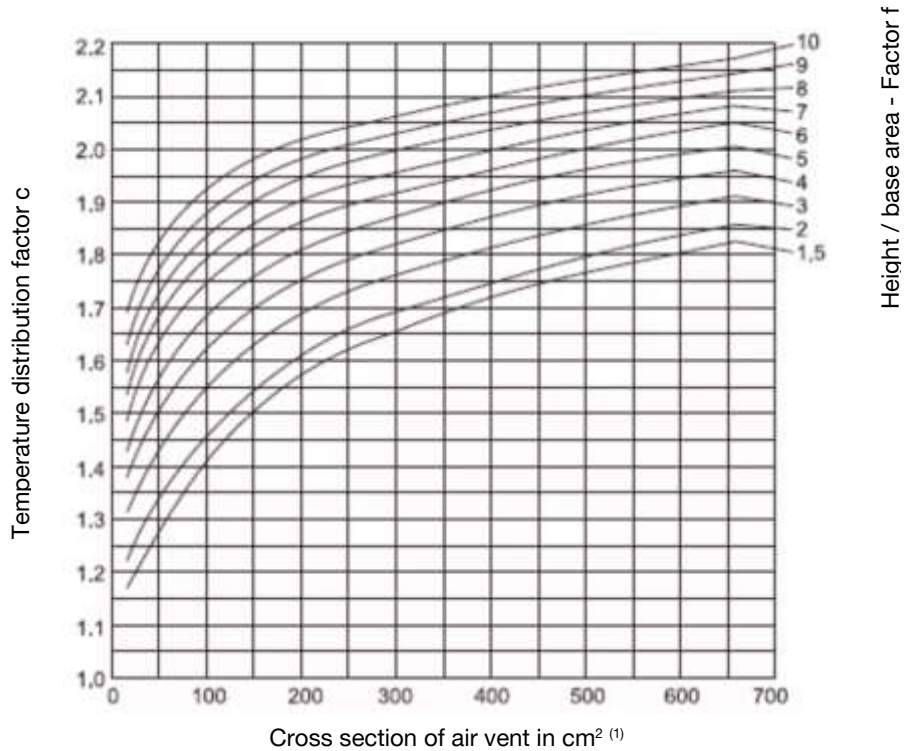

¹) The cross-section of the associated air vents should be at least 1.1 times the cross-section of the air vents

Enclosure constant k for enclosures without ventilation openings and an effective cooling surface $A_e > 1.25 \text{ m}^2$

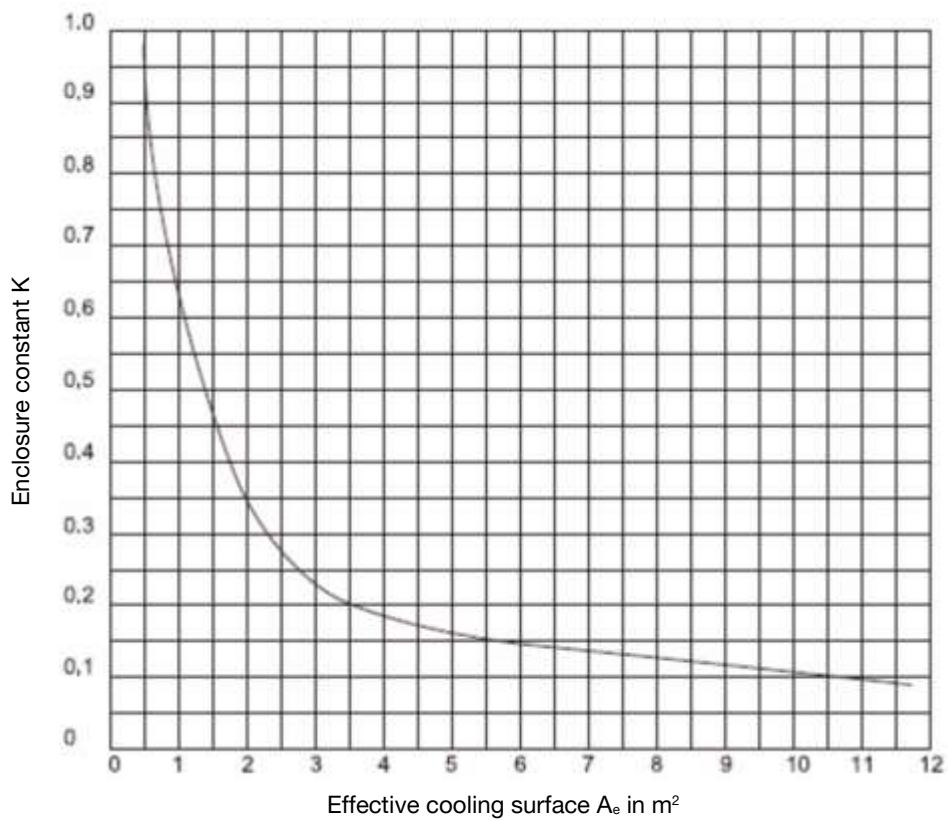

Temperature distribution factor c for enclosures without ventilation openings and an effective cooling surface $A_e > 1.25 \text{ m}^2$

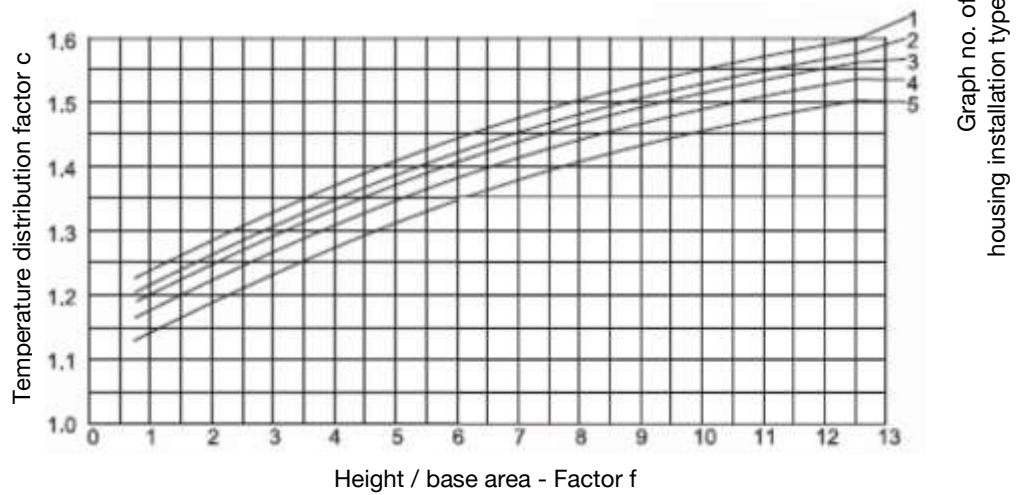

Housing installation type	Graph no.
Single enclosure free on all sides	1
Single enclosure for wall installation	3
End enclosure, free standing	2
End enclosure for wall installation	4
Central enclosure, free standing	3
Central enclosure for wall installation	5
Central enclosure for wall installation with covered roof area	4

Enclosure constant k for enclosures without ventilation openings and an effective cooling surface $A_e \leq 1.25 \text{ m}^2$

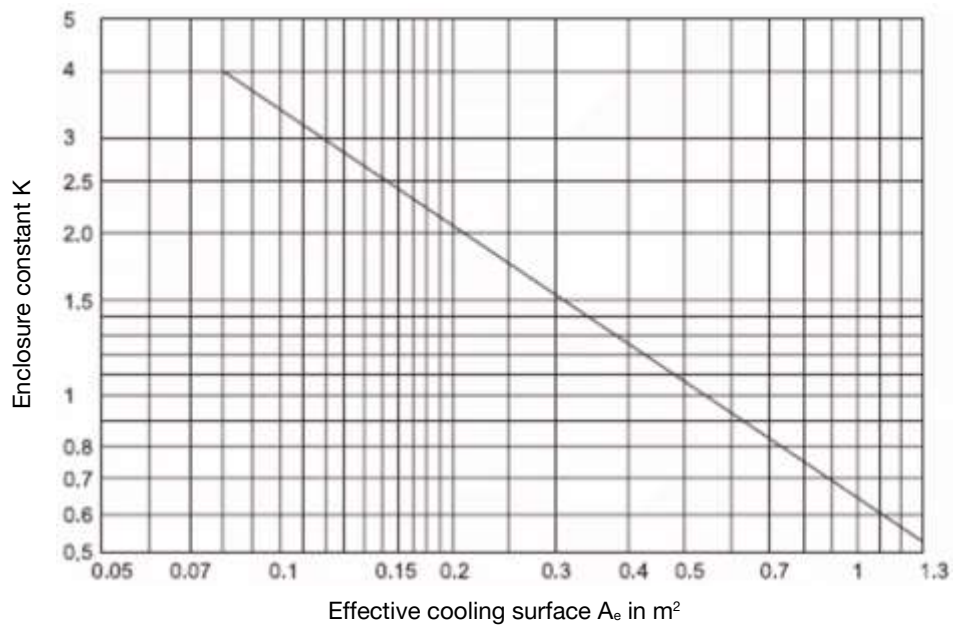

Temperature distribution factor c for enclosures without ventilation openings and an effective cooling surface $A_e \leq 1.25 \text{ m}^2$

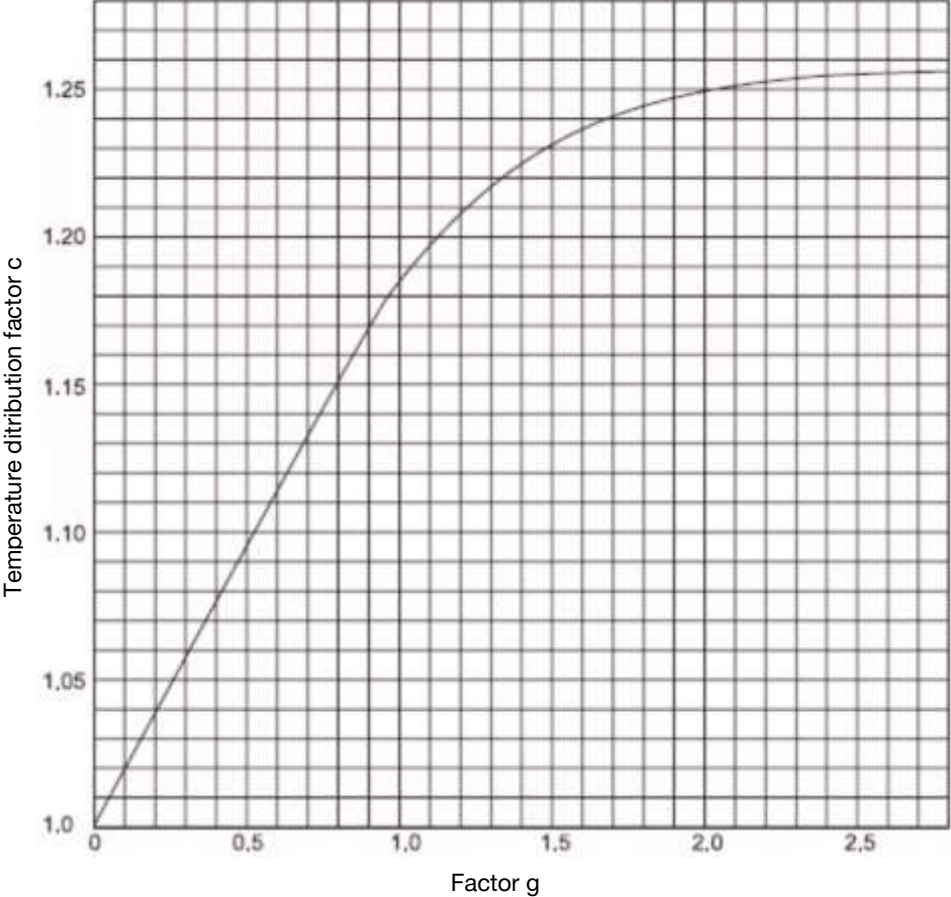

Form for calculating the temperature rise of the air in enclosures

Calculation of overheating of the air in the enclosure				
Customer/Unit Enclosure type				
Dimensions relevant for heating	Height Width Depth	mm mm mm	Installation type: Air vents yes/no Number of horizontal dividers	

Effective cooling surface		Dimensions	A_0	Area factor b, according to table	$A_0 \times b$
		m x m	m ²		m ²
		2	3	4	5
	Roof area				
	Front				
	Back				
Left side surface					
Right side surface					
$A_e = S (A_0 \times b) =$					

Effective cooling surface A_e	
$> 1,25 \text{ m}^2$	$\leq 1,25 \text{ m}^2$
$f = \frac{h^{1,25}}{A_e}$	$g = \frac{h}{w}$
= _____	= _____

Air vents	(cm ²)
Enclosure constant k	
Factor for horizontal dividers d	
Effective performance loss P	(W)
$P^* = P \dots\dots\dots$	
$Dt_{0,5} = k \cdot d \cdot P^*$	(K)
Temperature distribution factor c	
$Dt_{1,0} = c \times Dt_{0,5}$	(K)

Heating characteristic:

Enclosure

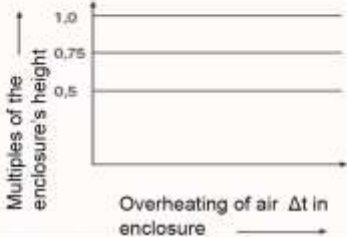

Example of calculation of the temperature rise of the air in enclosures

Calculation

For entries, see the form in the example:

- The effective cooling surface A_e is calculated from the sum of the products of the individual areas and the area factor. The individual areas are calculated from the housing dimensions, the relevant area factor b is taken from table 9.
- The temperature rise of the air $\Delta t_{0.5}$ formula (2) from table 'Calculation method, application, formulas and parameters according to IEC 60890', column 2:
 $\Delta t_{0.5} = k \times d \times P^x$ factor k , according to table 39-15, column 7, at $A_e > 1.25 \text{ m}^2$, according to figure 34: for $A_e = 6.64 \text{ m}^2$: $k = 0.135$ factor d , according to table 39-15, column 8, at $A_e > 1.25 \text{ m}^2$, according to table 39-18: Number of horizontal partitions = 0: $d = 1.0$ Actual power loss (according to guidelines) $P = 300 \text{ W}$. Exponent x from table 39-15, column 10 where $A_e > 1.25 \text{ m}^2$: $x = 0.804$

This results in formula (2) above:

- **$\Delta t_{0.5} = k \times d \times P^x = 0.135 \times 1.0 \times 300^{0.804}$**
- **$\Delta t_{0.5} = 13.24 \text{ K} = 13.2 \text{ K}$**

The temperature rise of the air $\Delta t_{1.0}$ formula (3) from table 'Calculation method, application, formulas and parameters according to IEC 60890', column 3:

$\Delta t_{1.0} = c \times \Delta t_{0.5}$ = factor c ,

according to table 39-15, column 9, with $A_e > 1.25 \text{ m}^2$, according to fig. 35:

$$f = \frac{h^{1.35}}{A_b} = \frac{2.2^{1.35}}{1.0 \cdot 0.5} = 5.80$$

Thus from fig. 35, curve 1: $c = 1.44$

Used in formula (3): **$\Delta t_{1.0} = c \times \Delta t_{0.5} = 1.44 \times 13.24 = 19.07 \text{ K} \approx 19.1 \text{ K}$**

The heating characteristics for enclosures are calculated with $A_e > 1.25 \text{ m}^2$

(Figure 'Heating characteristics in enclosures with an effective cooling surface $A_e > 1.25 \text{ m}^2$)

The calculation results are assessed.

- It must be determined whether the equipment in the enclosure can operate properly with both the specified currents and at the calculated temperature rises, taking the enclosure's ambient temperature into account. If this is not the case, change the parameters and repeat the calculation.
- Individual enclosures, free on all sides, without ventilation openings or horizontal partitions inside. Effective power loss of built-in equipment:
 $P = 300 \text{ W}$

Form filled in according to the calculation in the example

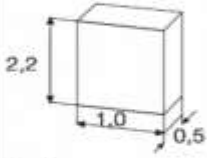
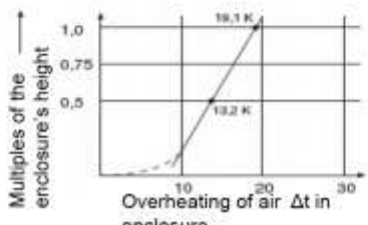
Calculation of overheating of the air in the enclosure							
Customer/Unit Enclosure type		Example Single Enclosure					
Dimensions relevant for heating		Height	2200	mm	Installation type: free on all sides Air vents <input checked="" type="checkbox"/> yes/no Number of horizontal dividers 0		
		Width	1000	mm			
Effective cooling surface				Dimensions	A_0	Area factor b, according to table	$A_0 \times b$ (Col. 3) x (Col. 4)
				m x m	m ²		
			2	3	4	5	
		Roof area	1,0 x 0,5	0,500	1,4	0,700	
		Front	1,0 x 2,2	2,200	0,9	1,980	
		Back	1,0 x 2,2	2,200	0,9	1,980	
		Right side surface	0,5 x 2,2	1,100	0,9	0,990	
				$A_e = S (A_0 \times b) =$		6,640	
Effective cooling surface A_e							
$> 1,25 \text{ m}^2$			$\leq 1,25 \text{ m}^2$				
$f = \frac{h^{1,25}}{A_0}$			$g = \frac{h}{w}$				
$= \frac{2,2^{1,25}}{1,0 \times 0,5} = 5,80$			$=$				
Air vents	(cm ²)	0					
Enclosure constant k		0,135					
Factor for horizontal dividers d		1,0					
Effective performance loss P	(W)	300					
$P^* = P \dots$		98,09					
$D_{0,5} = k \cdot d \cdot P^*$	(K)	13,24 = 13,2 K					
Temperature distribution factor c		1,44					
$D_{1,0} = c \times D_{0,5}$	(K)	19,07 = 19, K					
Heating characteristic:							
Enclosure							

5.2.5 Permissible power loss of enclosures

General information

The permissible power loss (P_{perm}) specified for distribution boards enclosed on all sides without ventilation openings and without horizontal separating walls with roughly even distribution of the thermal load.

The temperature rise of the air in the enclosure ΔT is specified in 75 % and in 50 % of the enclosure's height.

Guide to using the tables

Enclosure IP55				Permissible power loss P_{perm} for enclosures without ventilation openings							
Reference	Height H	Width W	Depth D	Temperature rise ΔT of free standing enclosure according to IEC/TR 60890:2014						% of enclosure height	
	[mm]	[mm]	[mm]	10 K	15 K	20 K	25 K	30 K	35 K		
				[W]	[W]	[W]	[W]	[W]	[W]		
1	FN...	1900	450	800/730*	95.4	158.0	226.0	298.3	374.2	453.2	100
					119.1	197.2	282.0	372.2	466.9	565.5	75
		1900	700	800/730*	122.4	202.7	289.9	382.6	480.0	581.4	100
					147.8	244.8	350.1	462.1	579.7	702.2	75

The table is basically designed so that in the first step, the user determines which temperature rise s/he can allow in the enclosure. This permissible temperature rise strongly depends on the built-in equipment and its position. To determine the permissible power loss, the external temperature must be defined and documented.

- (1) Define the type of enclosure you have selected.
- (2) Define the installation type: installed on or in the wall.
- (3) Define the permitted temperature rise.
- (4) Determine whether you would like to allow this temperature at 100 % of the enclosure's height or at 75 % of the enclosure's height.
- (5) In the table, find the value indicating how large the total power loss of the installed components may be.

Example 1:

If a temperature rise of 25 K in half (50 %) of the enclosure's height is permitted, components with a power loss of 42.1 W may be installed. With an assumed external temperature of 20 °C, the enclosure heats up to 55 °C.

Example 2:

If a temperature rise of 25 K in 3/4 (75 %) of the enclosure's height is permitted, components with a power loss of 32.2 W may be installed.

ATTENTION

Above half or 3/4 of the enclosure's height, higher temperatures than the selected temperature rises occur. This must be observed when positioning the equipment.

Enclosure IP55				Permissible power loss P_{perm} for enclosures without ventilation openings						
Reference	Height H	Width W	Depth D	Temperature rise ΔT of free standing enclosure according to IEC/TR 60890:2014						% of enclosure height
	[mm]	[mm]	[mm]	10 K	15 K	20 K	25 K	30 K	35 K	
				[W]	[W]	[W]	[W]	[W]	[W]	
FN...	1900	450	400/330*	57.7	95.5	136.5	180.2	226.1	273.8	100
				74.7	123.6	176.8	233.3	292.7	354.6	75
	1900	700	400/330*	79.7	132.0	188.8	249.2	312.6	378.7	100
				101.9	168.7	241.2	318.4	399.5	483.8	75
	1900	900	400/330*	95.8	158.6	226.9	299.5	375.7	455.1	100
				120.4	199.3	285.1	376.3	472.0	571.8	75
	1900	1000	400/330*	103.8	171.9	245.8	324.5	407.0	493.1	100
				129.5	214.4	306.6	404.7	507.7	615.1	75
	1900	450	600/530*	77.6	128.4	183.7	242.4	304.2	368.4	100
				98.9	163.8	234.2	309.1	387.8	469.7	75
	1900	700	600/530*	101.3	167.7	239.9	316.6	397.2	481.1	100
				125.3	207.5	296.8	391.7	491.4	595.2	75
	1900	900	600/530*	120.1	198.8	284.3	375.3	470.8	570.3	100
				145.8	241.4	345.3	455.7	571.7	692.5	75
	1900	1000	600/530*	129.4	214.3	306.5	404.5	507.5	614.7	100
				155.9	258.1	369.1	487.2	611.2	740.4	75

*) installation depth (back plate to front cover)

Enclosure IP55				Permissible power loss P_{perm} for enclosures without ventilation openings						
Reference	Height H	Width W	Depth D	Temperature rise ΔT of free standing enclosure according to IEC/TR 60890:2014						% of enclosure height
	[mm]	[mm]	[mm]	10 K	15 K	20 K	25 K	30 K	35 K	
				[W]	[W]	[W]	[W]	[W]	[W]	
FN...	1900	450	800/730*	95.4	158.0	226.0	298.3	374.2	453.2	100
				119.1	197.2	282.0	372.2	466.9	565.5	75
	1900	700	800/730*	122.4	202.7	289.9	382.6	480.0	581.4	100
				147.8	244.8	350.1	462.1	579.7	702.2	75
	1900	900	800/730*	138.4	229.1	327.7	432.5	542.6	657.2	100
				164.8	272.9	390.4	515.2	646.4	783.0	75
	1900	1000	800/730*	146.0	241.7	345.7	456.3	572.4	693.3	100
				172.9	286.3	409.5	540.5	678.1	821.3	75
	2100	450	400/330*	64.7	107.2	153.3	202.4	253.9	307.5	100
				83.8	138.8	198.5	262.0	328.7	398.1	75
	2100	700	400/330*	83.7	138.6	198.2	261.6	328.2	397.5	100
				107.9	178.6	255.4	337.1	423.0	512.3	75
	2100	900	400/330*	100.4	166.3	237.9	314.0	393.9	477.14	100
				127.4	210.9	301.6	398.1	499.5	605.0	75
	2100	1000	400/330*	108.8	180.1	257.6	340.0	426.6	516.7	100
				137.0	226.8	324.4	428.1	537.1	650.5	75

*) installation depth (back plate to front cover)

Enclosure IP55				Permissible power loss P_{perm} for enclosures without ventilation openings						
Reference	Height H	Width W	Depth D	Temperature rise ΔT of free standing enclosure according to IEC/TR 60890:2014						% of enclosure height
	[mm]	[mm]	[mm]	10 K [W]	15 K [W]	20 K [W]	25 K [W]	30 K [W]	35 K [W]	
FN...	2100	450	600/530*	81.4	134.7	192.7	254.4	319.1	386.55	100
				104.7	173.3	247.9	327.2	410.4	497.1	75
	2100	700	600/530*	106.0	175.5	251.0	331.3	415.6	503.4	100
				132.4	219.2	313.5	413.7	519.0	628.7	75
	2100	900	600/530*	124.4	205.9	294.5	388.7	487.7	590.7	100
				152.5	252.6	361.3	476.8	598.2	724.6	75
	2100	1000	600/530*	131.9	218.4	312.3	412.3	517.2	626.4	100
				160.5	265.8	380.1	501.7	629.4	762.4	75
	2100	450	800/730*	99.9	165.5	236.6	312.3	391.8	474.6	100
				125.9	208.4	298.0	393.4	493.5	597.8	75
	2100	700	800/730*	126.4	209.4	299.4	395.2	495.8	600.6	100
				154.3	255.5	365.4	482.3	605.1	732.9	75
	2100	900	800/730*	143.5	237.5	339.7	448.4	562.5	681.4	100
				172.1	285.0	407.7	538.1	675.0	817.7	75
	2100	1000	800/730*	152.1	251.9	360.2	475.5	596.5	722.5	100
				181.5	300.6	429.9	567.4	711.8	862.2	75

*) installation depth (back plate to front cover)

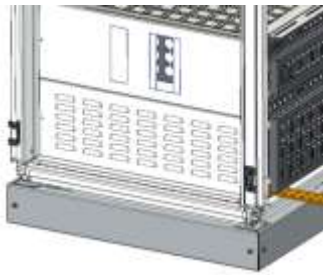

Front panel IP31	H	L	Air flow section
	[mm]	[mm]	[cm ²]
UC6010PL	100	600	25
UC6020PL	200	600	50
UC8010PL	100	800	32.5
UC8020PL	200	800	65

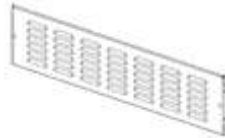
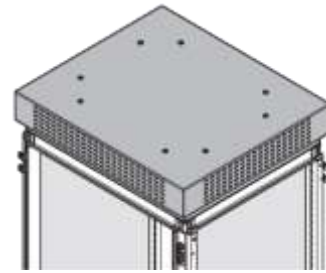

Enclosure IP30 with louver plate 100 mm height				Permissible power loss Pperm for enclosures with ventilation openings as mentioned above						
Reference	Height H [mm]	Width W [mm]	Depth D [mm]	Temperature rise ΔT of free standing enclosure according to IEC/TR 60890:2014						% of enclosure height
				10 K [W]	15 K [W]	20 K [W]	25 K [W]	30 K [W]	35 K [W]	
FN...										
...with UC6010PL	1900	700	400/330*	77.6	136.9	204.7	279.7	360.9	447.7	100
				109.1	192.4	287.7	393.1	507.2	629.2	75
...with UC8010PL	1900	900	400/330*	94.1	165.8	248.0	338.8	437.2	542.4	100
				129.3	228.0	341.0	465.8	601.1	745.7	75
...with UC6010PL	1900	1000	400/330*	97.6	172.1	257.4	351.7	453.8	563.0	100
				130.8	230.7	345.0	471.3	608.2	754.5	75
...with UC6010PL	1900	700	600/530*	101.8	179.4	268.3	366.6	473.0	586.8	100
				134.2	236.6	353.9	483.5	623.9	773.9	75
...with UC8010PL	1900	900	600/530*	123.6	218.0	326.0	445.4	574.7	712.9	100
				159.7	281.6	421.1	575.3	742.4	921.0	75
...with UC6010PL	1900	1000	600/530*	130.3	229.7	343.5	469.3	605.6	751.2	100
				162.9	287.2	429.5	586.8	757.2	939.3	75

*) installation depth (back plate to front cover)

***) cover plate with louvers in lower position

Enclosure IP30 with louver plate 100 mm height				Permissible power loss P_{perm} for enclosures with ventilation openings as mentioned above						
Reference	Height H	Width W	Depth D	Temperature rise ΔT of free standing enclosure ac- cording to IEC/TR 60890:2014						% of en- closure height
	[mm]	[mm]	[mm]	10 K [W]	15 K [W]	20 K [W]	25 K [W]	30 K [W]	35 K [W]	
FN...										
...with UC6010PL	1900	700	800/730*	123.6	217.9	325.8	445.1	574.4	712.6	100
				157.9	278.4	416.3	568.7	733.9	910.5	75
...with UC8010PL	1900	900	800/730*	130.4	229.9	343.8	469.8	606.2	752.0	100
				164.9	290.7	434.7	593.9	766.4	950.7	75
...with UC6010PL	1900	1000	800/730*	151.8	267.6	400.2	546.7	705.5	875.2	100
				184.2	324.7	485.6	663.4	856.2	1062.1	75
...with UC6010PL	2100	700	400/330*	77.6	136.9	204.7	279.7	360.9	447.7	100
				109.1	192.4	287.7	393.1	507.2	629.2	75
...with UC8010PL	2100	900	400/330*	91.0	160.5	240.0	327.9	423.1	524.8	100
				126.7	223.3	334.0	456.3	588.8	730.4	75
...with UC6010PL	2100	1000	400/330*	93.9	165.5	247.5	338.1	436.4	541.3	100
				127.7	225.2	336.7	460.0	593.6	736.4	75

*) installation depth (back plate to front cover)

**) cover plate with louvers in lower position

Enclosure IP30 with louver plate 100 mm height				Permissible power loss P_{perm} for enclosures with ventilation openings as mentioned above						
Reference	Height H	Width W	Depth D	Temperature rise ΔT of free standing enclosure ac- cording to IEC/TR 60890:2014						% of en- closure height
	[mm]	[mm]	[mm]	10 K [W]	15 K [W]	20 K [W]	25 K [W]	30 K [W]	35 K [W]	
FN...										
...with UC6010PL	2100	700	600/530*	97.6	172.1	257.4	351.7	453.8	563.0	100
				130.8	230.7	345.0	471.3	608.2	754.5	75
...with UC8010PL	2100	900	600/530*	113.8	200.6	300.0	409.9	529.0	656.2	100
				151.9	267.8	400.4	547.0	705.9	875.7	75
...with UC6010PL	2100	1000	600/530*	134.1	236.4	353.4	482.9	623.1	773.1	100
				171.3	302.0	451.6	617.0	796.2	987.7	75
...with UC6010PL	2100	700	800/730*	123.6	217.9	325.8	445.1	574.4	712.6	100
				157.9	278.4	416.3	568.7	733.9	910.5	75
...with UC8010PL	2100	900	800/730*	141.5	249.5	373.0	509.7	657.7	815.9	100
				178.9	315.4	471.6	644.3	831.5	1031.5	75
...with UC6010PL	2100	1000	800/730*	157.3	277.4	414.8	566.7	731.3	907.3	100
				196.7	346.9	518.7	708.6	914.5	1134.5	75

*) installation depth (back plate to front cover)

**) cover plate with louvers in lower position

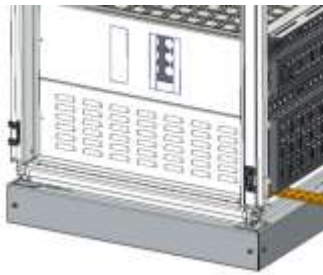

Front panel IP31	H	L	Air flow section
	[mm]	[mm]	[cm ²]
UC6010PL	100	600	25
UC6020PL	200	600	50
UC8010PL	100	800	32.5
UC8020PL	200	800	65

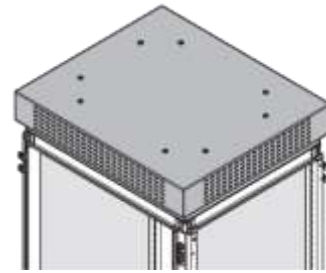

Enclosure IP30 with louver plate 200 mm height				Permissible power loss P _{perm} for enclosures with ventilation openings as mentioned above						
Reference	Height H [mm]	Width W [mm]	Depth D [mm]	Temperature rise ΔT of free standing enclosure according to IEC/TR 60890:2014						% of enclosure height
				10 K [W]	15 K [W]	20 K [W]	25 K [W]	30 K [W]	35 K [W]	
FN...										
...with UC6020PL	1900	700	400/330*	81.0	142.8	213.5	291.7	376.4	466.9	100
				116.3	205.1	306.7	419.1	540.8	670.9	75
...with UC8020PL	1900	900	400/330*	100.6	177.4	265.2	362.4	467.6	580.1	100
				142.0	250.4	374.4	511.5	660.0	818.8	75
...with UC6020PL	1900	1000	400/330*	100.2	176.7	264.2	361.0	465.8	577.9	100
				138.3	243.8	364.6	498.1	642.8	797.4	75
...with UC6020PL	1900	700	600/530*	104.3	183.9	275.0	375.8	484.9	601.6	100
				141.8	250.0	373.9	510.8	659.1	817.7	75
...with UC8020PL	1900	900	600/530*	127.5	224.8	336.2	459.4	592.8	735.4	100
				171.1	301.6	451.0	616.2	795.1	986.4	75
...with UC6020PL	1900	1000	600/530*	131.3	231.5	346.1	472.9	610.2	757.1	100
				170.1	299.8	448.4	612.6	790.5	980.7	75

*) installation depth (back plate to front cover)

**) cover plate with louvers in lower position

Enclosure IP30 with louver plate 200 mm height				Permissible power loss P_{perm} for enclosures with ventilation openings as mentioned above						
Reference	Height H	Width W	Depth D	Temperature rise ΔT of free standing enclosure according to IEC/TR 60890:2014						% of enclosure height
	[mm]	[mm]	[mm]	10 K [W]	15 K [W]	20 K [W]	25 K [W]	30 K [W]	35 K [W]	
FN...										
	1900	700	800/730*	124.3	219.2	327.7	447.8	577.8	716.9	100
				164.5	290.1	433.8	592.6	764.8	948.8	75
	1900	900	800/730*	144.1	254.1	380.0	519.2	670.0	831.1	100
				184.2	324.8	485.7	663.6	856.4	1062.4	75
	1900	1000	800/730*	153.6	270.8	405.0	553.3	714.0	885.8	100
				193.0	340.3	508.8	695.2	897.1	1113.0	75
	1900	700	400/330*	81.0	142.8	213.5	291.7	376.4	466.9	100
				116.3	205.1	306.7	419.1	540.8	670.9	75
	1900	900	400/330*	97.8	172.4	257.9	352.3	454.6	564.0	100
				139.5	245.9	367.7	502.3	648.2	804.1	75
	1900	1000	400/330*	96.7	170.6	255.0	348.5	449.7	557.9	100
				135.2	238.4	356.5	487.1	628.6	779.8	75

*) installation depth (back plate to front cover)

**) cover plate with louvers in lower position

Enclosure IP30 with louver plate 200 mm height				Permissible power loss P_{perm} for enclosures with ventilation openings as mentioned above						
Reference	Height H	Width W	Depth D	Temperature rise ΔT of free standing enclosure ac- cording to IEC/TR 60890:2014						% of en- closure height
	[mm]	[mm]	[mm]	10 K [W]	15 K [W]	20 K [W]	25 K [W]	30 K [W]	35 K [W]	
FN...										
	2100	700	600/530*	100.2	176.7	264.2	361.0	465.8	577.9	100
				138.3	243.8	364.6	498.1	642.8	797.4	75
	2100	900	600/530*	119.7	211.0	315.5	431.0	556.2	690.0	100
				164.4	289.9	433.5	592.2	764.2	948.1	75
	2100	1000	600/530*	134.9	237.8	355.7	485.9	627.1	777.9	100
				178.5	314.8	470.7	643.1	829.9	1029.6	75
	2100	700	800/730*	124.3	219.2	327.7	447.8	577.8	716.9	100
				164.5	290.1	433.8	592.6	764.8	948.8	75
	2100	900	800/730*	156.4	275.8	412.5	563.5	727.2	902.2	100
				200.0	352.6	527.2	720.3	929.6	1153.2	75
	2100	1000	800/730*	158.3	279.2	417.5	570.4	736.1	913.1	100
				205.1	361.7	540.8	738.9	953.5	1182.9	75

*) installation depth (back plate to front cover)

**) cover plate with louvers in lower position

5.2.6 Power loss of busbar systems

Power loss table

The following table shows the continuous current-carrying capacity and power loss of busbar systems, valid for 3 busbars.

Cu busbar dimensions width x thickness [mm]	Cross section [mm]	Design [-field]	Length [mm]	Continuous current [A]	Power loss [W]
12 x 5	60	1	246.5	250	16
		2	496.5		33
		3	746.5		49
		4	996.5		66
		5	1246.5		82
2 x 12 x 5	2 x 60	1	246.5	355	16
		2	496.5		33
		3	746.5		50
		4	996.5		66
		5	1246.5		83
20 x 5	100	1	246.5	315	16
		2	496.5		31
		3	746.5		47
		4	996.5		63
		5	1246.5		79
20 x 10	200	1	246.5	500	20
		2	496.5		39
		3	746.5		59
		4	996.5		79
		5	1246.5		99
30 x 5	150	1	246.5	400	17
		2	496.5		34
		3	746.5		50
		4	996.5		67
		5	1246.5		84
30 x 10	300	1	246.5	630	21
		2	496.5		42
		3	746.5		62
		4	996.5		83
		5	1246.5		104
40 x 10	400	1	246.5	800	24.8
		2	496.5		50
		3	746.5		75.1
		4	996.5		100.3
		5	1246.5		125.4
60 x 10	600	1	246.5	1000	25.8
		2	496.5		52
		3	746.5		78.2
		4	996.5		104.4
		5	1246.5		130.5
80 x 10	800	1	246.5	1250	30.25
		2	496.5		60.9
		3	746.5		91.6
		4	996.5		122.3
		5	1246.5		153
100 x 10	1000	1	246.5	1500	34.8
		2	496.5		70.1
		3	746.5		105.44
		4	996.5		140.8
		5	1246.5		176

Cu busbar dimensions width x thickness [mm]	Cross section [mm]	Design [-field]	Length [mm]	Continuous current [A]	Power loss [W]
120 x 10	1200	1	246.5	1700	37.3
		2	496.5		75.1
		3	746.5		112.9
		4	996.5		150.7
		5	1246.5		188.5

Continuous current-carrying for bare Cu busbars, 3 x 1 main conductors L L L.

Continuous current and current heat losses/power loss for bare busbars made of E-Cu F 30 with rectangular cross-section in indoor systems at 35 °C and busbar temperatures as 65 °C.

Assessment basis: VDE 0660, part 500, IEC / EN IEC 61439 clauses 10.10.4.2 and 10.10.4.3.

5.3 Verification by tests of the original manufacturer

System

Rated voltage U_n	up to 415 V
Rated operational voltage U_e	up to 415 V
Rated insulation voltage U_i	up to 1000 V
Rated impulse withstand voltage U_{imp}	up to 12 kV
Rated frequency f_n	50 / 60 Hz
Rated short-time withstand current I_{cw}	up to 85 kA / 1 s
Rated peak withstand current I_{pk}	up to 187 kA
Mechanical impact protection	IK08 without door / IK10 full door or transparent door
Internal form of separation	1 / 2b / 3b / 4b
Compliant with	IEC / EN IEC 61439-1 / -2
Degree of protection of enclosure	IP30 / IP31 / IP43 / IP55
Depth of the enclosure (outer dimensions)	400 / 600 / 800 mm
Width of the enclosure (outer dimensions)	450 / 700 / 900 / 1000 mm
Height of the enclosure (outer dimensions)	1900 / 2100 mm

Derating factors examples for main incoming units at 35 °C ambient

Tested in highest form of segregation possible and highest possible position of the device providing the best level of safety. IP43 and IP55 achieve the same derating value, as they are technically similar.

ATTENTION

This is not a full view, exact values depend on many factors like size of the enclosure, position of the device inside the board, combination with other parts of the assembly etc. Full charts with tested results are available for download.

Type of main incoming device	I_n (device) [A]	IP rating of enclosure	I_{nA} [A]	derating factor I_{nA} / I_n
1600 A MCCB h1600	1600	30 / 31	1225	0.77
	1600	43 / 55	995	0.62
1600 A ACB HWT	1600	30 / 31	1600	1
	1600	43 / 55	1350	0.84
2000 A ACB HWT	2000	30 / 31	1600	0.8
	2000	43 / 55	1350	0.68
2500 A ACB HWT	2500	30 / 31	2400	0.96
	2500	43 / 55	1800	0.72
3200 A ACB HWT	3200	30 / 31	2500	0.78
	3200	43 / 55	2100	0.66
4000 A ACB HWT	4000	30 / 31	3150	0.79
	4000	43 / 55	2700	0.68

5.3.1 Incoming enclosures configurations

Principle

Two types of distributions must be considered:

- The ≤ 630 A and Form 1 distribution for which the user has the choice between "classic" shaped busbars or a main "transfer" busbar and vertical distribution busbars
- The > 630 A and Form 1 distribution for which the user must use the "transfer" busbar system.

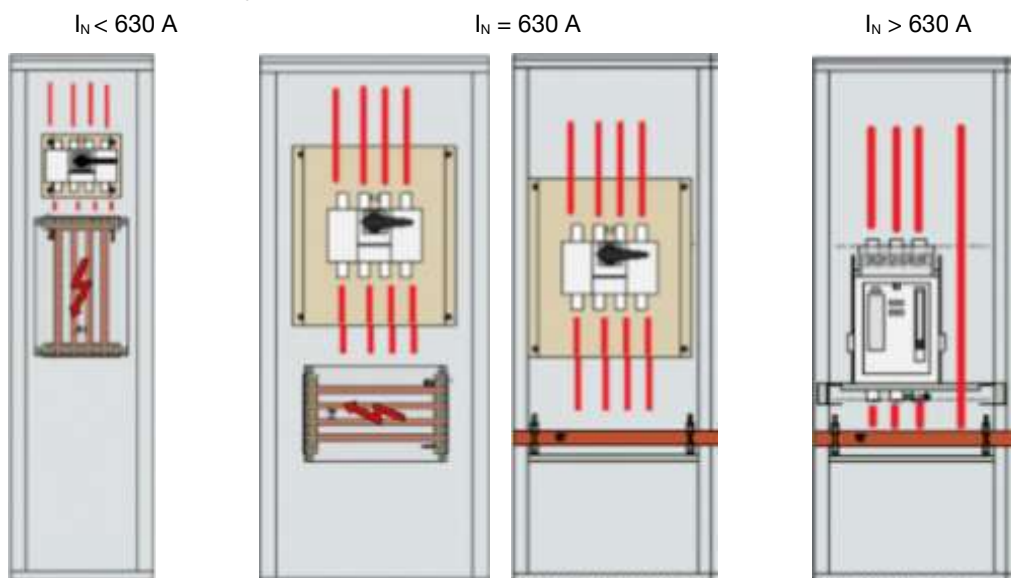

5.3.1.1 Distribution ≤ 630 A 'standard'

Principle

In these configurations, the distribution is made by a 'standard' busbar kit. It can be placed in a flexible manner anywhere in the layout and will suit to connect many outgoing circuits by cables.

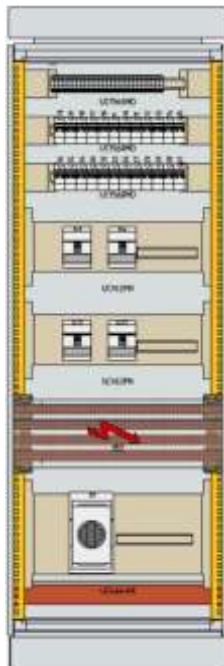

5.3.1.2 Distribution > 630 A 'transfer'

Principle

In these configurations, the distribution is carried out by main busbars called 'transfer' busbar. This busbar must ensure the connection between the copper bars connected to the outgoing terminals of the incoming device and the vertical distribution busbars which are used to connect the devices downstream of the incoming device.

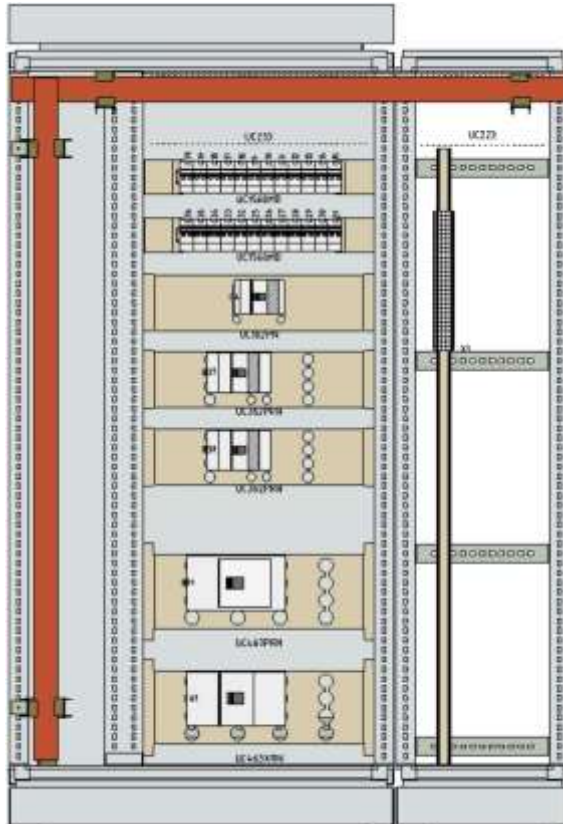

In the next pages several typical configurations to realize incoming and outgoing cells of the board are shown. Those typical configurations can be used to design a compliant board with Hager design verification. The tested values are provided in full. Changes on the design are acceptable only if derivable from tested designs.

5.3.1.3 Neutral point treatment

TN-S System

For TN-S System, a choice between 4P devices or 3P devices is possible.

4P devices

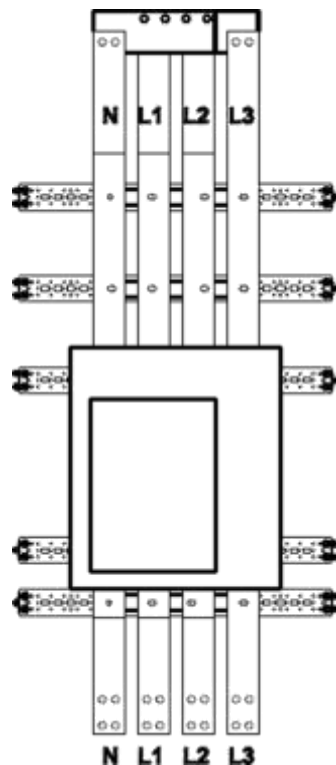

- In case of 4P devices, the N is located left, connected to terminals of the device.
- The connection of PE is made next to the cable incoming area, preferably to a perforated copper bar (e.g. UC922) that is fixed directly to the frame of the cell.

3P devices

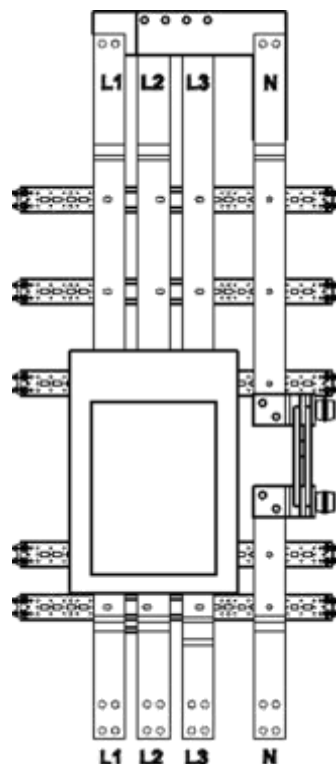

- In case of 3P devices, N is designed as N-link next to the MCCB, to replace the 4th pole. Due to the position of the device inside the mounting kit, the N is located to the right of the device.

TN-C System

For TN-C System, 3P devices must be used.

PEN linked next to the MCCB

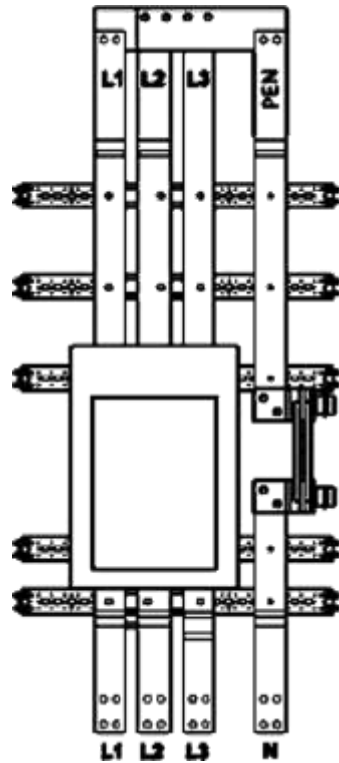

- In TN-C system the PEN is designed as a link next to the MCCB, to replace the 4th pole. Due to the position of the device inside the mounting kit, the PEN is located to the right of the device.

PEN mounted horizontally

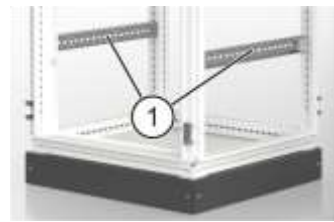

1 UC*FU profile

- Alternatively, for the most economical solution the PEN can be mounted horizontally. Preferably the PEN is a perforated copper bar (e.g. UC968) that is fixed directly to the frame of the cell, on the rear vertical profiles. The maximum dimension is 2000 A, single bar only, maximum thickness of 10 mm, maximum height of 125 mm. The bar has to be supported by a UC*FU profile, mounted on the frame.

5.3.1.4 Single incoming

5.3.1.4.1 Single ACB incoming compartment

Principle

The position of the breaker and the busbar is defined by:

- The nominal current
- The type of connection: by cable or BTS (busbar trunking system)
- The orientation (incoming from top or bottom)

The set of drawings needed to produce the copper connections according the certified configuration is provided by Hager, downloadable via the software hagerCAD. The ACBs range in the offer is limited to 4000 A devices.

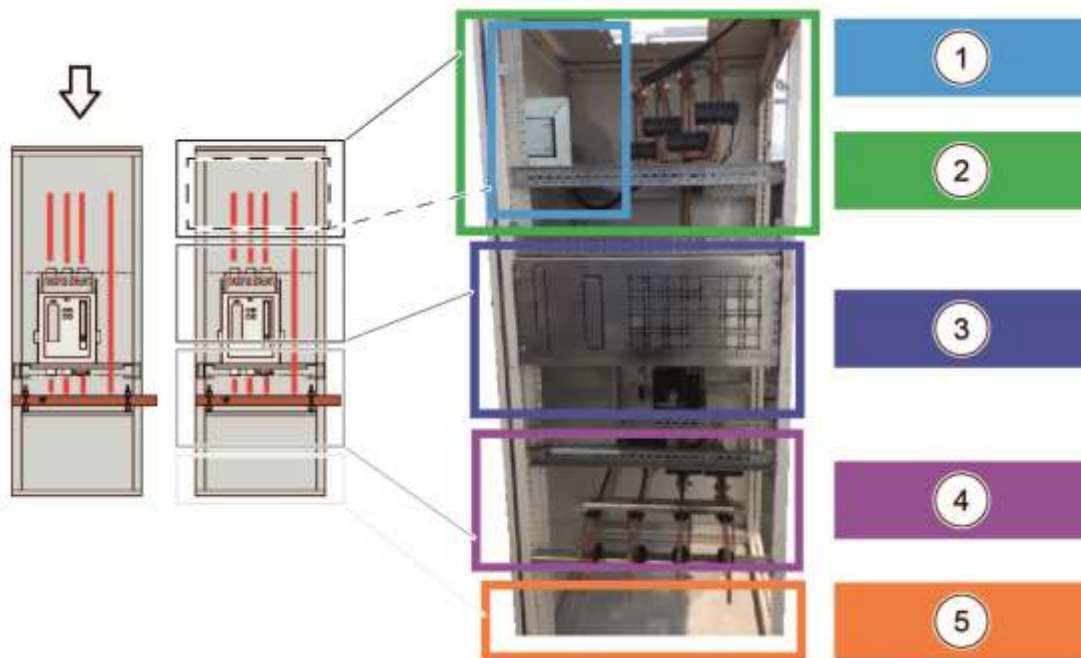

1	Space for modular devices
2	Space for incoming connections
3	Space for the ACB
4	Space for the connections from ACB to "transfer" busbar
5	Space available for other devices or reserve / ventilation

Single ACB incoming ≤ 1600 A

These maximum values are defined by the incoming device and main busbar, not considering the outgoing circuits.

Rated current of the assembly I_{nA}	up to 1600 A
Rated conditional short-circuit current I_{cc}	up to 85 kA
Rated impulse withstand voltage U_{imp}	up to 12 kV
Depth of the enclosure	600 / 800 mm
Width of the enclosure	700 / 900 / 1000 mm
Height of the enclosure	1900 / 2100 mm
Mounting orientation of the device	vertical
Mounting types of protection devices	fixed / draw-out
Connection type	cable (top/bottom) / BTS (top)
Internal form of separation	1 / 2b / 3b / 4b
Service Index levels	IS111 - IS332

Single ACB incoming ≤ 2000 A

These maximum values are defined by the incoming device and main busbar, not considering the outgoing circuits.

Rated current of the assembly I_{nA}	up to 2000 A
Rated conditional short-circuit current I_{cc}	up to 85 kA
Rated impulse withstand voltage U_{imp}	up to 12 kV
Depth of the enclosure	800 mm
Width of the enclosure	700 / 900 / 1000 mm
Height of the enclosure	1900 / 2100 mm
Mounting orientation of the device	vertical
Mounting types of protection devices	fixed / draw-out
Connection type	BTS (top)
Internal form of separation	1 / 2b / 3b / 4b
Service Index levels	IS111 - IS332

Single ACB incoming ≤ 4000 A

These maximum values are defined by the incoming device and main busbar, not considering the outgoing circuits.

Rated current of the assembly I_{nA}	up to 4000 A
Rated conditional short-circuit current I_{cc}	up to 85 kA
Rated impulse withstand voltage U_{imp}	up to 12 kV
Depth of the enclosure	800 mm
Width of the enclosure	900 / 1000 mm
Height of the enclosure	1900 / 2100 mm
Mounting orientation of the device	vertical
Mounting types of protection devices	fixed / draw-out
Connection type	BTS (top)
Internal form of separation	1 / 2b / 3b / 4b
Service Index levels	IS111 - IS332

5.3.1.4.2 MCCB 800 A ≤ 1600 A incoming

Principle

The areas reserved in the MCCB incoming compartment are similar to those in the ACB incoming configurations.

The downstream connection area is used to connect the MCCB to the horizontal busbar and to position the busbar which will make the connection with the adjoining enclosure (left or right). The height occupied by the downstream connection area is variable depending on the MCCB and the height of the bars in the busbar.

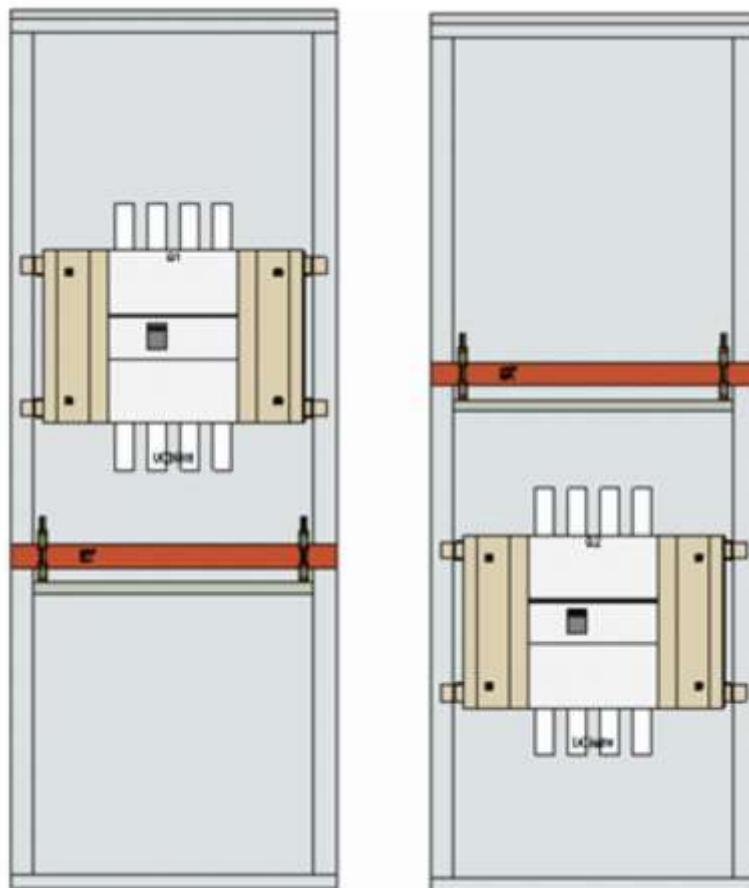

Single MCCB incoming ≤ 1600 A

These maximum values are defined by the incoming device and main busbar, not considering the outgoing circuits.

Rated current of the assembly I_{nA}	up to 1600 A
Rated conditional short-circuit current I_{cc}	up to 70 kA
Rated impulse withstand voltage U_{imp}	up to 8 kV
Depth of the enclosure	400 / 600 / 800 mm
Width of the enclosure	700 / 900 / 1000 mm
Height of the enclosure	1900 / 2100 mm
Mounting orientation of the device	vertical
Mounting types of protection devices	fixed
Connection type	cable (top/bottom) / BTS (top)
Internal form of separation	1 - 2b - 3b - 4b
Service Index levels	IS111 - IS211

5.3.1.4.3 Switch 630 A ≤ 1600 A incoming

Principle

The areas reserved in the disconnecter / change over switch incoming compartment are similar to those in the ACB incoming configurations.

The space not occupied by the connection space, the head unit kit and the busbar is available for all other kits.

Configurations including this type of device are only available up to Form 2.

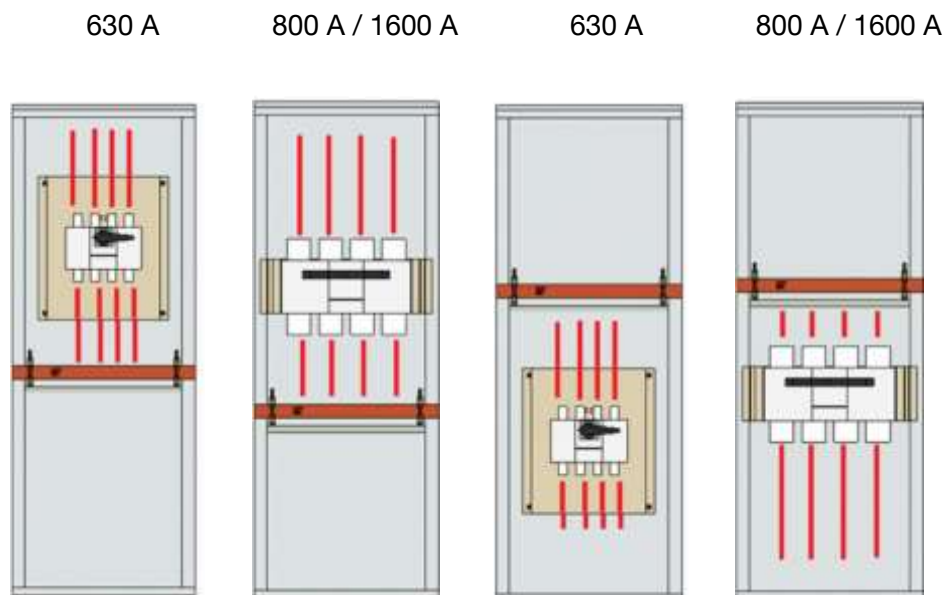

Disconnecting switch / change over switch

These maximum values are defined by the incoming device and main busbar, not considering the outgoing circuits.

Rated current of the assembly I_{nA}	up to 1600 A
Rated short-time withstand current I_{cw} (kA / 1 s)	up to 50
Rated impulse withstand voltage U_{imp}	up to 12 kV
Depth of the enclosure	400 / 600 / 800 mm
Width of the enclosure	700 / 900 / 1000 mm
Height of the enclosure	1900 / 2100 mm
Mounting orientation of the device	vertical
Mounting types of protection devices	fixed
Connection type	cable (top/bottom) / BTS (top)
Internal form of separation	1 / 2b
Service Index levels	IS111 - IS211

5.3.1.5 Multiple incoming sources on common busbar

Principle

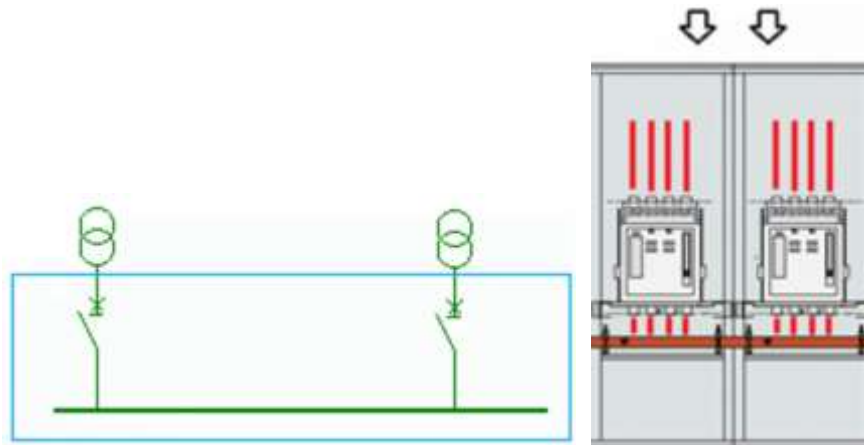

NOTE

The multiple incoming configuration can be positioned in the following matter:

Combinations of this configurations are also possible in case of more than 2 incoming devices. Balancing of the load is required and correct dimension of the common main busbar.

All incomers placed left or right side of the assembly.

The main busbar must be rated to the current of both devices together.

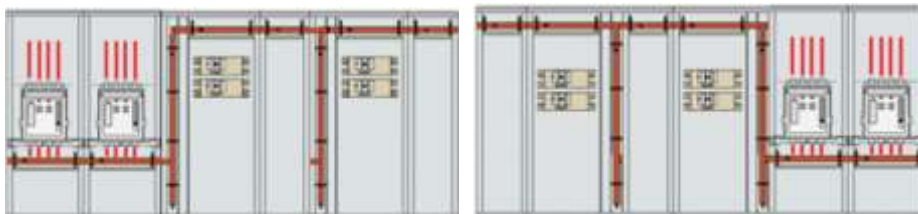

All incomers placed in the center of the assembly.

If the outgoing circuits are balanced equally on both sides, the main busbar can be same rating as the incoming current of a single supply device (both devices must be same current rating).

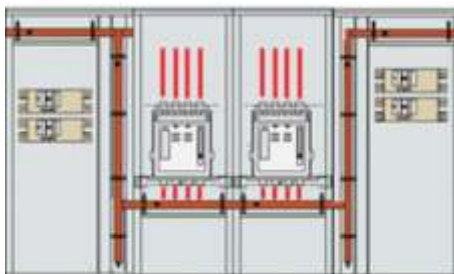

All incomers placed in the left and right end of the assembly.

If the outgoing circuits are balanced equally on both sides, the main busbar can be same rating as the incoming current of a single supply device (both devices must be same current rating).

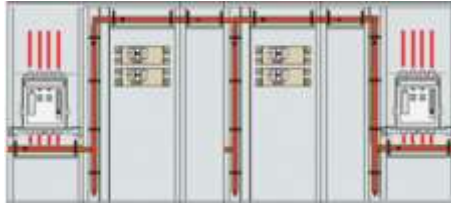

Multiple ACB incoming $\leq 2 \times 2000 \text{ A}$

These maximum values are defined by the incoming device and main busbar, not considering the outgoing circuits.

Rated current of the assembly I_{nA}	up to 4000 A
Rated conditional short-circuit current I_{cc}	up to 85 kA
Rated impulse withstand voltage U_{imp}	up to 12 kV
Depth of the enclosure	800 mm
Width of the enclosure	700 / 900 / 1000 mm
Height of the enclosure	1900 / 2100 mm
Mounting orientation of the device	vertical
Mounting types of protection devices	fixed / draw-out
Connection type	cable (top/bottom) / BTS (top)
Internal form of separation	1 / 2b / 3b / 4b
Service Index levels	IS111 - IS332

5.3.1.5.1 Incoming on multiple MCCB / Switch ≤ 630 A

Principle

With up to 2 incoming feeders on MCCB / Switch ≤ 630 A the classic busbar can be used as distribution busbar.

When there are more than 2 incoming feeders, classic busbar distribution is no longer suitable, in this case, transfer busbar must be used.

The classic busbar can be placed in horizontal or vertical manner.

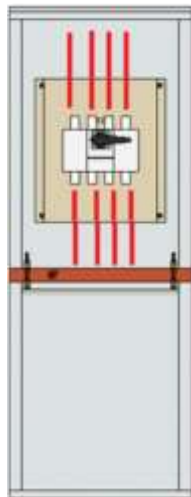

Multiple MCCB incoming $\leq 2 \times 1600$ A

These maximum values are defined by the incoming device and main busbar, not considering the outgoing circuits.

Rated current of the assembly I_{nA}	up to 3200 A
Rated conditional short-circuit current I_{cc}	up to 70 kA
Rated impulse withstand voltage U_{imp}	up to 8 kV
Depth of the enclosure	400 / 600 / 800 mm
Width of the enclosure	700 / 900 / 1000 mm
Height of the enclosure	1900 / 2100 mm
Mounting orientation of the device	vertical
Mounting types of protection devices	fixed
Connection type	cable (top/bottom) / BTS (top)
Internal form of separation	1 / 2b
Service Index levels	IS111 - IS211

Multiple MCCB incoming $\leq 2 \times 630$ A

These maximum values are defined by the incoming device and main busbar, not considering the outgoing circuits.

Rated current of the assembly I_{nA}	up to 1250 A
Rated conditional short-circuit current I_{cc}	up to 70 kA
Rated impulse withstand voltage U_{imp}	up to 8 kV
Depth of the enclosure	400 / 600 / 800 mm
Width of the enclosure	700 / 900 / 1000 mm
Height of the enclosure	1900 / 2100 mm

Mounting orientation of the device	vertical
Mounting types of protection devices	fixed / plug in / draw out
Connection type	cable (top/bottom) / BTS (top)
Internal form of separation	1 / 2b / 3b
Service Index levels	IS111 - IS232

Multiple load break switch incoming $\leq 2 \times 630 \text{ A}$

These maximum values are defined by the incoming device and main busbar, not considering the outgoing circuits.

Rated current of the assembly I_{nA}	up to 1250 A
Rated conditional short-circuit current I_{cc}	up to 50 kA
Rated impulse withstand voltage U_{imp}	up to 8 kV
Depth of the enclosure	400 / 600 / 800 mm
Width of the enclosure	700 / 900 / 1000 mm
Height of the enclosure	1900 / 2100 mm
Mounting orientation of the device	vertical
Mounting types of protection devices	fixed
Connection type	cable (top/bottom) / BTS (top)
Internal form of separation	1 / 2b
Service Index levels	IS111 - IS211

5.3.1.6 Multiple incoming with switch between two busbar systems

5.3.1.6.1 Main incoming devices > 630 A

Configuration of main incoming devices > 630 A

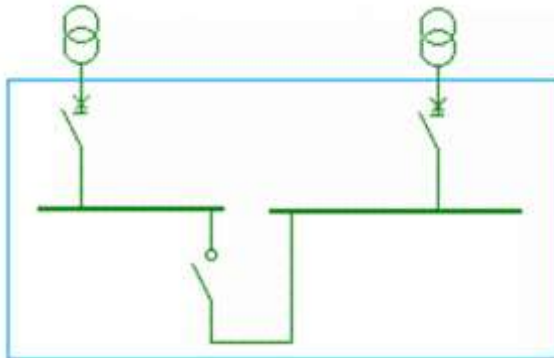

The configuration must be carried out with transfer busbar.

If the incoming feeders are positioned in the centre, the coupling switch must be positioned between the 2 incoming feeders.

The coupling switch cabinet must have a busbar duct to allow the connection of the right-hand ACB to be connected to the coupling switch.

The outgoing feeders positioned on the left have the outputs on the left (left-hand cable sheath) and the outgoing feeders positioned on the right have the outputs on the right (right-hand cables-heat).

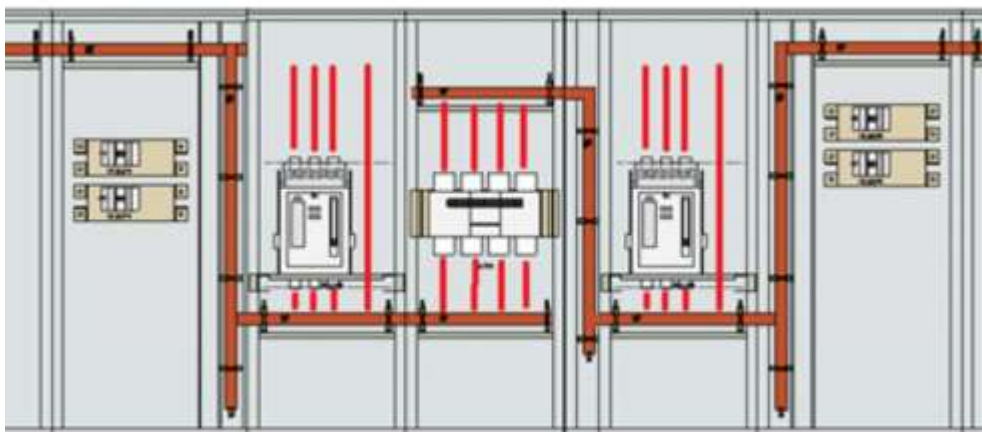

If the incoming feeders are positioned at the ends, the coupling switch must be positioned between the 2 busbars.

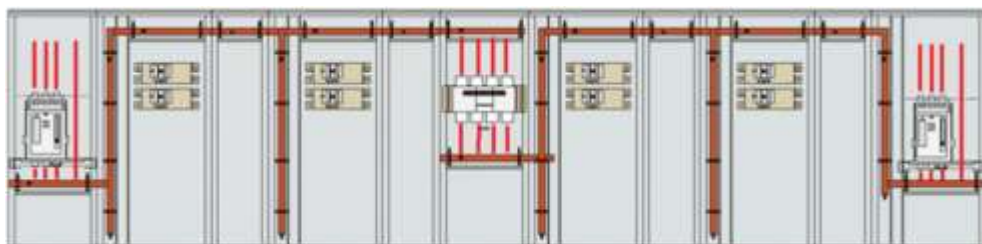

Maximum values

These maximum values are defined by the incoming device, load break switch and main busbar, not considering the outgoing circuits.

Rated current of the assembly I_{nA}	up to 1600 A
Rated short-time withstand current I_{cw} (kA /1 s)	up to 50
Rated impulse withstand voltage U_{imp}	up to 8 kV
Depth of the enclosure	400 / 600 / 800 mm
Width of the enclosure	700 / 900 / 1000 mm
Height of the enclosure	1900 / 2100 mm
Mounting orientation of the device	vertical
Mounting types of protection devices	fixed
Connection type	cable (top/bottom) / BTS (top)
Internal form of separation	1 / 2b
Service Index levels	IS111 - IS211

5.3.1.6.2 Main incoming devices ≤ 630 A

Configuration of main incoming devices ≤ 630 A

The configuration can be done with classic busbar. In case of more than two incoming devices, transfer busbar must be selected.

There are no specific positioning rules to apply for the devices but the same logic as with incoming devices higher than 630 A.

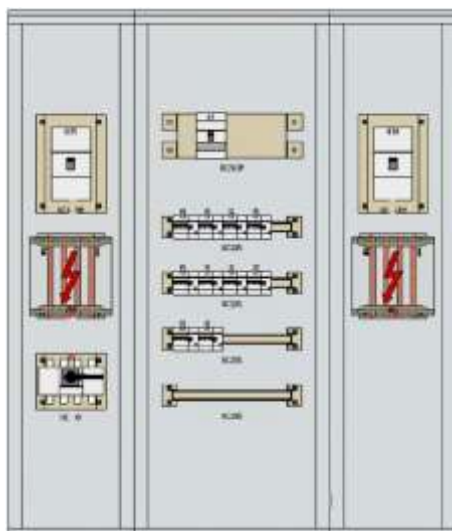

Maximum values

These maximum values are defined by the incoming device, load break switch and main busbar, not considering the outgoing circuits.

Rated current of the assembly I_{nA}	up to 630 A
Rated conditional short-circuit current I_{cc}	up to 50 kA
Rated impulse withstand voltage U_{imp}	up to 8 kV
Depth of the enclosure	400 / 600 / 800 mm
Width of the enclosure	700 / 900 / 1000 mm
Height of the enclosure	1900 / 2100 mm
Mounting orientation of the device	vertical
Mounting types of protection devices	fixed
Connection type	cable (top/bottom) / BTS (top)
Internal form of separation	1 / 2b
Service Index levels	IS111 - IS211

5.3.1.7 Multiple incoming with switch over

5.3.1.7.1 Main incoming ≤ 630 A from transformer and ATS backup supply

Configuration

- 'Normal' power supply to classic busbar
- 'Backup' power supply with ATS change over switch on second classic busbar

Both devices build inside the same enclosure.

When there are more than 2 normal incoming feeders, conventional distribution is no longer suitable, in this case, transfer busbar is applied.

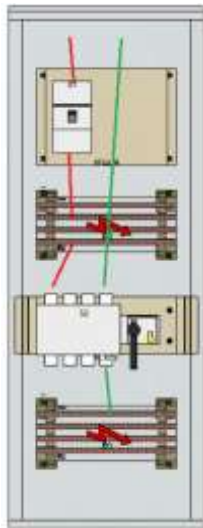

Maximum values

These maximum values are defined by the incoming device, change-over switch and main busbar, not considering the outgoing circuits.

Rated current of the assembly I_{nA}	up to 630 A
Rated short-time withstand current I_{cw} (kA /1 s)	up to 50
Rated impulse withstand voltage U_{imp}	up to 8 kV
Depth of the enclosure	600 / 800 mm
Width of the enclosure	900 / 1000 mm
Height of the enclosure	2100 mm
Mounting orientation of the device	vertical
Mounting types of protection devices	fixed
Connection type	cable (top/bottom) / BTS (top)
Internal form of separation	1 / 2b
Service Index levels	IS111 - IS211

5.3.1.7.2 Main incoming > 630 A from transformer and ATS backup supply

Configuration

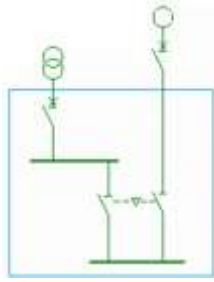

- 'Normal' power supply
- 'Backup' power supply with ATS change over switch.

Both devices build inside the same enclosure.

- 'Normal' Busbar systems set in the left enclosures
- 'Backup' Busbar systems set in the right enclosures

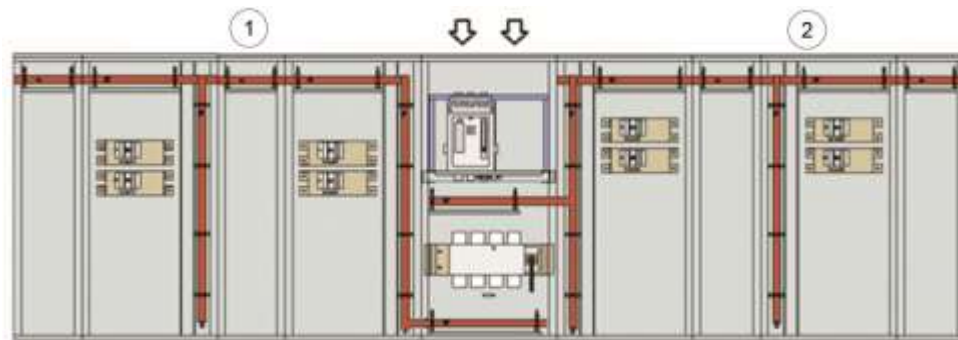

- | | |
|---|---------------|
| 1 | Normal busbar |
| 2 | Backup busbar |

- 'Normal' Busbar systems set in the right enclosures.
- 'Backup' Busbar systems set in the left enclosures.

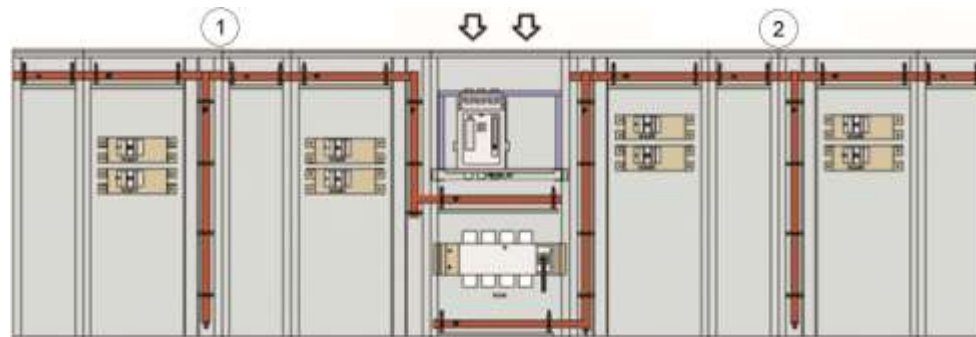

- | | |
|---|---------------|
| 1 | Backup busbar |
| 2 | Normal busbar |

Maximum values

These maximum values are defined by the incoming device, change-over switch and main busbar, not considering the outgoing circuits.

Rated current of the assembly I_{nA}	up to 1600 A
Rated short-time withstand current I_{cw} (kA /1 s)	up to 50
Rated impulse withstand voltage U_{imp}	up to 8 kV
Depth of the enclosure	800 mm
Width of the enclosure	900 / 1000 mm
Height of the enclosure	2100 mm
Mounting orientation of the device	vertical
Mounting types of protection devices	fixed
Connection type	cable (top/bottom) / BTS (top)
Internal form of separation	1 / 2b
Service Index levels	IS111 - IS211

5.3.1.7.3 Main incoming > 630 A from transformer and ACB backup supply

Configuration

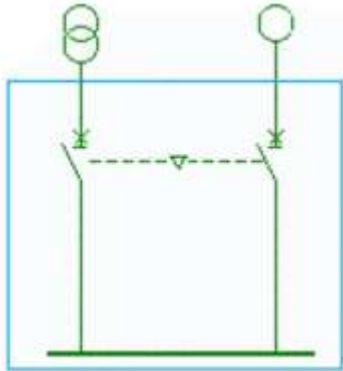

- 'Normal' power supply to transfer busbar
- 'Backup' power supply by ACB on same busbar

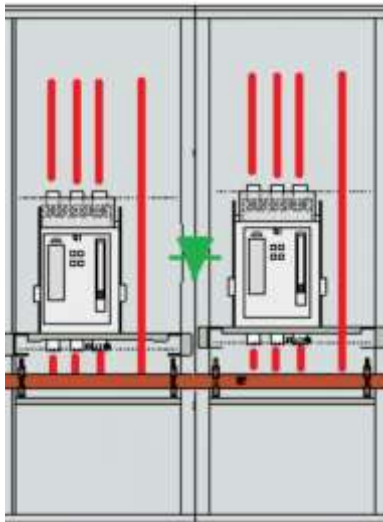

The ACBs must be positioned side by side to allow mechanical interlocking between the 2 devices.

Single ACB incoming ≤ 1600 A

These maximum values are defined by the incoming device and main busbar, not considering the outgoing circuits.

Rated current of the assembly I_{nA}	up to 1600 A
Rated conditional short-circuit current I_{cc}	up to 85 kA
Rated impulse withstand voltage U_{imp}	up to 12 kV
Depth of the enclosure	600 / 800 mm
Width of the enclosure	700 / 900 / 1000 mm
Height of the enclosure	1900 / 2100 mm
Mounting orientation of the device	vertical
Mounting types of protection devices	fixed / draw-out
Connection type	cable (top/bottom) / BTS (top)
Internal form of separation	1 / 2b / 3b / 4b
Service Index levels	IS111 - IS332

Single ACB incoming ≤ 2000 A

These maximum values are defined by the incoming device and main busbar, not considering the outgoing circuits.

Rated current of the assembly I_{nA}	up to 2000 A
Rated conditional short-circuit current I_{cc}	up to 85 kA
Rated impulse withstand voltage U_{imp}	up to 12 kV
Depth of the enclosure	800 mm
Width of the enclosure	700 / 900 / 1000 mm
Height of the enclosure	1900 / 2100 mm
Mounting orientation of the device	vertical
Mounting types of protection devices	fixed / draw-out
Connection type	BTS (top)
Internal form of separation	1 / 2b / 3b / 4b
Service Index levels	IS111 - IS332

Single ACB incoming ≤ 4000 A

These maximum values are defined by the incoming device and main busbar, not considering the outgoing circuits.

Rated current of the assembly I_{nA}	up to 4000 A
Rated conditional short-circuit current I_{cc}	up to 85 kA
Rated impulse withstand voltage U_{imp}	up to 12 kV
Depth of the enclosure	800 mm
Width of the enclosure	900 / 1000 mm
Height of the enclosure	1900 / 2100 mm
Mounting orientation of the device	vertical
Mounting types of protection devices	fixed / draw-out
Connection type	BTS (top)
Internal form of separation	1 / 2b / 3b / 4b
Service Index levels	IS111 - IS332

5.3.1.7.4 Main incoming ≤ 630 A from transformer and MCCB backup supply

Configuration

- 'Normal' power supply to classic busbar.
- 'Backup' power supply on same busbar.

Both devices build inside the same enclosure.

When there are more than 2 normal incoming feeders, conventional distribution is no longer suitable, in this case, transfer busbar is applied.

The ACBs must be positioned side by side to allow mechanical interlocking between the 2 devices.

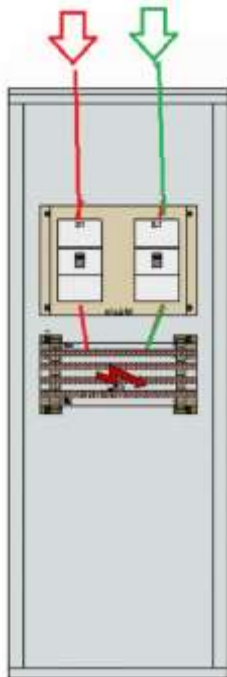

Multiple MCCB incoming $\leq 2 \times 630$ A

These maximum values are defined by the incoming device and main busbar, not considering the outgoing circuits.

Rated current of the assembly I_{nA}	up to 630 A
Rated conditional short-circuit current I_{cc}	up to 70 kA
Rated impulse withstand voltage U_{imp}	up to 8 kV
Depth of the enclosure	400 / 600 / 800 mm
Width of the enclosure	700 / 900 / 1000 mm
Height of the enclosure	1900 / 2100 mm
Mounting orientation of the device	vertical
Mounting types of protection devices	fixed / plug in / draw out
Connection type	cable (top/bottom) / BTS (top)
Internal form of separation	1 / 2b / 3b
Service Index levels	IS111 - IS232

5.3.1.8 Multiple incoming with change over

5.3.1.8.1 Main incoming > 630 A and ATS to secondary distribution busbar system

Configuration

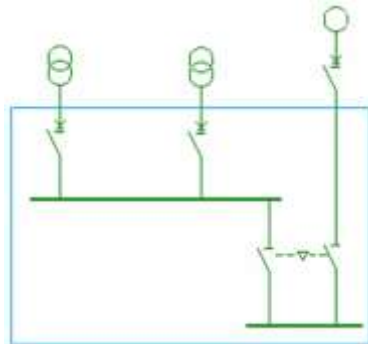

In this configuration, same rules apply as for the configuration of single incoming device and ATS, and single ACB incoming cell for second supply.

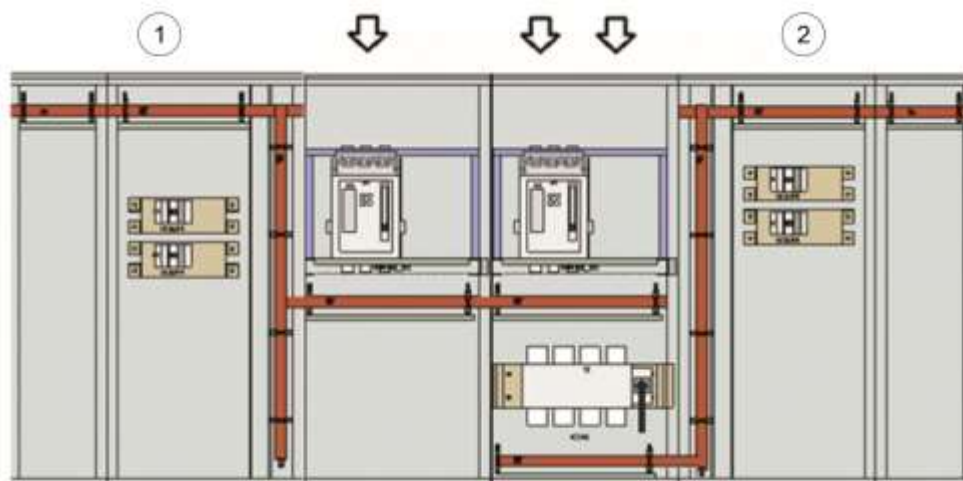

- 1 Normal busbar
- 2 Backup busbar

Maximum values

These maximum values are defined by the incoming device, change-over switch and main busbar, not considering the outgoing circuits.

Rated current of the assembly I_{nA}	up to 1600 A
Rated short-time withstand current I_{cw} (kA / 1 s)	up to 50
Rated impulse withstand voltage U_{imp}	up to 8 kV
Depth of the enclosure	800 mm
Width of the enclosure	900 / 1000 mm
Height of the enclosure	2100 mm
Mounting orientation of the device	vertical
Mounting types of protection devices	fixed
Connection type	cable (top/bottom) / BTS (top)
Internal form of separation	1 / 2b
Service Index levels	IS111 - IS211

5.3.1.8.2 Main incoming ≤ 630 A and ATS to secondary distribution busbar system**Configuration**

Same principle as for devices > 630 A. The usage of classic busbar is not possible, transfer busbar must be used.

Maximum values

These maximum values are defined by the incoming device, change-over switch and main busbar, not considering the outgoing circuits.

Rated current of the assembly I_{nA}	up to 630 A
Rated short-time withstand current I_{cw} (kA / 1 s)	up to 50
Rated impulse withstand voltage U_{imp}	up to 8 kV
Depth of the enclosure	400 / 600 / 800 mm
Width of the enclosure	900 / 1000 mm
Height of the enclosure	1900 / 2100 mm
Mounting orientation of the device	vertical
Mounting types of protection devices	fixed
Connection type	cable (top/bottom) / BTS (top)
Internal form of separation	1 / 2b
Service Index levels	IS111 - IS211

5.3.1.8.3 Multiple main incoming > 630 A + coupling + ATS on 3 busbars

Configuration

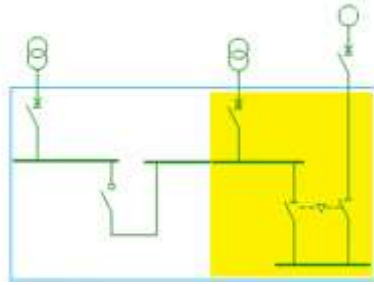

For this incoming feeder combination, follow the same principles as the combination with one main incomer and ATS (yellow part of the drawing) and position the second incoming device and the coupling switch in the cabinets on the other busbar side.

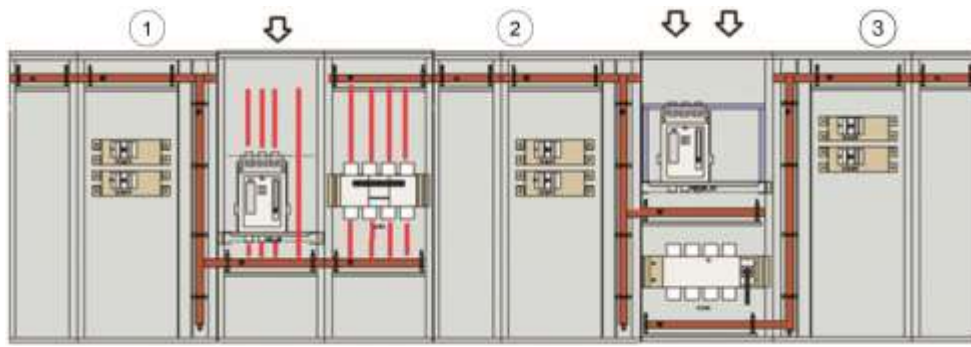

1	Normal busbar 2
2	Normal busbar 1
3	Backup busbar

Maximum values

These maximum values are defined by the incoming device, change-over switch and main busbar, not considering the outgoing circuits.

Rated current of the assembly I_{nA}	up to 1600 A
Rated short-time withstand current I_{cw} (kA / 1 s)	up to 50
Rated impulse withstand voltage U_{imp}	up to 8 kV
Depth of the enclosure	800 mm
Width of the enclosure	900 / 1000 mm
Height of the enclosure	2100 mm
Mounting orientation of the device	vertical
Mounting types of protection devices	fixed
Connection type	cable (top/bottom) / BTS (top)
Internal form of separation	1 / 2b
Service Index levels	IS111 - IS211

5.3.1.8.4 Multiple main incoming ≤ 630 A + coupling + ATS on 3 busbars**Configuration**

Same principles and rules as for the configurations > 630 A.

Only transfer busbar applicable.

Maximum values

These maximum values are defined by the incoming device, change-over switch and main busbar, not considering the outgoing circuits.

Rated current of the assembly I_{nA}	up to 630 A
Rated short-time withstand current I_{cw} (kA / 1 s)	up to 50
Rated impulse withstand voltage U_{imp}	up to 8 kV
Depth of the enclosure	600 / 800 mm
Width of the enclosure	900 / 1000 mm
Height of the enclosure	2100 mm
Mounting orientation of the device	vertical
Mounting types of protection devices	fixed
Connection type	cable (top/bottom) / BTS (top)
Internal form of separation	1 / 2b
Service Index levels	IS111 - IS211

5.3.1.8.5 Multiple main incoming > 630 A and ACB backup supply on 2 busbars

Configuration

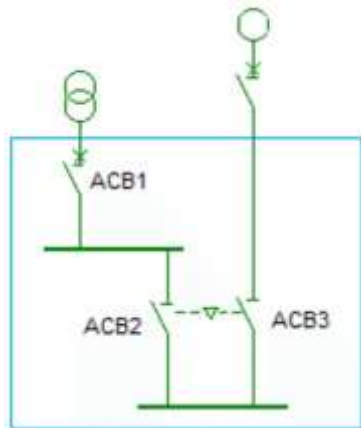

1 'Normal' power supply.

1 'Backup' power supply by ACB.

Interlock between 2 ACB.

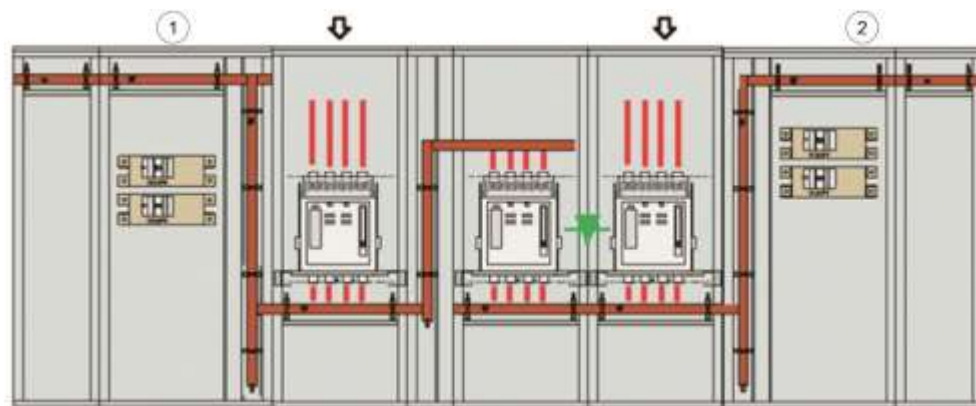

1 Normal busbar

2 Backup busbar

5.3.1.8.6 Multiple main incoming ≤ 630 A and MCCB backup supply on 2 busbars

Configuration

Same principles and rules as for the configurations > 630 A.

Only transfer busbar applicable.

5.3.2 Outgoing enclosures configurations

Derating factors examples for main outgoing units at 35 °C ambient

Tested in highest form of segregation possible and highest possible position of the device providing the best level of safety. IP43 and IP55 achieve the same derating value, as they are technically similar.

NOTICE

This is not a full view, exact values depend on many factors like size of the enclosure, position of the device inside the board, combination with other parts of the assembly etc. Full charts with tested results are available for download.

Main busbar in the top of the distribution section, 4000 A

	I_n (device) [A] Rated current of the device	IP rating of enclosure	Derating factor $F = I_{nc} / I_n$	I_{nc} [A] Rated current of a circuit	RDF Rated diversity factor	I_{ng} [A] Group rated current
Main busbar	4000	30 / 31	1	4000	-	-
busbar only	4000	43 / 55	0.85	3400	-	-
I _{nc} (X160 MCCB) -cable 1x70 mm ²	160	30 / 31	0.75	120	0.95	114
	160	43 / 55	0.66	105	0.95	100
I _{nc} (P160 MCCB) -cable 1x70 mm ²	160	30 / 31	0.88	140	0.95	133
	160	43 / 55	0.75	120	0.95	114
I _{nc} (x250 MCCB) -cable 1x120 mm ²	250	30 / 31	0.64	160	0.95	152
	250	43 / 55	0.52	130	0.95	124
I _{nc} (P250 MCCB) -cable 1x120 mm ²	250	30 / 31	0.74	185	0.95	176
	250	43 / 55	0.66	165	0.95	157
I _{nc} (X630 MCCB) -flexibar 2x(8x24x1) mm ²	630	30 / 31	0.56	350	0.95	333
	630	43 / 55	0.44	280	0.95	266
I _{nc} (P630 MCCB) -flexibar 2x(8x24x1) mm ²	630	30 / 31	0.62	390	0.95	371
	630	43 / 55	0.53	335	0.95	318

Main busbar in the top of the distribution section, 1600 A

	I_n (device) [A] Rated current of the device	IP rating of enclosure	Derating factor F = I_{nc} / I_n	I_{nc} [A] Rated current of a circuit	RDF Rated diversity factor	I_{ng} [A] Group rated current
Main busbar	1600	30 / 31	1	1600		
busbar only	1600	43 / 55	1	1600		
I _{nc} (x160 MCCB) -cable 1x70 mm ²	160	30 / 31	0.88	140	1	140
	160	43 / 55	0.72	115	0.87	100
I _{nc} (P160 MCCB) -cable 1x70 mm ²	160	30 / 31	1	160	1	160
	160	43 / 55	0.89	143	0.87	124
I _{nc} (x250 MCCB) -cable 1x120 mm ²	250	30 / 31	0.86	215	1	215
	250	43 / 55	0.75	187	0.87	163
I _{nc} (P250 MCCB) -cable 1x120 mm ²	250	30 / 31	0.86	215	1	215
	250	43 / 55	0.78	194	0.87	169
I _{nc} (x250 MCCB) -flexibar 3x20x1 mm	250	30 / 31	0.86	215	1	215
	250	43 / 55	0.75	187	0.87	163
I _{nc} (P250 MCCB) -flexibar 3x20x1 mm	250	30 / 31	0.96	239	1	239
	250	43 / 55	0.82	205	0.87	178
I _{nc} (P400 MCCB) -flexibar 8x24x1 mm	400	30 / 31	0.90	360	1	360
	400	43 / 55	0.80	320	0.87	278
I _{nc} (X630 MCCB) -flexibar 2x(8x24x1) mm ²	630	30 / 31	0.67	420	1	420
	630	43 / 55	0.57	360	0.87	313
I _{nc} (P630 MCCB) -flexibar 2x(8x24x1) mm ²	630	30 / 31	0.83	422	1	522
	630	43 / 55	0.71	450	0.87	392

5.3.2.1 Principle of outgoing enclosures configurations

Principle

For the outgoing circuits in the quadro evo system, there are numerous configuration options that can be adjusted in a flexible manner by using the dedicated system kits. A single outgoing compartment is limited to 1600 A nominal current, due to temperature rise limitations.

- One outgoing compartment is usually supplied by a horizontal main busbar, placed in the top or bottom of the assembly. From this horizontal bars, vertical distribution busbar is supplied, to ease the cabling of the outgoing circuits.
- The system kits to fix outgoing devices can support MCCBs, switches, fuse disconnectors, MCBs and other modular devices.
- All kits can be mixed and changed in position inside the enclosure (respecting the correct dimensions)
- The kits can be compartmentalized by segregation panels to achieve forms of segregation up to Form 4b.
- In the quadro evo system, the orientation of the devices can be horizontal or vertical, depending on the kit selected
- The depth of the enclosure defines the necessary kit's dimension.
- A dedicated cable compartment can be realized:
 - Behind the devices
 - Laterally in the same enclosure, by adding the separation profile in the 1000 mm wide board.
 - Laterally in a dedicated enclosure, preferably adding a 450 mm wide board.
- Inside the cable compartment, terminals, measuring CTs, PE bars and cable supports can be placed.

5.3.2.2 Outgoing enclosure horizontal orientation of MCCBs

Benefit of horizontal orientation

The benefit of the horizontal orientation is that the devices can be easily supplied by flexibars / cables coming from the distribution busbar (red color, left compartment) and wired with outgoing cables from a common cable compartment.

This configuration is the preferred solution for large outgoing devices as MCCBs, requiring big cable diameters.

Notice: All examples visualized without covers, for better understanding.

Forms of segregation

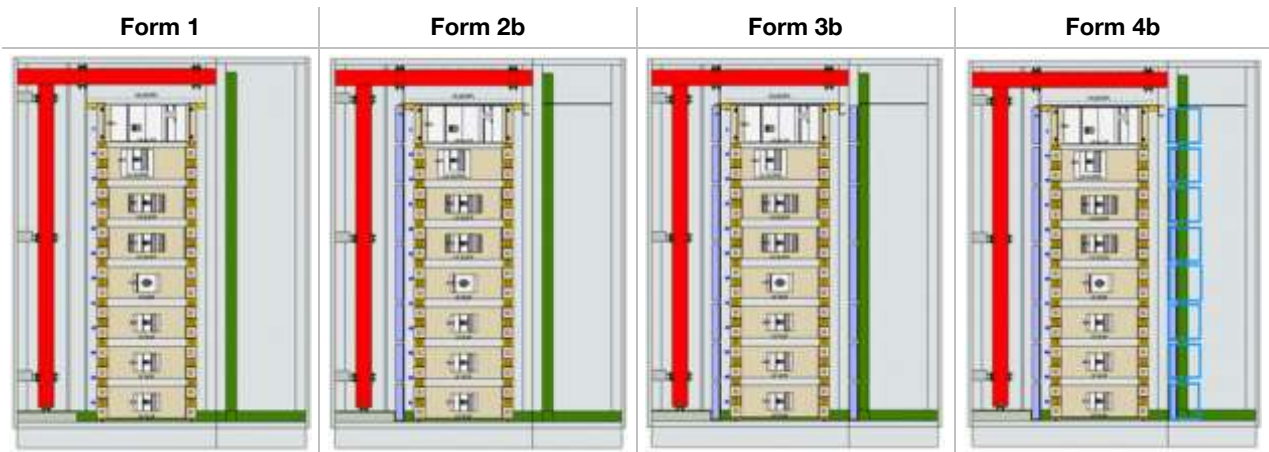

Horizontal orientation of MCCB

Rated current of the assembly I_{nA}	up to 1600 A
Rated conditional short-circuit current tested in the system I_{cc}	up to 70 kA
Depth of the enclosure	400 / 600 / 800 mm
Width of the enclosure	700 / 900 / 1000 mm
Height of the enclosure	1900 / 2100 mm
Mounting orientation of the device	horizontal
Mounting types of protection devices	fixed / plug-in / draw-out
Connection type	cable (top/bottom) / BTS (top)
Internal form of separation	1 / 2b / 3b / 4b
Service Index levels	IS111 - IS232

5.3.2.2.1 Neutral point treatment

TN-S System

For TN-S System, a choice between 4P devices or 3P devices is possible.

4P devices

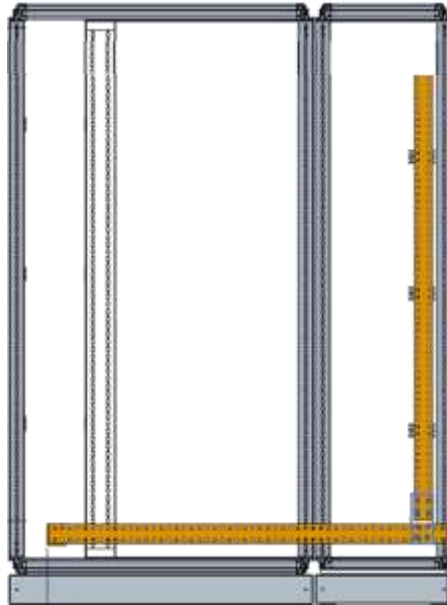

- In case of 4P devices, the N is located left on the device.
- The connection of PE is made inside the cable compartment, preferably to a common copper bar (e.g. UC922) that is fixed directly to the frame of the cell vertically, connecting to the horizontal PE bar arriving from the incoming cell.
- In case no cable compartment is used, the PE bar can also be located in the rear of the distribution compartment.

3P devices

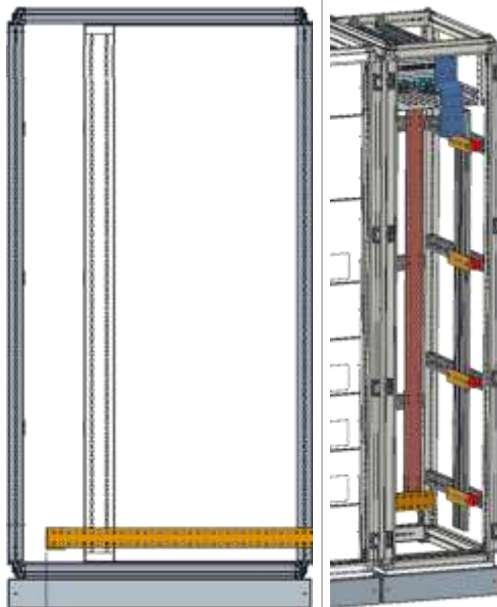

- In case of 3P devices, there are differences between Form 1-3b and Form 4b.
- In Form 1 up to Form 3b there is no need to separate the outgoing N terminals from each other, so the N and PE bars can be placed in the cable compartment, with UC*FU brackets to support the fixation.

TN-S System without cable compartment

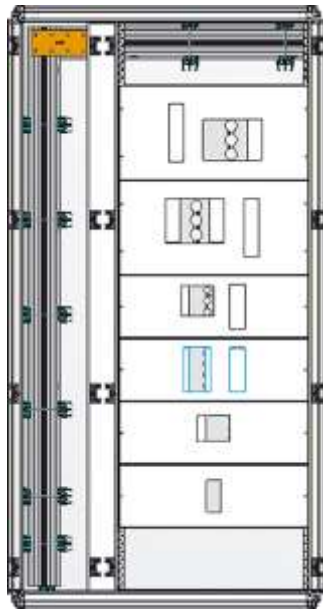

- In case a cable compartment is not used, the N terminals have to be placed inside the devices kits or connected directly from the N transfer busbar.
- The PE bar can also be located in the rear of the distribution compartment. We recommend to use rear connections on the outgoing terminals to ease the cabling.

TN-S System in Form 4b

In Form 4b it's necessary to separate the outgoing N terminals from each other. A cable compartment is mandatory in case front connections of devices are used.

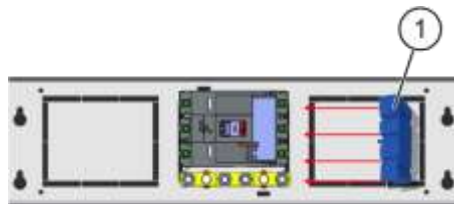

1 Disconnector link
(Schematic representation)

- The common PE bar can still be accommodated in the cable compartment, with UC*FU brackets to support the fixation.
- N is designed as Neutral link next to the MCCB, placed on the same side as it would be found on the 4P incomer.
- The N link and N link cover (disconnecter link) is available as accessory.

N disconnecter links



I_n [A]	Reference
160 SP *	JF160NDL25
160	JF160NDL
250	JF250NDL
400	JF400NDL
630	JF630NDL

* Single pole device

Terminal enclosures

The termination for the outgoing cables is to be done by Form 4b accessory box or touch protected terminals.



Height [mm]	Reference
H200	UC200CB
H300	UC300CB

TN-C System

For TN-C System, 3P devices must be used.

There are differences between Form 1-3b and Form 4b. In Form 1 up to Form 3b there is no need to separate the outgoing PEN terminals from each other, so the PEN bar can be placed in the cable compartment, with UC*FU brackets to support the fixation.

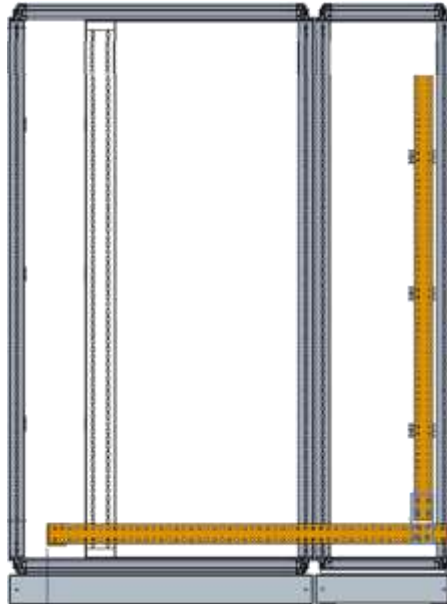

- In case a cable compartment is not used, the PEN bar runs together with the phases in the transfer busbar section.
- We recommend to use rear connections on the outgoing terminals to ease the cabling

TN-C System without cable compartment

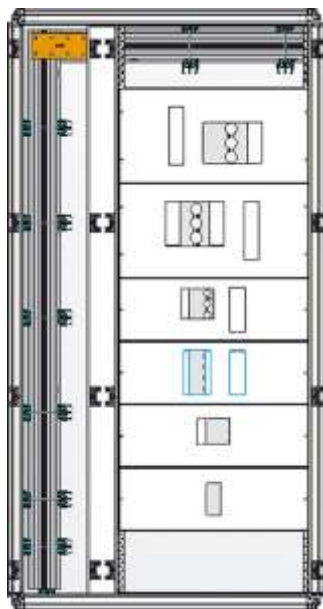

- In case a cable compartment is not used, the PEN bar runs together with the phases in the transfer busbar section.
- We recommend to use rear connections on the outgoing terminals to ease the cabling

TN-C System in Form 4b

In Form 4b it's necessary to separate the outgoing N terminals from each other. A cable compartment is mandatory in case front connections of devices are used.

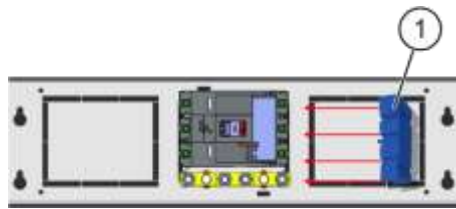

1 Disconnector link
(Schematic representation)

- N is designed as Neutral link next to the MCCB, placed on the same side as it would be found on the 4P incomer.
- The N link and N link cover (disconnecter link) is available as accessory.

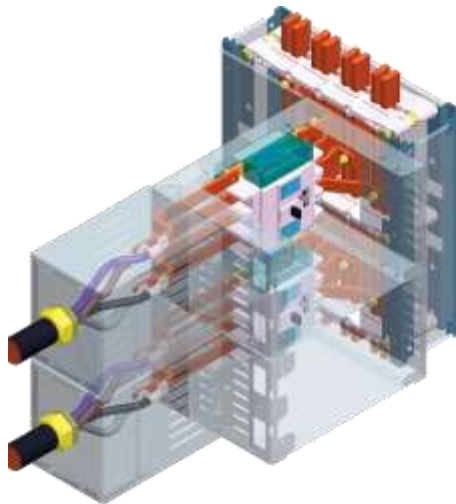

Terminal enclosure

- The termination for the outgoing cables is to be done inside the Form 4b segregation, just as the phases.

5.3.2.3 BS version

Outgoing in two ways

Outgoing sections can be built in two ways:

- compartmentalized MCCBs for forms of separation up to Form 4b type 7
- group mounted MCCBs for high density of outgoing MCCB circuits.

5.3.2.3.1 Compartmentalized MCCBs

The compartmentalized solution is based on standard quadro evo platform, with additional options to separate the outgoing terminals. The compartment can be orientated to left or right.

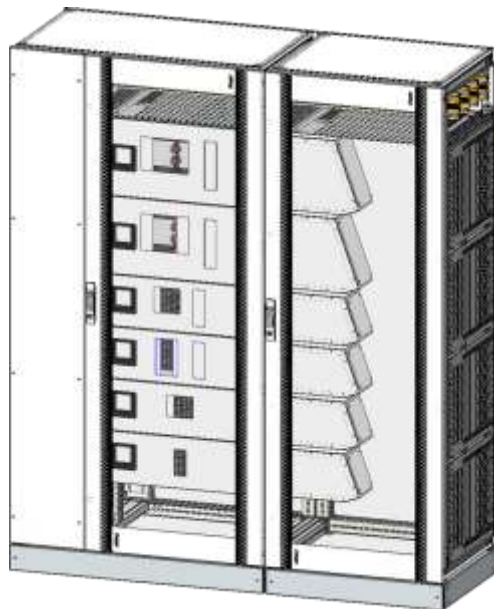

Characteristics

- IP30 (without door) / IP31 (with door & ventilated rear panel) / IP43 (modular doors) / IP55 (full door)
- Top & bottom main busbar
- Top & bottom out
- Only horizontal kits
- X1, P160, X2, P250, P630
- RCD extension can be accommodated (250 A & 400 A devices)
- Kit width: 600 & 800 mm
- Front access & rear access
- Form 4 type 2, 6 & 7
- Motorized MCCB reclosing possible
- 4P application (4P / 3P + neutral disconnection link)
- 2P application (SP + neutral disconnection link)
- Minimum 2 SP devices per kit
- CT possible to install within MCCB compartment
- DIN 96 metering possible to install within MCCB section
- Neutral disconnection link in case of 3P devices, located in same kit

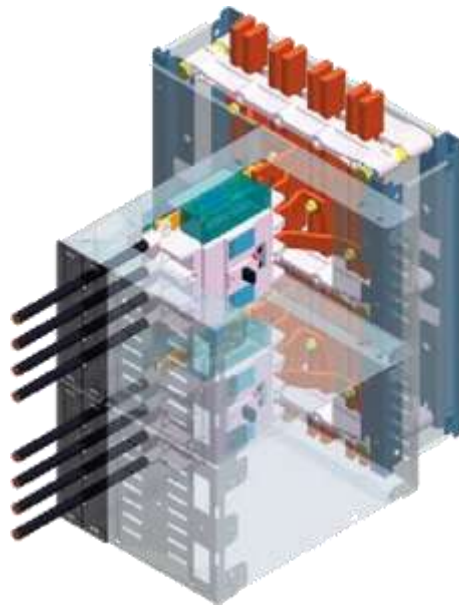
Form 4 type 2

- Horizontal kits, devices separated from each other and from main busbar, outgoing terminals covered by cable pass-through.

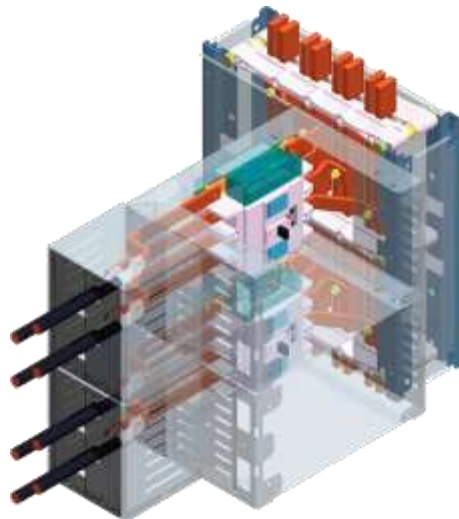
Form 4 type 6

- Horizontal kits, devices separated from each other and from main busbar, outgoing terminals in a separate compartment (metal housing).

Form 4 type 7

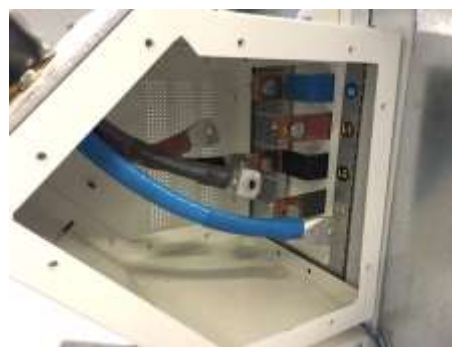
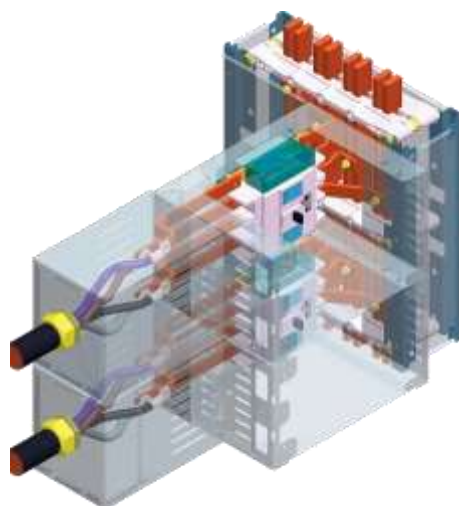

- Horizontal kits, devices separated from each other and from main busbar, outgoing terminals in a separate box for cable gland.

Rated values

Rated values measured for compartmentalized outgoing, distribution busbar 1600 A in the top of the compartment for supply:

Outgoing MCCB Frame	MCCB I _n Rating	IP Rating	Test Result I _{nc}	Cable size	Comments
x160 3P	160 A	IP31	130 A	1 x 50 mm ²	cable & flexi-bar
		IP43/55	115 A	1 x 50 mm ²	cable & flexi-bar
P160 3P	160 A	IP31	145 A	1 x 50 mm ²	Form 4b type 6: NDL = 140 A
		IP43/55	128 A	1 x 50 mm ²	Form 4b type 6: NDL = 122 A
P160 1P	125 A	IP31	-	1 x 50 mm ²	cable & flexi-bar
		IP43/55	-	1 x 50 mm ²	cable & flexi-bar
x250 3P	250 A	IP31	200 A	1 x 95 mm ²	Form 4b type 6: NDL = 190 A
		IP43/55	166 A	1 x 70 mm ²	
P250 3P	250 A	IP31	200 A	1 x 95 mm ²	
		IP43/55	175 A	1 x 70 mm ²	
x630 3P	400 A	IP31	299 A	1 x 185 mm ²	Single flexi-bar / Form 4b type 6: NDL = 295 A
		IP43/55	265 A	1 x 150 mm ²	Single flexi-bar / Form 4b type 6: NDL = 260 A
P630 3P	400 A	IP31	355 A	1 x 240 mm ²	Single flexi-bar / Form 4b type 6: NDL = 350 A
		IP43/55	321 A	1 x 185 mm ²	Single flexi-bar / Form 4b type 6: NDL = 322 A
x630 3P	630 A	IP31	415 A	2 x 150 mm ²	Single flexi-bar / Form 4b type 6
		IP43/55	344 A	1 x 240 mm ²	Single flexi-bar / Form 4b type 6
		IP31	460 A	2 x 150 mm ²	Double flexi-bar / Form 4b type 6
		IP43/55	401 A	2 x 150 mm ²	Double flexi-bar / Form 4b type 6
P630 3P	630 A	IP31	420 A	2 x 150 mm ²	Single flexi-bar / Form 4b type 6
		IP43/55	365 A	1 x 240 mm ²	Single flexi-bar / Form 4b type 6
		IP31	414 A	2 x 150 mm ²	Double flexi-bar / Form 4b type 6
		IP43/55	401 A	2 x 150 mm ²	Double flexi-bar / Form 4b type 6

5.3.2.3.2 Group mounted version

Two options for group mounted versions:

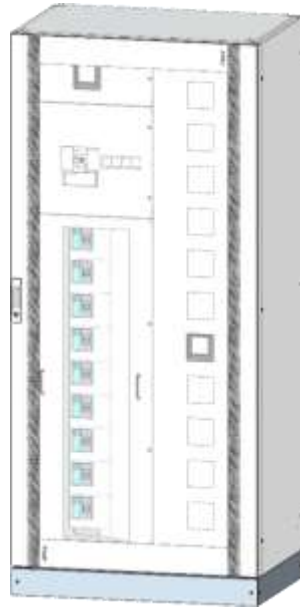

1 Standalone combined incoming and outgoing section within the same enclosure.



2 Outgoing section supplied from a main busbar.

Enclosure setup for standalone version

- Left & right setup
- Top & bottom feed
- Top & bottom out
- 4 pole busbar design (400 A & 800 A):
 - Direct feed from main busbar
- Standalone option with incomer and outgoer section
 - 400 A / 800 A MCCB incomer
- Short circuit level:
 - Busbar tested 40 kA I_{cw} 1s
- Form 4b type 6 group mounted
- IP30 (without door) / IP31 (with door & ventilated rear panel) / IP55 (full /glass door)

Outgoing ways

- 4P application (3P + neutral disconnection link)
 - h3 160 A frame size
 - h3+ 160 A frame size
 - h3 250 A frame size
 - h3+ 250 A frame size
- 2P application (SP + neutral disconnection link)
 - h3+ 160 A frame size

Enclosure setup for outgoing section supplied via main busbar version

- Left & right setup
- Top & bottom feed
- Top & bottom out
- 4 pole busbar design (400 A & 800 A):
 - Direct feed from main busbar
- Short circuit levels:
 - Main busbar tested 40 kA I_{cw} 1s
- Form 4 type 2 - 6 group mounted
- IP30 (without door) / IP31 (with door & ventilated rear panel) / IP43 (modular doors) / IP55 (full door)

Outgoing ways

- 4P application (3P + neutral disconnection link)
 - h3 160 A frame size
 - h3+ 160 A frame size
 - h3 250 A frame size
 - h3+ 250 A frame size
- 2P application (SP + neutral disconnection link)
 - h3+ 160 A frame size
-

Hinged front cover cable compartment

- Knockouts for DIN 96 metering
- Hinged in the middle of the enclosure to ease wiring meter wiring

Rated values

Rated values measured for compartmentalized outgoing, distribution busbar 1600 A in the top of the compartment for supply:

Outgoing MCCB Frame	MCCB I_n Rating	IP Rating	Test Result I_{nc}	Cable size	Test Result I_{ng}
x160 3P	160 A	IP31	132 A	1 x 50 mm ²	117 A
		IP43/55	130 A	1 x 50 mm ²	117 A
P160 3P	160 A	IP31	152 A	1 x 70 mm ²	120 A
		IP43/55	150 A	1 x 50 mm ²	120 A
x160 3P	125 A	IP31	125 A	1 x 50 mm ²	112,5 A
		IP43/55	125 A	1 x 50 mm ²	112,5 A
P160 3P	125 A	IP31	125 A	1 x 50 mm ²	112,5 A
		IP43/55	125 A	1 x 50 mm ²	112,5 A
P160 1P	125 A	IP31	125 A	1 x 50 mm ²	112,5 A
		IP43/55	125 A	1 x 50 mm ²	112,5 A
x250 3P	250 A	IP31	250 A	1 x 120 mm ²	232 A
		IP43/55	243 A	1 x 120 mm ²	225 A
P250 3P	250 A	IP31	250 A	1 x 120 mm ²	250 A
		IP43/55	250 A	1 x 120 mm ²	250 A

5.3.2.4 Outgoing enclosure vertical orientation of MCCBs

Benefit of vertical orientation

The benefit of the vertical orientation is that more devices can be fit inside the compartment, compared the horizontal orientation.

This configuration is the preferred solution for small outgoing devices as MCCBs ≤ 630 A, where the wiring must not be done in a dedicated cable compartment due to size of the cables. In this layout, the outgoing cables must be placed behind the devices, the supply is done via the busbar placed in the middle of the board. Thus the busbar can be located also in the top or bottom of the board. The outgoing cables should not cross the busbar compartment, or separated appropriately.

Notice: All examples visualized without covers, for better understanding

Forms of segregation



(*) Form 3b (left hand side compartment)

(**) Form 4b (right hand side compartment)

Vertical orientation of MCCBs

Rated current of the assembly I_{nA}	up to 1600 A
Rated conditional short-circuit current tested in the system I_{cc}	up to 70 kA
Depth of the enclosure	400 / 600 / 800 mm
Width of the enclosure	700 / 900 / 1000 mm
Height of the enclosure	1900 / 2100 mm
Mounting orientation of the device	vertical
Mounting types of protection devices	fixed / plug-in / draw-out
Connection type	cable (top/bottom) / BTS (top)
Internal form of separation	1 / 2b / (3b / 4b)*
Service Index levels	IS111 - IS211 (- IS232)*
*) only in case of single device per kit possible	

5.3.2.5 Outgoing enclosure, modular devices

DIN rail kit equipped with modular devices

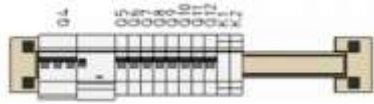

Transfer busbar and ventilation front cover in the bottom

Transfer busbar and plain front cover in the bottom

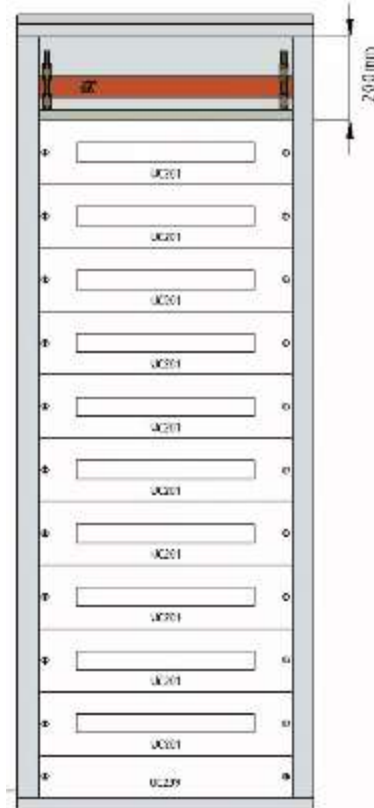
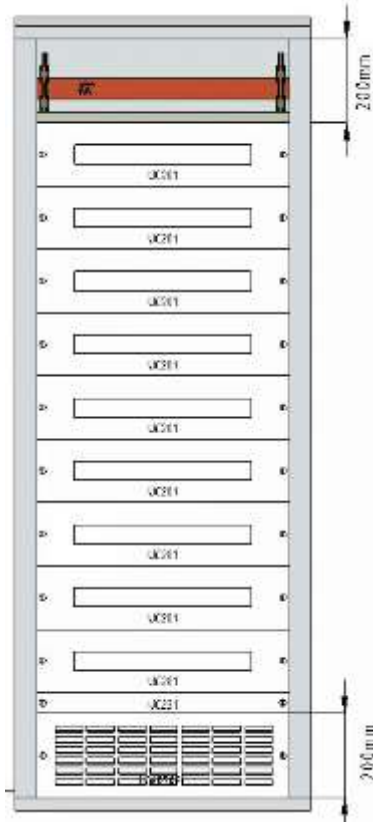

Full height used for modular kits

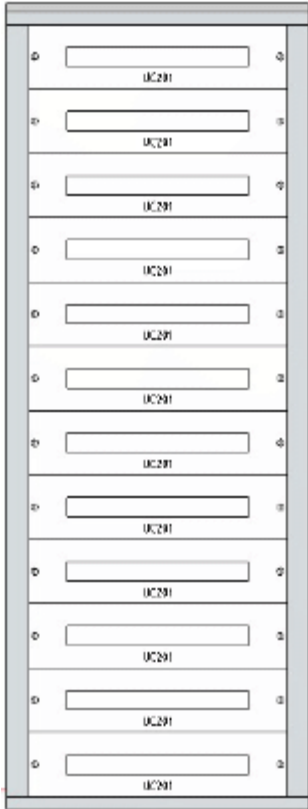

System kits of 200 mm and 150 mm in mix

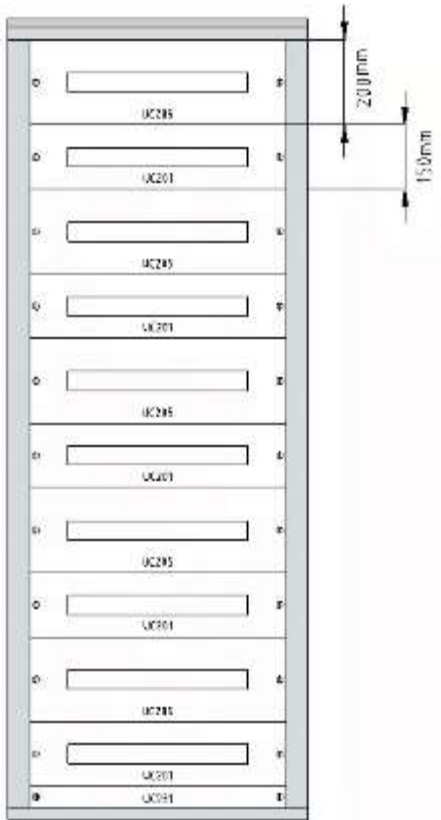

5.3.2.6 Connection and output terminals

Horizontal or vertical

Terminals can be fitted in DIN rail kit with plain cover in front of it or on a long DIN rail inside the cable compartment, vertically.

Horizontal fixing on kit

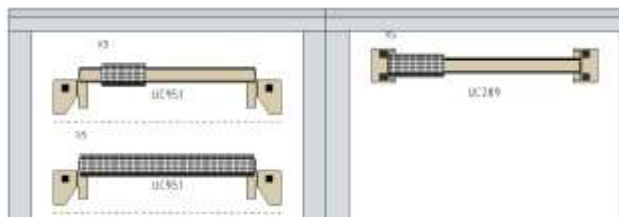

Vertical fixation in cable compartment

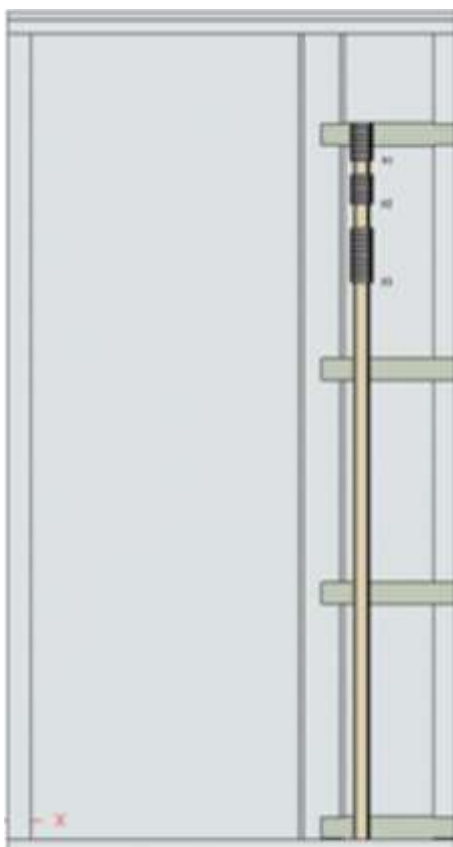

5.3.2.7 SX compartment

Dedicated compartment with SX components

To realize higher levels of Index Service (IS) such as IS223 and IS233, a dedicated compartment with SX components must be chosen. This outgoing compartment is limited to 2000 A nominal current output.

This compartment is built with a busbar in the rear of the board and dedicated kits “backbox” to plug-in the P160, P250, P630 or x630 version MCCBs. The power supply is done by “functional units” plug-in adapter, the outgoing are connected by cables directly on the device terminals in IS223 and via an additional plug-in adapter for IS233.

All functional units can be mixed in position and dimension.

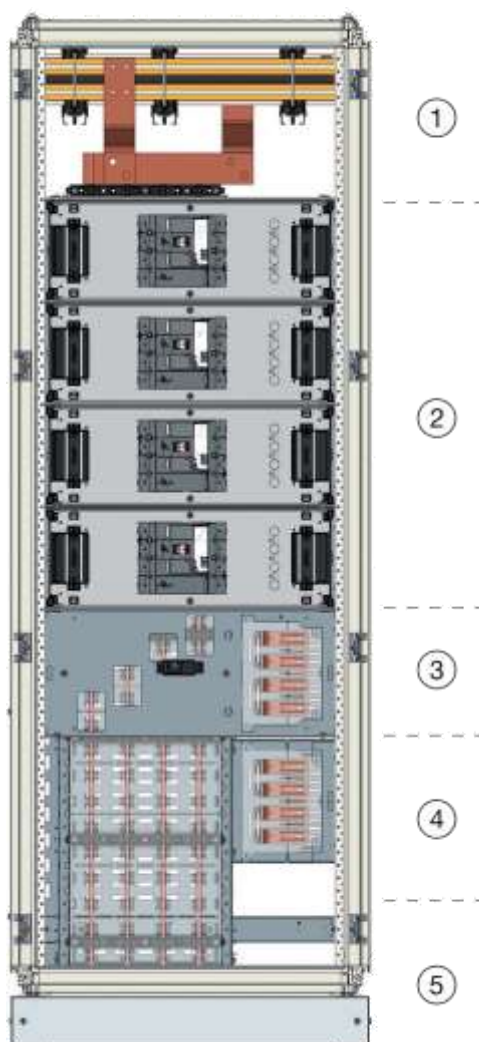

- | | |
|---|--|
| 1 | Area dedicated for transfer and connection links to SX busbar |
| 2 | Functional unit P630 or x630 (630 A) in front of backbox (not visible) |
| 3 | Backbox (spare) for P250 functional unit |
| 4 | SX busbar for power distribution and IS233 outgoing adapter |
| 5 | Spare area (optionally) for future adaptations |

Horizontal plug-in units for MCCBs

Rated current of the assembly I_{nA}	up to 2000 A
Rated conditional short-circuit current tested in the system I_{cc}	up to 70 kA
Depth of the enclosure	600 / 800 mm
Width of the enclosure	700 (+ 450 cable compartment) / 1000 mm
Height of the enclosure	1900 / 2100 mm
Mounting orientation of the device	horizontal
Mounting types of protection devices	plug-in
Connection type	cable (top/bottom) / BTS (top)
Internal form of separation	3b / 4b
Service Index levels	IS223 - IS233

5.4 Routine verification

Routine verification checklist

There are 9 verifications required to be realised by the assembly manufacturer as required by IEC / EN IEC 61439-1 clause 11.

1. Degree of protection of enclosures
Verify whether the protection rating (IP) complies with customer requirements. If devices or extended device handles are installed on the door, check that there is no IP degradation and that the IP complies with customer requirements. Cable gland plates for conductors, covers or screens on live parts, etc.
2. Clearances and creepage distances
Verify that the minimum clearance complies with the table in IEC / EN IEC 61439-1 clause 8.3.2.
If the clearance values are lower than those in the table, carry out a test.

Rated impulse withstand voltage U_{imp} (kV)	Minimum clearance (mm) up to 2000 m
≤ 2.5	1.5
4.0	3.0
6.0	5.5
8.0	8.0
12.0	14.0

1. Likewise, carry out a physical measurement or a test if clearances appear to be less than or equal to those in the table. Withstand voltage tests are not required if clearances are more than 1.5 times those given in the table.
Creepage distances: Verify that the minimum creepage distances comply with IEC / EN IEC 61439-1 clause 8.3.3 Table 2.
N.B.: Creepage distances can't be less than the corresponding minimum clearances.
2. Protection against electric shock and integrity of protective circuits
Verify the continuity and interconnection of the protective conductor (PE). Spot check the tightness of screwed and bolted connections. Check that the PSC earths are actually connected to the incoming external PE terminal and that the circuit resistance does not exceed 0.1 Ω .
3. Integration of built-in components
The installation and marking of built - in components must comply with the assembly manufacturing instructions. Compliance with safety zones, connection rules and wiring plan supplied by the switchgear manufacturer. Accessibility of actuators and controls. Device calibration.
4. Internal electrical circuits and connections
Spot check the tightness of connections, particularly those which are screwed or bolted.

5. **Terminals for external conductors**
Verify that the number, type and marking of terminals comply with the assembly manufacturing instructions. Suitability between conductor ranges and cross-sections. There is an obligation to indicate whether the terminals are suitable for copper or aluminium conductors or both. Conductor connectors must be clearly identified by colour-coding or alphanumeric marking.
6. **Mechanical function**
Check mechanical controls, locks and locking devices, including removable parts. Door closures and, where applicable, locks.
7. **Dielectric properties**
Carry out a 1 - second power-frequency withstand voltage test on all circuits. Extract from IEC / EN IEC 61439-1 Table 8, power - frequency withstand voltage.

Rated insulation voltage U_i between phases [V]	Dielectric test voltage [V]	
	AC [rms]	DC
$300 \leq U_i \leq 690$	1890	2670
$690 \leq U_i \leq 800$	2000	2830
$800 \leq U_i \leq 1000$	2200	3110

8. **Precautions: before carrying out the test, ensure that you disconnect devices that do not support the applied voltage (control circuits, electronic switchgear, contactor coils, electric actuators, indicator lights, miniature relays, measuring instruments, etc.).**
To do this, open the circuit breaker(s) or protective devices enabling a supply to the auxiliary circuits.
Perform this test with a dielectric meter to deliver the required voltage. Apply the voltage successively to each line-to-line and then line-to-earth.
The tests are OK if there is no insulation override, breakdown or rupture. For PSCs with a rated current less than or equal to 250 A, the insulation resistance can be measured using an insulation measuring device at a voltage of at least 500 V_{DC}.
In this case, the test is OK if the insulation resistance between the circuits and the earths is at least 1000 Ω/V referred to the supply voltage of the circuits to earth.
9. **Wiring, operational performance and function**
Inspect cables, verify and function check relays, carry out operational tests, etc.
Check that the location of and marking on devices and components is consistent with diagrams.
To carry out these checks, certain specific tools are required in addition to those normally used for assembly.
These are:
 - a tester or multimeter
 - a test bench (AC and DC) to supply the assembly during the live operation test
 - a torque wrench to check the tightening torques
 Tools must be calibrated at least once a year in order to guarantee reliable results.

5.4.1 Supporting document

Supporting document for the inspection

This document, though not exhaustive, helps to verify key points so that end users have an assembly in line with their requirements.

The HagerCad software 'Enclosure' module includes an example checklist.

Protocol for routine testing (routine testing protocol)
Sheet 1



- Power switch unit combination (PSC),
Type approval as per EN 61439-1/-2
- Distribution board (DBO),
Type approval as per EN 61439-1/-3

Company: _____

Order: _____

Project: _____

Type: _____

Documentation created:

Ser. no.	Test type	Content of test	EN 61439-1, Section	Result	Tested by
1	S	Cabinet/housing protection class (seals, covers)	11.2	<input type="text"/>	<input type="text"/>
2	S/P	Clearances and creepage distances	11.3	<input type="text"/>	<input type="text"/>
3	S/P	Protection against electric shock and conductivity of protective earth circuits	11.4	<input type="text"/>	<input type="text"/>
4	S	Installation of operating resources	11.5	<input type="text"/>	<input type="text"/>
5	S/P	Internal electrical circuits and connections	11.6	<input type="text"/>	<input type="text"/>
6	S	Connections for conductors routed in from outside	11.7	<input type="text"/>	<input type="text"/>
7	P	Mechanical function (actuators, locking devices)	11.8	<input type="text"/>	<input type="text"/>
8	P	Insulating properties	11.9	<input type="text"/>	<input type="text"/>
9	P	Wiring, operating behaviour and function Test voltage value	11.10	<input type="text"/>	<input type="text"/>

Testing of insulation strength at operating frequency must be performed on all electric circuits for the duration of one second pursuant to 10.9.2. The test voltage for switchgear combinations with a nominal insulation voltage between 300-690 V is 1890 V. The test values for deviating nominal insulation voltages are listed in Table 8 of IEC 61439-1.

Alternatively, the following applies for switchgear combinations with a protection device on the feed side and a nominal current of up to 250 A: measurement of the insulation resistance with an insulation measuring device at a voltage of at least 500 V DC. The test is deemed passed if the insulation resistance is at least 1000 Ω / V.

Explanation:
S = Visual inspection
P = Test with mechanical or electrical test equipment

Fitter: _____ Tested by: _____

Date: _____ Date: _____

Checklist for Conformity appraisal procedure sheet 2



Company: _____

Stamp

Order: _____

Project: _____

Type: _____

Low voltage switch unit combinations and distribution boards

Power switch unit combination (PSC),
Type approval as per EN 61439-1/-2

Distribution board (DBO),
Type approval as per EN 61439-1/-3

1. Technical documentation

Scope of the Low Voltage Directive 2000/95/EC

Lists or other documentation by the original equipment manufacturer for low voltage switch unit combinations or distribution boards (important content: name and address of original equipment manufacturer and type designation, applicable standard, description of product)

Assembly and installation instructions by original equipment manufacturer

Circuit diagram, layout drawing, bill of materials

Performance of routine testing as per EN 61439-1.
The test protocol for routine testing is an integral part of the documentation

Scope of the EMC Directive 2004/108/EC

Supplements the technical documentation by manufacturer's documentation for all electronic modules and devices that contain electronics (assembly and installation instructions)

Device manufacturer's Declaration of Conformity which confirms the compliance of the product with the requirements of the EMC Directive. A notice in the accompanying documentation is equivalent and must therefore be retained

2. Creating the Declaration of Conformity

3. Affixing the CE mark

Conformity appraisal procedure completed:

(Date and place of issue)

(Name and signature or equivalent mark of authorised person)

Declaration of conformity
Sheet 3



We, [company],

Stamp

declare in sole responsibility that the product:

- Small installation distribution board,
- Power switch unit combination
- Installation distribution board for operation by ordinary persons.

Designation, type, catalogue or order no.:

to which the present Declaration applies, fulfils and was manufactured in accordance with the following standard(s).

Low voltage switch unit combinations and distribution boards

- Power switch unit combination (PSC),
Type approval as per EN 61439-1/-2
- Distribution board (DBO),
Type approval as per EN 61439-1/-3

The designated product complies with the provisions of the following European Directives:

- Low Voltage Directive 2006/95/EC
- EMC Directive 2004/108/EC (e.g., for electronic operating resources built into switch unit combinations or distribution boards as per EN 61439-1/-2)

Date of affixing the CE mark* : ____/____/_____
(Date and place of issue)

* Visibly affixed to the low-voltage switch unit combination or distribution board in conjunction with the manufacturer's mark, may only be legible after opening the door.

With this Declaration of Conformity, the manufacturer confirms compliance with the stated directives and standards.
This Declaration of Conformity complies with EN 45014, "General Criteria for Declarations of Conformity by Suppliers".

(Date and place of issue)

(Name and signature or equivalent mark of authorised person)

5.5 Installing

Installing on floor

The location for the PSC must be prepared beforehand: the surface must be level as indicated below.

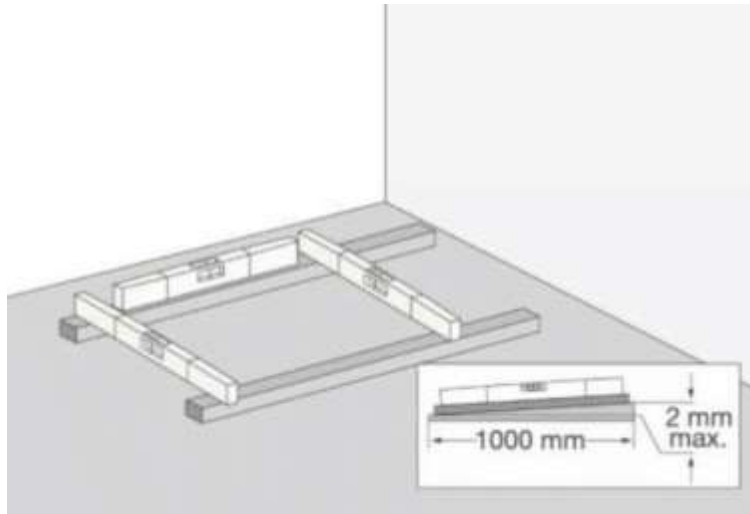

The plinths of the various cabinets must be fixed to the ground.

5.6 Connections

Cabel entries and connections

Cable entries must be provided at the top or bottom of the cabinet. The cables must be fixed mechanically from their entry into the cabinet and all the way along their path up to the connection point.

When making connections it is essential to observe the tightening torques given by the manufacturer.

Compare and check that the cable sections are in accordance with the calculation note.

Carefully consider how the various cables are to be connected to the various switchgear or terminal blocks.

Take into account the space required for each connection:

- Ends
- Switchgear terminals
- Extensions or spreaders

5.7 Commissioning

Commissioning by accredited persons

Commissioning must be by accredited persons with all the necessary experience and qualifications.

Before commissioning, visually check that all the connections and links between switchgear and busbars are securely fixed.

In case of doubt, check bolt tightening again with a torque wrench, applying a torque 15 % less than the torque given in the documents.

Special attention must be given to protective conductors and the various connecting links.

Check the ratings and thermal and magnetic settings of the various protection equipment against the calculation note.

Measure the insulation level of the equipment and the continuity of the protection circuit before switching on.

5.8 Maintenance

Maintenance accredited persons

Maintenance must be by accredited persons with all the necessary experience and qualifications.

Recommendation for periodic inspections

Cabinet and / or switch-gear	Interval	Type of inspection	Inspector
Cut-off and protection equipment (circuit breakers, switches etc.)	Every year	<ul style="list-style-type: none"> - Visual inspection - Mechanical manipulation cycle (ON – OFF) - Tightening check 	Accredited person
Whole equipment <ul style="list-style-type: none"> - Cabinets - Busbars - Cut - off and protection equipment - Terminal blocks, etc. 	Every 4 years	<ul style="list-style-type: none"> - Visual inspection - Proper functioning of the systems - Dust the inside of the cabinets: <ul style="list-style-type: none"> - busbars - switchgear - Check busbar connections - Check the proper functioning of the switchgear: <ul style="list-style-type: none"> - thermal - magnetic - residual current 	Accredited person

6 Index

A

- Abbreviations • 12
- About this manual • 6
- ACB air circuit breaker • 215
- Accessibility • 267
- Accessory for enclosure • 65
- Air clearances and creepage distances • 243
- Aluminium busbar accessories • 148
- Aluminium busbar and Service Index 223 & 233 - Technical data • 147
- Aluminium busbars, enclosure depth 400 mm - Technical data • 143
- Aluminium busbars, enclosure depth 600 mm - Technical data • 145
- Aluminium extruded busbar • 141
- Assignment of minimum cross-sections • 263
- Authorised persons • 15

B

- Barriers • 268
- Basic definitions • 248
- BS version • 365
- Bundling of equipment • 297
- Busbar and busbar supports • 66

C

- Cabinet characteristics • 33
- Cabinet system for PSC • 17
- Cable trunking • 228
- Circuit breaker kit product codes • 179
- Commissioning • 383
- Compartmentalized MCCBs • 365
- Component overviews • 35
- Conclusion • 295
- Conductors and busbars • 293
- Connection and output terminals • 373
- Connections • 382
- Connections for conductors inserted from the outside • 270
- Copper busbar • 81
- Copper busbars and Service Index 223 & 233 - Technical data • 129
- Copper busbars, enclosure depth 400 mm - Technical data • 83
- Copper busbars, enclosure depth 600 mm - Technical data • 93
- Copper busbars, enclosure depth 800 mm - Technical data • 105
- Copper manufacturing • 66

D

- Dedicated parts for Service Index 223 / 233 • 174
- Design and construction of a distribution assembly • 18
- Design verification • 287
- Design verification according to IEC / EN IEC 61439 • 234
- Direction of actuation and indicating switch positions • 268
- Distribution > 630 A 'transfer' • 331
- Distribution ≤ 630 A 'standard' • 330

E

- Earthing connection in quadro evo modular stand-alone distributors for rated currents > 630 A • 262
- Earthing connection in quadro evo modular stand-alone distributors for rated currents ≤ 250 A • 258
- Earthing connection in quadro evo modular stand-alone distributors for rated currents ≤ 630 A • 260
- Electromagnetic compatibility (EMC) • 282
- Enclosures • 33

F

- Field of application • 294
- Fixation on horizontal uprights • 57
- Fixing to the ground • 58
- Forms of internal separation • 155
- Front covers • 54
- Functional units • 179
- Functional uprights • 55
- Fuse LT • 225

G

- General information • 256
- General safety instructions • 22
- General Specifications • 32
- General terms • 13
- Group mounted version • 368

I

- Implementing protective conductor and earthing connections in switchgear and controlgear assemblies • 256
- Imprint • 9
- Incoming enclosures configurations • 329
- Incoming on multiple MCCB / Switch ≤ 630 A • 340
- Indicator lights and push buttons • 268
- Inserts • 266
- Installation of equipment • 266, 267
- Installing • 382
- Insulation properties • 272
- Intended use • 20
- Internal electrical circuits and connections • 269
- IP30 protection rating • 37
- IP31 protection rating • 41
- IP43 protection rating • 43
- IP55 protection rating • 46

L

- Labelling and label panels • 246
- Lateral interconnection of cells • 49
- Lifting and handling • 64

M

- Main incoming > 630 A and ATS to secondary distribution busbar system • 351
- Main incoming > 630 A from transformer and ACB backup supply • 348
- Main incoming > 630 A from transformer and ATS backup supply • 346
- Main incoming ≤ 630 A and ATS to secondary distribution busbar system • 352
- Main incoming ≤ 630 A from transformer and ATS backup supply • 345
- Main incoming ≤ 630 A from transformer and MCCB backup supply • 350

- Main incoming devices > 630 A • 342
- Main incoming devices ≤ 630 A • 344
- Maintenance • 384
- Maintenance and assembly • 285
- MCB • 226
- MCCB (Moulded Case Circuit Breaker) • 180
- MCCB 800 A ≤ 1600 A incoming • 336
- Mechanical function • 284
- Method 1
 - Adjusting the power loss (Pv) of built-in equipment with the permissible power loss (Pperm) of the enclosures • 301
- Method 2
 - Determining heating inside the switchgear and controlgear assembly • 305
- Misuse • 21
- Mobility index • 169
- Mounting and fixation • 76
- Mounting plate • 227
- Multiple incoming sources on common busbar • 338
- Multiple incoming with change over • 351
- Multiple incoming with switch between two busbar systems • 342
- Multiple incoming with switch over • 345
- Multiple main incoming > 630 A + coupling + ATS on 3 busbars • 353
- Multiple main incoming > 630 A and ACB backup supply on 2 busbars • 355
- Multiple main incoming ≤ 630 A + coupling + ATS on 3 busbars • 354
- Multiple main incoming ≤ 630 A and MCCB backup supply on 2 busbars • 355
- N**
- Network types • 251
- Neutral point treatment • 332, 360
- Notes on reducing power loss in enclosures • 294
- O**
- Observe related documents • 8
- Original manufacturer & SCA manufacturer • 233
- Outgoing enclosure horizontal orientation of MCCBs • 359
- Outgoing enclosure vertical orientation of MCCBs • 370
- Outgoing enclosure, modular devices • 371
- Outgoing enclosures configurations • 356
- P**
- Permissible power loss of enclosures • 318
- Permissible weights • 60
- Planning and installation • 230
- Power loss of busbar systems • 326
- Principle of outgoing enclosures configurations • 358
- Protection against electric shock & continuity of protective conductor circuits • 248
- Protection classes • 241, 250
- Protection classes for covers • 240
- Protective conductor (PE) • 264
- Protective conductor measures for rated currents > 630 A • 261
- Protective conductor measures for rated currents ≤ 630 A • 259
- Purpose of the manual • 7
- Q**
- quadro evo overview • 29
- quadro evo system presentation and overview • 28
- quadro evo technical information and characteristics • 286
- R**
- Removable parts • 266
- Routine verification • 376
- Routine verification according to IEC / EN IEC 61439 • 237
- S**
- Safety • 19
- Safety precautions • 25
- Selecting the equipment • 266
- Separation parts • 155
- Service index • 170
- Service index ratings • 171
- Service Index ratings of internal system • 173
- Short-circuit resistance of the protective conductor • 281
- Side and rear panels • 52
- Single ACB incoming compartment • 334
- Single incoming • 334
- Standards, verifications and certificates • 231
- Supporting document • 378
- SWITCH + ATS • 217
- Switch 630 A ≤ 1600 A incoming • 337
- SX compartment • 374
- System kits references for fixation of MCCBs in the enclosure. • 181
- T**
- Type of enclosure, enclosure materials • 293
- Types of functional units • 169
- U**
- Used symbols and trademarks • 11
- Using top-hat rails as protective conductor busbars • 265
- V**
- Verification by tests of the original manufacturer • 328
- Verification of short-circuit resistance • 275
- Verification of short-circuit resistance by applying the design rules • 280
- Verification of temperature rise in low-voltage switchgear and controlgear assemblies • 293
- Verification of temperature rise with the quadro evo system • 296

**Hager Electro GmbH Co. KG**

Zum Gunterstal
66440 Blieskastel
Germany
+49 6842 9450
info@hager.de
www.hager.de

Hager Electro S.A.S.

132, boulevard d'Europe B.P. 78
67215 Obernai
France
+33 (0)3 88 49 50 50
info@hager.fr
www.hager.fr

N.V. Hager Modulec S.A.

Noordkustlaan 16C
1702 Groot-Bijgaarden
Belgium
+32 2 5294711
Info@hager.be
www.hager.be

Hager Ltd.

Hortonwood 50
Telford, Shropshire
TF1 7FT
United Kingdom
+44 1952 675612
sales@hager.co.uk
www.hager.co.uk

Hager Bocchiotti S.p.A.

Via dei Valtorta, 48
20127 Milano
Italy
+39 02 70 15 05 11
info@hager-bocchiotti.it
www.hager-bocchiotti S.p.A.

Hager - Sistemas Eléctricos Modulares, S.A.

Sintra Business Park, Edifício 5, Fracção A
Zona Industrial da Abrunheira
2710-089 Sintra
Portugal
+351 21 44 58 450
info@hager.pt
www.hager.pt

Hager Sistemas, S.A.

Calle Alfred Nobel 18
Pol. Ind. Valldoríolf
08430 La Roca del Vallès
Spain
+34 938 424 730
infoweb@hager.es
www.hager.es